

PRICE \$1.00

HEATHKIT[®] ASSEMBLY MANUAL

HEATH COMPANY

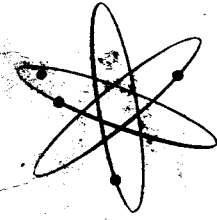

WIRELESS INTERCOM

MODEL GD-51

RESISTOR AND CAPACITOR COLOR CODES

RESISTORS

The colored bands around the body of a color coded resistor represent its value in ohms. These colored bands are grouped toward one end of the resistor body. Starting with this end of the resistor, the first band represents the first digit of the resistance value; the second band represents the second digit; the third band represents the number by which the first two digits are multiplied. A fourth band of gold or silver represents a tolerance of $\pm 5\%$ or $\pm 10\%$ respectively. The absence of a fourth band indicates a tolerance of $\pm 20\%$.

The physical size of a composition resistor is related to its wattage rating. Size increases progressively as the wattage rating is increased. The diameters of 1/2 watt, 1 watt and 2 watt resistors are approximately 1/8", 1/4" and 5/16", respectively.

The color code chart and examples which follow provide the information required to identify color coded resistors.

COLOR	1ST DIGIT	2ND DIGIT	MULTIPLIER
BLACK	0	0	1
BROWN	1	1	10
RED	2	2	100
ORANGE	3	3	1,000
YELLOW	4	4	10,000
GREEN	5	5	100,000
BLUE	6	6	1,000,000
VIOLET	7	7	10,000,000
GRAY	8	8	100,000,000
WHITE	9	9	1,000,000,000
GOLD	-	-	.1
SILVER	-	-	.01

EXAMPLES

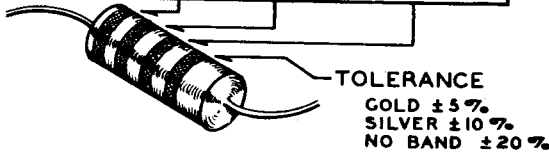
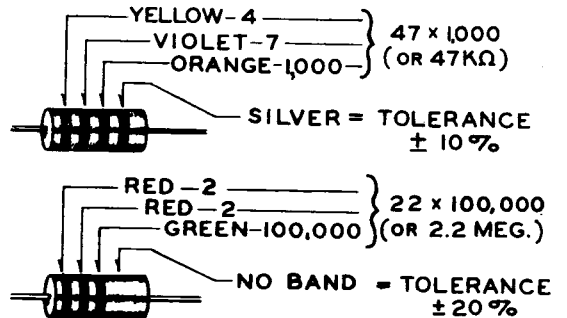

CAPACITORS

Generally, only mica and tubular ceramic capacitors, used in modern equipment, are color coded. The color codes differ somewhat among capacitor manufacturers, however the codes

shown below apply to practically all of the mica and tubular ceramic capacitors that are in common use. These codes comply with EIA (Electronics Industries Association) Standards.

MICA

COLOR	1ST DIGIT	2ND DIGIT	MULTIPLIER	TOLER. %
BLACK	0	0	1	± 20
BROWN	1	1	10	± 20
RED	2	2	100	± 2
ORANGE	3	3	1,000	± 3
YELLOW	4	4	10,000	—
GREEN	5	5	—	± 5
BLUE	6	6	—	—
VIOLET	7	7	—	—
GRAY	8	8	—	—
WHITE	9	9	—	—
GOLD	-	-	.1	—
SILVER	-	-	.01	± 10

EXAMPLE

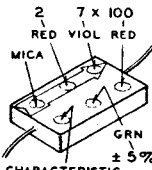

2,700 μ fd $\pm 5\%$
OR .0027 μ fd

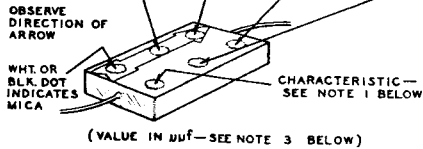

TUBULAR CERAMIC

Place the group of rings or dots to the left and read from left to right.

COLOR	1ST DIGIT	2ND DIGIT	MULTIPLIER	TOLER. %
BLACK	0	0	1	± 20 OR LESS OVER 10
BROWN	1	1	10	± 20 ± 20
RED	2	2	100	± 0.1 ± 1
ORANGE	3	3	1,000	— ± 2
YELLOW	4	4	10,000	— ± 2.5
GREEN	5	5	—	± 0.5 ± 5
BLUE	6	6	—	—
VIOLET	7	7	—	—
GRAY	8	8	—	± 0.25 ± 10
WHITE	9	9	—	—

EXAMPLE

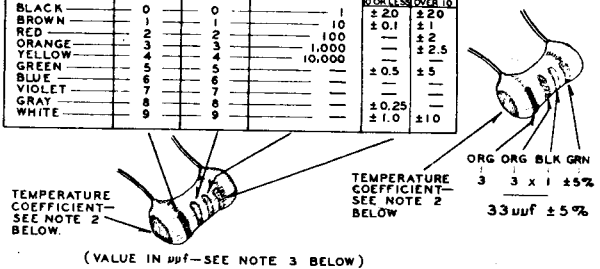

NOTES:

1. The characteristic of a mica capacitor is the temperature coefficient, drift capacitance and insulation resistance. This information is not usually needed to identify a capacitor but, if desired, it can be obtained by referring to EIA Standard, RS-153 (a Standard of Electronic Industries Association.)

2. The temperature coefficient of a capacitor is the predictable change in capacitance with temperature change and is

expressed in parts per million per degree centigrade. Refer to EIA Standard, RS-198 (a Standard of Electronic Industries Association.)

3. The farad is the basic unit of capacitance, however capacitor values are generally expressed in terms of μ fd (microfarad, .000001 farad) and $\mu\mu$ fd (micro-micro-farad, .000001 μ fd); therefore, 1,000 $\mu\mu$ fd = .001 μ fd, 1,000,000 $\mu\mu$ fd = 1 μ fd.

USING A PLASTIC NUT STARTER

A plastic nut starter offers a convenient method of starting the most used sizes: 3/16" and 1/4" (3-48 and 6-32). When the correct end is pushed down over a nut, the pliable tool conforms to the shape of the nut and the nut is gently held while it is being picked up and started on the screw. The tool should only be used to start the nut.

6-32



3-48



Assembly
and
Operation
of the



**WIRELESS
INTERCOM
MODEL GD-51**

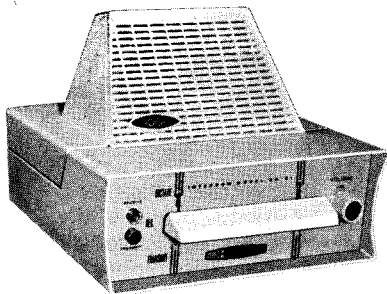

**HEATH COMPANY,
BENTON HARBOR,
MICHIGAN**



TABLE OF CONTENTS

Specifications.	2
Introduction.	2
Circuit Description.	2
Construction Notes.	3
Parts List.	4
Proper Soldering Techniques.	6
Step-By-Step Procedure.	8
Step-By-Step Assembly.	8
Parts Mounting.	8
Preliminary Chassis Wiring.	10
Underchassis Wiring.	13
Component Installation.	15
Initial Test.	20
Final Assembly.	20
Operation.	20
In Case Of Difficulty.	22
Service Information.	23
Service.	23
Replacements.	24
Shipping Instructions.	24
Warranty.	25
Schematic.	25*

*Fold-out from page.

All prices are subject to change without notice. The Heath Company reserves the right to discontinue instruments and to change specifications at any time without incurring any obligation to incorporate new features in instruments previously sold.



SPECIFICATIONS

Channel Frequencies.	180 kc or 220 kc, switch-selected.
Operation.	Two or more units may be used on the same power line.
Transistor-Diode Complement.	4 - 2N1274 transistors. 2 - Crystal diodes. 1 - Metal bridge rectifier.
Controls.	VOLUME, Receive. DICTATE-REC-TRANSMIT bar.
Power Requirements.	105 to 125 volts AC or DC, 2.5 watts standby.
Size.	8" wide x 6-1/4" high x 7-1/2" deep.
Net Weight.	2-1/2 lbs.
Shipping Weight.	4 lbs.

INTRODUCTION

Your HEATHKIT Wireless Intercom uses the power line as the interconnecting wiring. The Intercom can be used on either an AC or DC power line. Any number of Intercoms, from two up, can be used. Their locations can be changed easily without any changing in wiring. The distance between the units is limited only by the location of power line transformers, when used on an AC power source.

The Intercoms should always be plugged in as they require very little power when in the REC (receive) position. The volume cannot be turned completely down, therefore, they are always ready to use.

Each Intercom is a master station, therefore, when one station is used to transmit, all of the other Intercom stations receive the message; this makes the Intercom system ideal for paging operation.

The many possible uses for the Intercom include room-to-room and "babysitting" operation in the home, interoffice communication, and point-to-point operation in the small factory. Any number of applications can be found for two or more Intercom stations operated from the same power line.

CIRCUIT DESCRIPTION

The Intercom incorporates circuits for receiving and transmitting, plus a power supply. Each circuit will be covered separately for clarity. For a better understanding of how the Intercom works, refer to the Schematic Diagram while reading this description.

RECEIVE

When an Intercom functions as a receiver, the transistors operate as follows: X1 as an RF amplifier, X2 as a squelch circuit, X3 as the 1st audio amplifier, and X4 as an audio power amplifier.

The transmitted signal from another Intercom station is picked up from the power line by the receiving Intercom. Coils L1 and L2B, and series capacitor C4 form a tuned circuit to accept the signal. With the CHANNEL switch in the HI position, the frequency of the tuned circuit is 220 kc. With the CHANNEL switch in the LO position, capacitor C4 is parallel with capacitor C3 and the tuned circuit frequency becomes 180 kc. For this reason, the CHANNEL switch of all units operated together must be in the same position. Additional Intercom stations can be operated as a separate system on the other frequency.

The received signal is coupled from L2B to L2D, and through resistor R3 and capacitor C6 to transistor amplifier X1. The amplified signal from X1 is coupled through interstage transformer T1 to diode D2, which removes the 220 kc (or 180 kc) signal and leaves only the voice frequencies (audio). The audio signal is next applied to Volume control R11. When the Volume control is turned clockwise, the amount of audio signal applied to transistor X3 is increased.

The audio frequencies are amplified by X3 and then by X4, the power output transistor. Finally, the audio signal is coupled through output transformer T2 to the speaker.

Transistor X2 works as a squelch, or signal switching circuit. With no signal being received, X2 turns off 1st audio amplifier X3 so that the Intercom is completely silent. When a signal is

received, X3 is turned on and operates as described above.

TRANSMIT

When the Intercom functions as a transmitter, the transistors operate as follows: X2, X3, and X4 all serve as audio amplifiers, and X1 operates as an oscillator and RF output stage.

Sound is picked up by the speaker, which now operates as a microphone. The sound is converted by the microphone into an audio signal which is fed to transistor amplifier X2. After X2, the signal is amplified further by X3 and X4. The greatly amplified audio signal is then applied from the primary of transformer T2 to coil L2A, and then to oscillator-modulator stage X1. In X1, the oscillator frequency of either 220 kc or 180 kc, depending on which channel is used, is modulated by the audio signal.

Coils L2C and L2B are then used to couple this signal to the power line.

POWER SUPPLY

The power supply is a conventional full-wave bridge circuit, which provides excellent regulation with essentially no ripple. When transmitting, resistors R22 and R23 are connected in parallel to provide a lower dropping resistance and, thus, a higher DC output of the power supply. The fuse is a piece of #39 or #40 wire connected between lugs 3 and 2 of line coil L1.

CONSTRUCTION NOTES

This manual is supplied to assist you in every way to complete your kit with the least possible chance for error. The arrangement shown is the result of extensive experimentation and trial. If followed carefully, the result will be a stable instrument, operating at a high degree of dependability. We suggest that you retain the manual in your files for future reference, both in the use of the instrument and for its maintenance.

UNPACK THE KIT CAREFULLY AND CHECK EACH PART AGAINST THE PARTS LIST. In so doing, you will become acquainted with the parts.

Refer to the charts and other information on the inside covers of the manual to help you identify the components. If some shortage or parts damage is found in checking the Parts List, please read the Replacement section and supply the information called for therein. Include all inspection slips in your letter to us.

Resistors generally have a tolerance rating of 10% unless otherwise stated in the Parts List. Tolerances on capacitors are generally even greater. Limits of +100% and -20% are common for electrolytic capacitors.

We suggest that you do the following before work is started:

1. Lay out all parts so that they are readily available.
2. Provide yourself with good quality tools. Basic tool requirements consist of a screwdriver with a 1/4" blade; a small screwdriver with a 1/8" blade; long-nose pliers; wire cutters, preferably separate diagonal cutters; a pen knife or a tool for stripping insulation from wires; a soldering iron (or gun) and rosin core solder. A set of nut drivers and a nut starter, while not necessary, will aid extensively in construction of the kit.

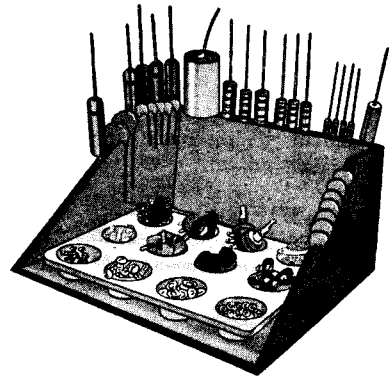

Most kit builders find it helpful to separate the various parts into convenient categories. Muffin tins or molded egg cartons make convenient trays for small parts. Resistors and capacitors may be placed with their lead ends in-

serted in the edge of a piece of corrugated cardboard until they are needed. Values can be written on the cardboard next to each component. The illustration shows one method that may be used.

PARTS LIST

NOTE: The circled numbers in the Parts List are keyed to the circled numbers on the pictures of the parts to aid in parts identification.

<u>PART No.</u>	<u>PARTS Per Kit</u>	<u>DESCRIPTION</u>	<u>PART No.</u>	<u>PARTS Per Kit</u>	<u>DESCRIPTION</u>
<u>Resistors</u>			<u>Resistors (cont'd.)</u>		
✓1-3	2	100 Ω 1/2 watt (brown-black-brown)	✓1-20	2	10 KΩ 1/2 watt (brown-black-orange)
✓1-45	1	220 Ω 1/2 watt (red-red-brown)	✓1-21	2	15 KΩ 1/2 watt (brown-green-orange)
✓1-4	1	330 Ω 1/2 watt (orange-orange-brown)	✓1-23	1	27 KΩ 1/2 watt (red-violet-orange)
✓1-48	1	390 Ω 1/2 watt (orange-white-brown)	✓1-24	1	33 KΩ 1/2 watt (orange-orange-orange)
✓1-9	2	1000 Ω 1/2 watt (brown-black-red)	✓1-47	1	56 KΩ 1/2 watt (green-blue-orange)
✓1-11	1	1500 Ω 1/2 watt (brown-green-red)	✓1-26	1	100 KΩ 1/2 watt (brown-black-yellow)
✓1-44	2	2200 Ω 1/2 watt (red-red-red)	✓2 3G-21	2	4700 Ω 7 watt wire-wound
✓1-13	1	2700 Ω 1/2 watt (red-violet-red)			
✓1-14	3	3300 Ω 1/2 watt (orange-orange-red)			
✓1-16	1	4700 Ω 1/2 watt (yellow-violet-red)			
✓1-18	1	5600 Ω 1/2 watt (green-blue-red)			

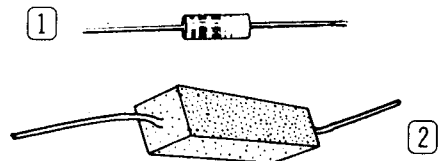

PART No.	PARTS Per Kit	DESCRIPTION
----------	---------------	-------------

Capacitors

20-125	1	240 μf silver mica
20-126	1	255 μf silver mica
20-128	2	470 μf silver mica
20-127	1	1300 μf silver mica
20-129	1	2700 μf silver mica
21-26	1	.003 μf disc ceramic
21-27	2	.005 μf disc ceramic
21-82	4	.02 μf disc ceramic
21-94	4	.05 μf disc ceramic
21-95	2	.1 μf disc ceramic
23-52	1	.047 μf tubular molded
25-123	2	2 μf tubular electrolytic
25-54	1	10 μf tubular electrolytic
25-55	2	50 μf tubular electrolytic
25-104	2	200 μf tubular electrolytic

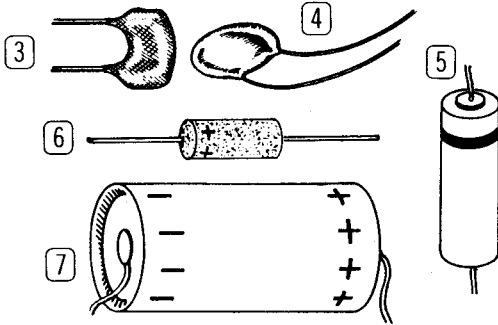

Control-Switches

10-119	1	10 K Ω control
60-16	1	3-pole double-throw slide switch
62-19	1	Lever switch (spring return)
62-20	1	Lever switch

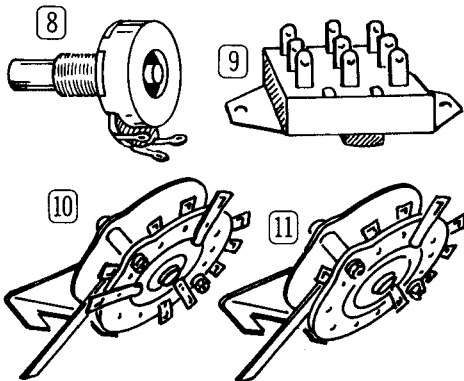

Coils-Transformers-Choke

40-434	1	Line coil
45-3	2	RF choke
40-435	1	Oscillator coil
51-87	1	Audio output transformer
52-51	1	Interstage transformer

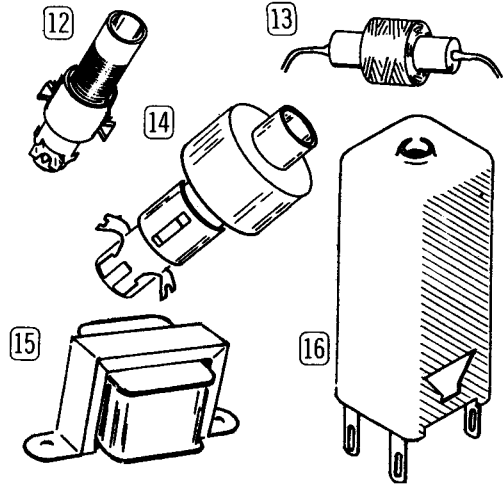

Diodes-Rectifiers-Transistors

56-4	2	Crystal diode
57-12	1	Metal bridge rectifier
73-4	1	Rubber grommet
117-2	1	Packaged transistor set consisting of four 2N1274 transistors

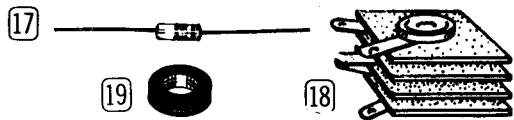

Hardware

250-8	4	#6 x 3/8" sheet metal screw
250-13	1	6-32 x 1" screw
250-49	8	3-48 x 1/4" screw
250-56	3	6-32 x 1/4" screw
250-89	3	6-32 x 3/8" screw
250-138	3	6-32 x 3/16" screw
250-170	5	#6 x 1/4" sheet metal screw

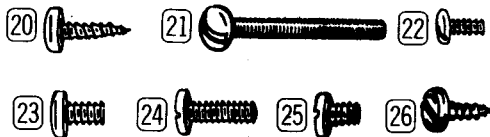

PART No.	PARTS Per Kit	DESCRIPTION
----------	---------------	-------------

Hardware (cont'd.)

✓ 252-1	8	3-48 nut
✓ 252-3	6	6-32 nut
✓ 252-7	1	Control nut
✓ 252-15	8	4-40 nut



✓ 252-22	2	6-32 speednut
✓ 252-32	2	Push-on speednut

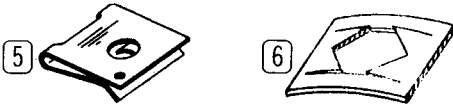

✓ 253-10	1	Control flat washer
✓ 253-27	1	5/16" flat washer
✓ 254-1	6	#6 lockwasher
✓ 254-5	2	Control lockwasher
✓ 254-7	14	#3 lockwasher
✓ 254-9	8	#4 lockwasher

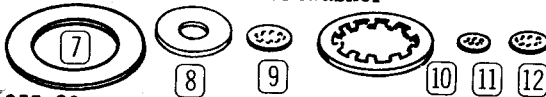

✓ 255-30	1	Spacer
✓ 260-7	1	Transformer mounting clip
✓ 260-26	1	Transistor mounting clip

Wire-Slewing

✓ 89-1	1	Line cord
✓ 344-1	3	Length hookup wire: 1-red, 1-green, 1-yellow
✓ 346-1	1	Length slewing

PART No.	PARTS Per Kit	DESCRIPTION
----------	---------------	-------------

Metal Parts

100-M372F683

✓ 200-M341	1	Front panel
✓ 202-M40	1	Chassis
✓ 202-M41	1	Chassis left end plate
✓ 202-M41	1	Chassis right end plate
✓ 204-M274	1	Speaker bracket

Miscellaneous

✓ 92-31	1	Cabinet base
✓ 92-32	1	Cabinet top
✓ 207-5	1	Plastic clamp
✓ 391-8	1	Oval nameplate
✓ 401-30	1	Speaker
✓ 412-12	1	Clear pilot lamp
✓ 412-13	1	Red pilot lamp
✓ 431-3	1	3-lug terminal strip
✓ 431-38	1	3-lug terminal strip (miniature)
✓ 431-19	1	5-lug terminal strip
✓ 431-49	3	11-lug terminal strip
✓ 462-169	1	Bar knob
✓ 462-170	1	Round knob
✓ 485-10	1	Plug button
✓ 490-1	1	Alignment tool
✓ 331-6		Solder
✓ 595-521	1	Manual

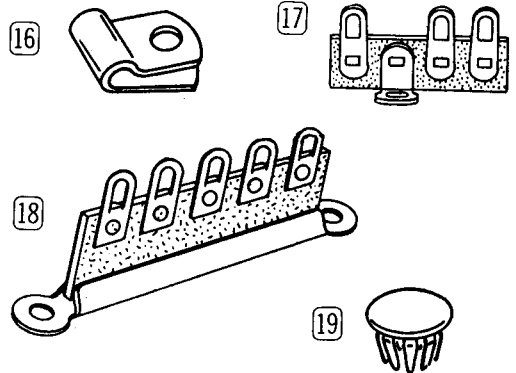

PROPER SOLDERING TECHNIQUES

Only a small percentage of HEATHKIT equipment purchasers find it necessary to return an instrument for factory service. Of these instruments, by far the largest portion of malfunctions are due to poor or improper soldering.

If terminals are bright and clean and free of wax,

frayed insulation and other foreign substances, no difficulty will be experienced in soldering. Correctly soldered connections are essential if the performance engineered into a kit is to be fully realized. If you are a beginner with no experience in soldering, a half hour's practice with some odd lengths of wire may be a worthwhile investment.

For most wiring, a 30 to 100 watt iron or its equivalent in a soldering gun is very satisfactory. A lower wattage iron than this may not heat the connection enough to flow the solder smoothly over the joint. Keep the iron tip clean and bright by wiping it from time to time with a cloth.

CHASSIS WIRING AND SOLDERING

1. Unless otherwise indicated, all wire used is the type with colored insulation (hookup wire); the size of the conductor is the same for all colors of hookup wires furnished with this kit. In preparing a length of hookup wire, 1/4" of insulation should be removed from each end unless directed otherwise in the construction step.
2. To avoid breaking internal connections when stripping insulation from the leads of transformers or similar components, care should be taken not to pull directly on the lead. Instead, hold the lead with pliers while it is being stripped.
3. Leads on resistors, capacitors and similar components are generally much longer than they need to be to make the required connections. In these cases, the leads should be cut to proper length before the part is added to the chassis. In general, the leads should be just long enough to reach their terminating points.
4. Wherever there is a possibility of bare leads shorting to other parts or to the chassis, the leads should be covered with insulating sleeving. Where the use of sleeving is specifically intended, the phrase "use sleeving" is included in the associated construction step. In any case where there is the pos-

sibility of an unintentional short circuit, sleeving should be used. Extra sleeving is provided for this purpose.

5. Crimp or bend the lead (or leads) around the terminal to form a good joint without relying on solder for physical strength. If the wire is too large to allow bending or if the step states that the wire is not to be crimped, position the wire so that a good solder connection can still be made.
6. Position the work, if possible, so that gravity will help to keep the solder where you want it.
7. Place a flat side of the soldering iron tip against the joint to be soldered until it is heated sufficiently to melt the solder.
8. Then place the solder against the heated terminal and it will immediately flow over the joint; use only enough solder to thoroughly wet the junction. It is usually not necessary to fill the entire hole in the terminal with solder.
9. Remove the solder and then the iron from the completed junction. Use care not to move the leads until the solder is solidified.

A poor or cold solder joint will usually look crystalline and have a grainy texture, or the solder will stand up in a blob and will not have adhered to the joint. Such joints should be reheated until the solder flows smoothly over the entire junction. In some cases, it may be necessary to add a little more solder to achieve a smooth bright appearance.

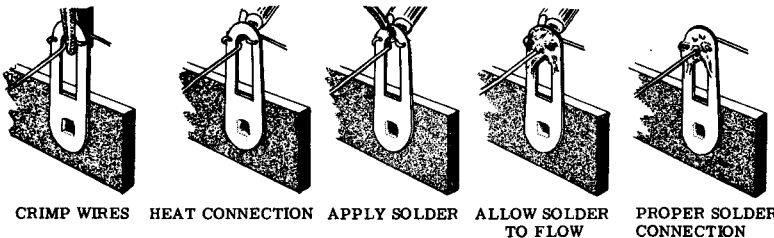

ROSIN CORE SOLDER HAS BEEN SUPPLIED WITH THIS KIT. THIS TYPE OF SOLDER MUST BE USED FOR ALL SOLDERING IN THIS KIT. ALL GUARANTEES ARE VOIDED AND WE WILL NOT REPAIR OR SERVICE EQUIPMENT IN WHICH ACID CORE SOLDER OR PASTE FLUXES HAVE BEEN USED. IF ADDITIONAL SOLDER IS NEEDED, BE SURE TO PURCHASE ROSIN CORE (60:40 or 50:50 TIN-LEAD CONTENT) RADIO TYPE SOLDER.

STEP-BY-STEP PROCEDURE

The following instructions are presented in a logical step-by-step sequence to enable you to complete your kit with the least possible confusion. Be sure to read each step all the way through before beginning the specified operation. Also read several steps ahead of the actual step being performed. This will familiarize you with the relationship of the subsequent operations. When the step is completed, check it off in the space provided. This is particularly important as it may prevent errors or omissions, especially if your work is interrupted. Some kit builders have also found it helpful to mark each lead in colored pencil on the Pictorial as it is added.

The fold-out diagrams in this manual may be removed and attached to the wall above your working area; but, because they are an integral part of the instructions, they should be returned to the manual after the kit is completed.

In general, the illustrations in this manual correspond to the actual configuration of the kit; however, in some instances the illustra-

tions may be slightly distorted to facilitate clearly showing all of the parts.

The abbreviation "NS" indicates that a connection should not be soldered yet as other wires will be added. When the last wire is installed, the terminal should be soldered and the abbreviation "S" is used to indicate this. Note that a number will appear after each solder instruction. This number indicates the number of leads that are supposed to be connected to the terminal in point before it is soldered. For example, if the instruction reads, "Connect a lead to lug 1 (S-2)," it will be understood that there will be two leads connected to the terminal at the time it is soldered. (In cases where a lead passes through a terminal or lug and then connects to another point, it will count as two leads, one entering and one leaving the terminal.)

The steps directing the installation of resistors include color codes to help identify the parts. Also, if a part is identified by a letter-number designation on the Schematic, its designation will appear at the beginning of the construction step which directs its installation.

STEP-BY-STEP ASSEMBLY

PARTS MOUNTING

Refer to Pictorial 1 (fold-out from Page 11) for the following steps.

- (1) Locate the three 11-lug miniature terminal strips and cut off the third lug from each end, according to Detail 1A.
- (2) Position the chassis as shown in Pictorial 1.
- (3) Refer to Detail 1A and mount one of these terminal strips at location F. Use a 3-48 x 1/4" screw, two #3 lockwashers, and a 3-48 nut at each mounting hole. Position as shown.
- (4) In a like manner, and using the same hardware, mount the two remaining miniature terminal strips at G and H. Position as shown.
- (5) Refer to Detail 1B and mount the 3-lug terminal strip at B. Use a 6-32 x 1/4" screw, two #6 lockwashers, and a 6-32 nut. Position as shown.

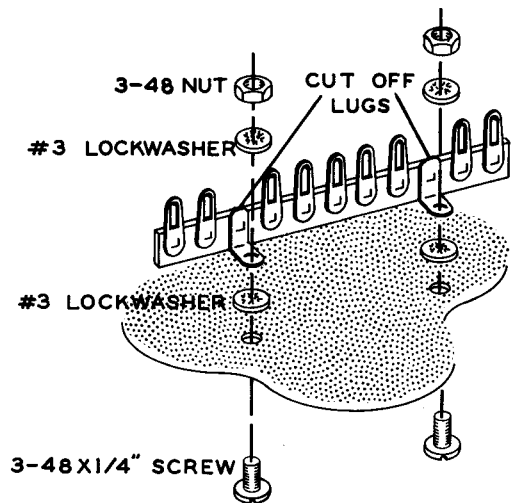

Detail 1A

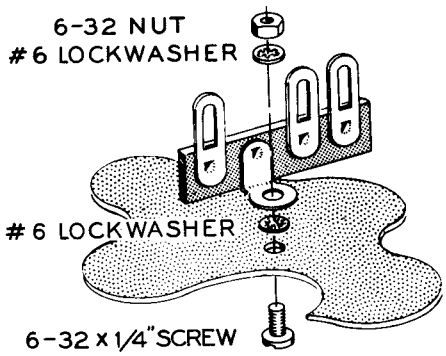

Detail 1B

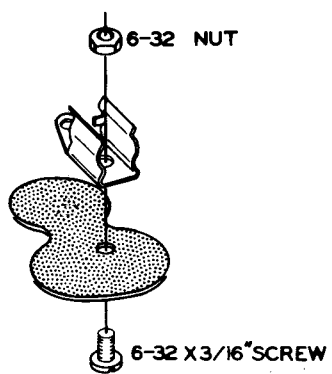

Detail 1D

(✓) Refer to Detail 1C and mount the 5-lug terminal strip at N. Use a 6-32 x 1/4" screw, a #6 lockwasher, and a 6-32 nut at each hole.

(✓) T2. Refer to Detail 1E and pass the red and blue leads of the output transformer down through chassis hole E from the top of the chassis. Secure the transformer in place at D with a 3-48 x 1/4" screw, a #3 lockwasher, and a 3-48 nut at each mounting hole.

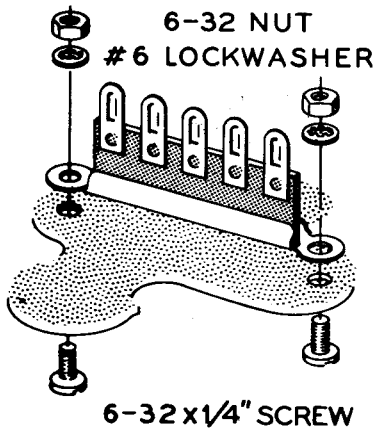

Detail 1C

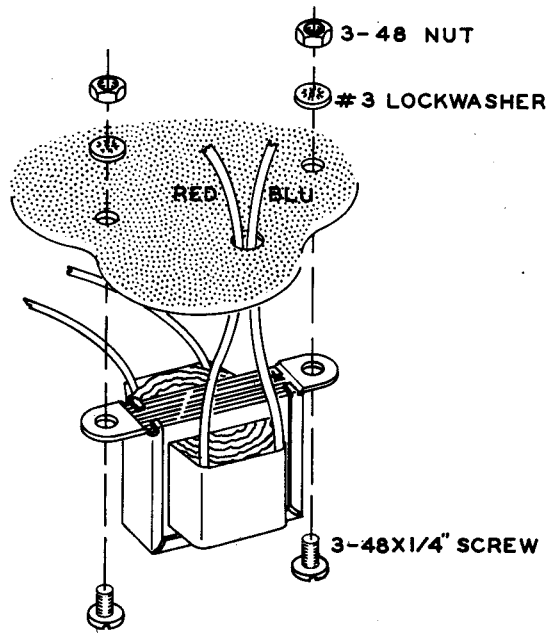

Detail 1E

(✓) Refer to Detail 1D and locate the transistor mounting clip. Mount the clip at C. Use a 6-32 x 3/16" screw and a 6-32 nut at the large hole.

(✓) Locate output transformer (#51-87). Cut the blue lead to 1-1/4" and the red lead to 1-1/2". Strip and tin the end of each lead. ("Tin" means to melt a small amount of solder on the exposed lead end.) Do not cut the other two leads.

- (✓) T1. Refer to Detail 1F and mount the inter-stage transformer (#52-51) at J. Position the color dot as shown.

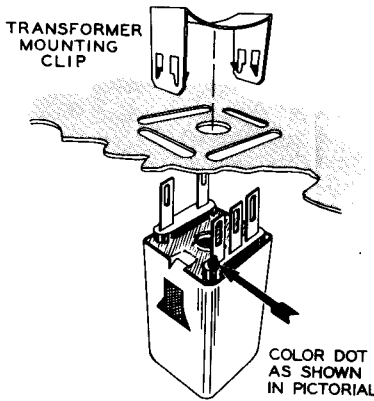

Detail 1F

- (✓) SW3. Mount the slide switch at L. Use 6-32 x 3/16" screws. The switch can be positioned either way.
- (✓) L2. Refer to Detail 1G and mount the oscillator coil (#40-435) at K. Position the mounting tab in the small slot. Do not push on the ferrite cup, as the coil may be damaged. Make sure the side tabs spring out to lock the coil in place.

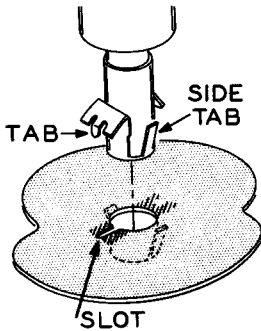

Detail 1G

- (✓) L1. In a like manner, mount the line input coil (#40-434) at M.
- (✓) Refer to Detail 1H and mount the 6-32 speednuts at the slotted holes of the speaker bracket.

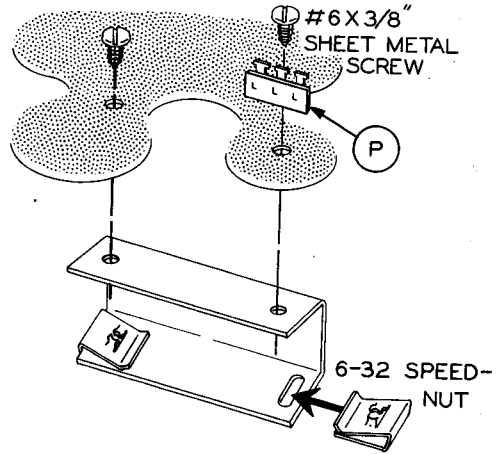

Detail 1H

- (✓) Mount the speaker bracket on top of the chassis and mount 3-lug miniature terminal strip P below the chassis. The open side of the bracket should be toward the interstage transformer at J. Use two #6 x 3/8" sheet metal screws.

PRELIMINARY CHASSIS WIRING

Cut the three colors of hookup wire to the following lengths. Strip 1/4" insulation from the ends of each wire. The wire lengths are listed in the order that they will be used in the following steps.

COLOR	LENGTH
(✓) Green	2-1/4"
(✓) Yellow	3-3/4"
(✓) Red	2"
(✓) Green	2"
(✓) Yellow	1-1/2"
(✓) Red	3-1/2"
(✓) Yellow	4-1/4"

CAUTION: It is very important that all wires be positioned exactly as shown in the Pictorials and Details to permit the addition of other parts later. ALL WIRES AND PARTS SHOWN IN DETAIL 2A, AND PICTORIALS 2 AND 3 WILL BE CONNECTED TO THE BOTTOM HOLES IN THE LUGS OF MINIATURE TERMINAL STRIPS F, G, H, AND P.

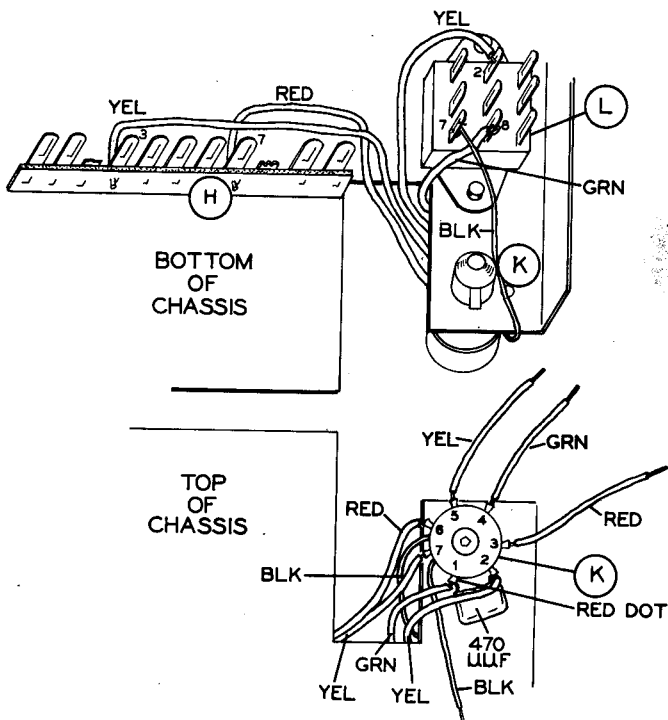

Detail 2A

Refer to Detail 2A for the following steps.

(4) Connect one of the black leads extending from the coil at K to lug 7 of switch L (NS).

NOTE: When wiring to coil K in the following steps, the lug marked with the red dot is number 1. The lugs are numbered counter-clockwise when viewed from the top of the chassis.

(4) Connect a 2-1/4" green wire from lug 1 of coil K (NS) to lug 8 of switch L (NS).

(4) Connect a 3-3/4" yellow wire from lug 2 of coil K (NS) to lug 2 of switch L (S-1).

(4) Connect one end of a 2" red wire to lug 3 of coil K (S-1). Leave the other end free to be connected later.

(4) Connect one end of a 2" green wire to lug 4 of coil K (S-1). Position the wire down through the chassis cutout and leave the other end free to be connected later.

(4) Connect one end of a 1-1/2" yellow wire to lug 5 of coil K (S-1). Leave the other end free to be connected later.

(4) Connect a 3-1/2" red wire from lug 6 of coil K (S-1) to lug 7 of terminal strip H (NS).

(4) Connect a 4-1/4" yellow wire from lug 7 of coil K (S-1) to lug 3 of terminal strip H (NS).

(4) C2. Connect a 470 μf silver mica capacitor between lug 1 (S-2) and lug 2 (S-2) of coil K.

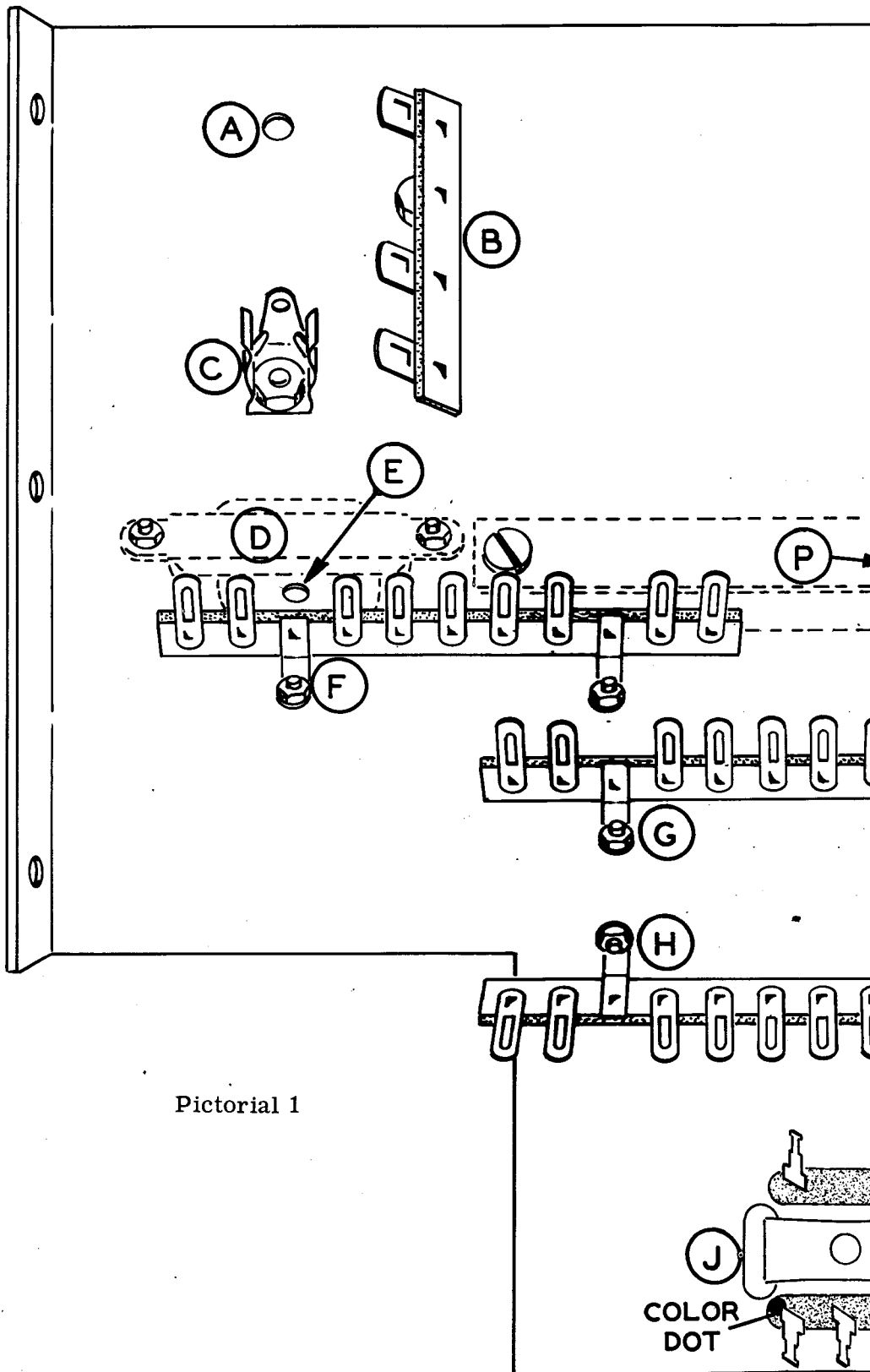

Pictorial 1

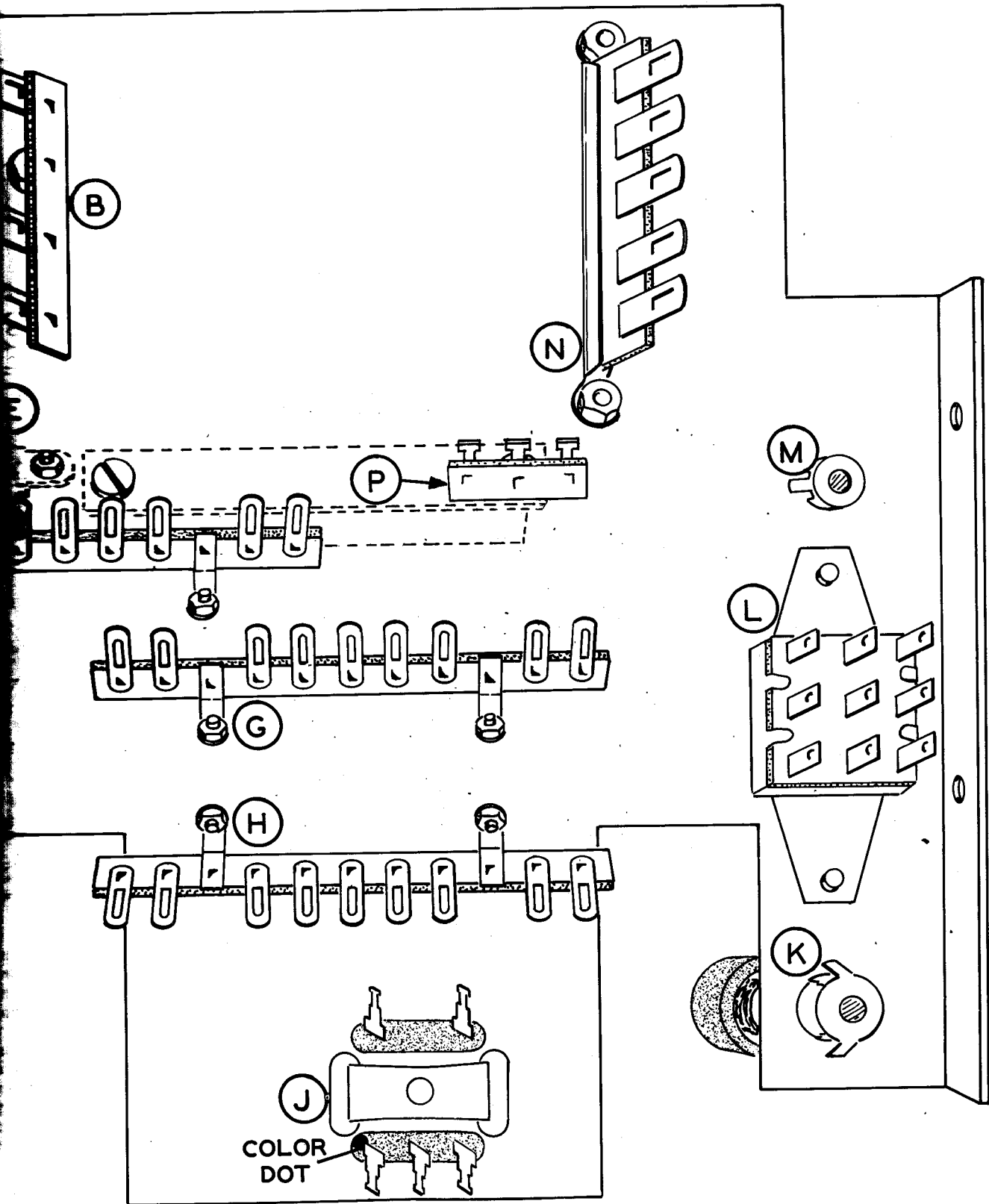

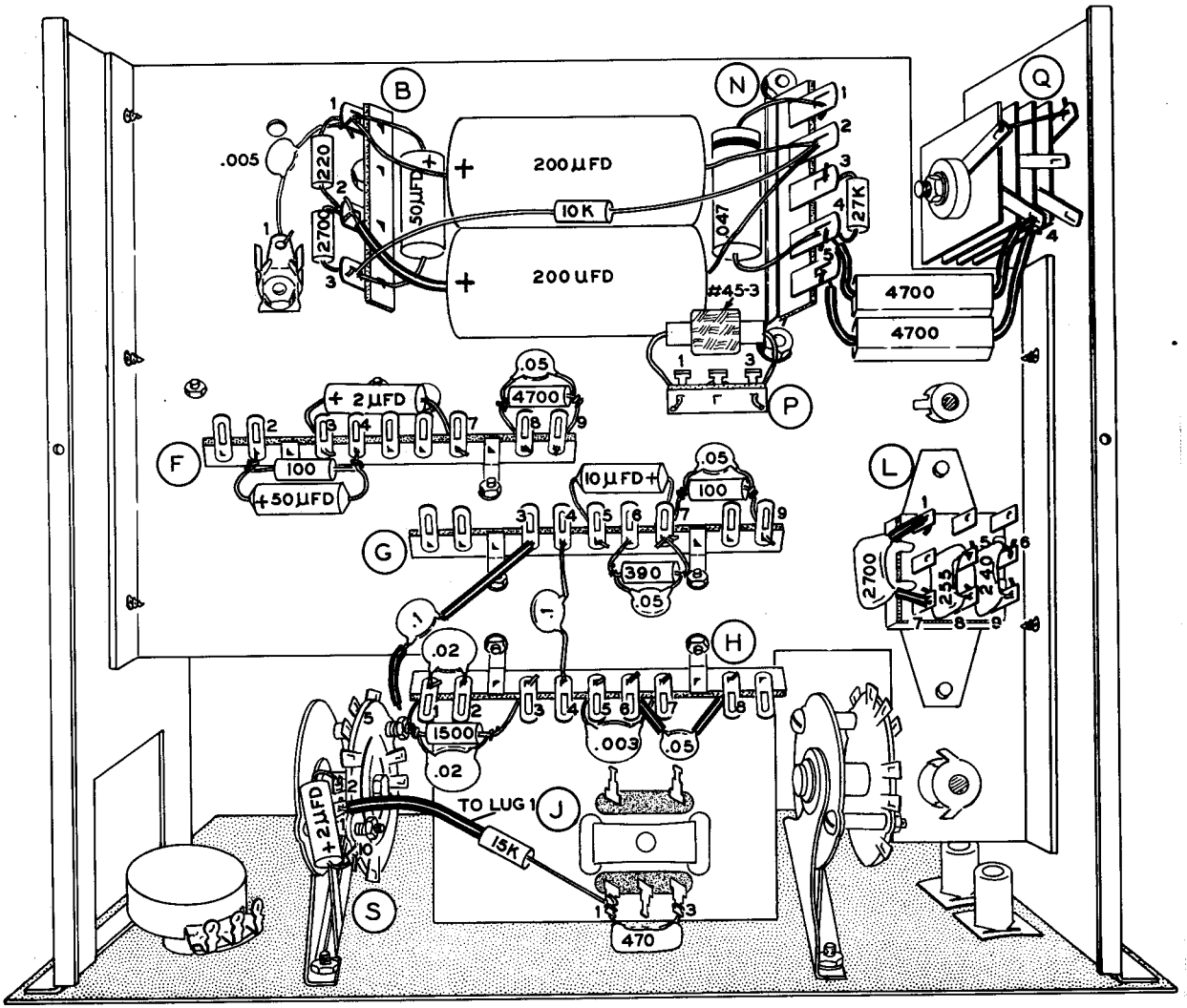

Pictorial 3

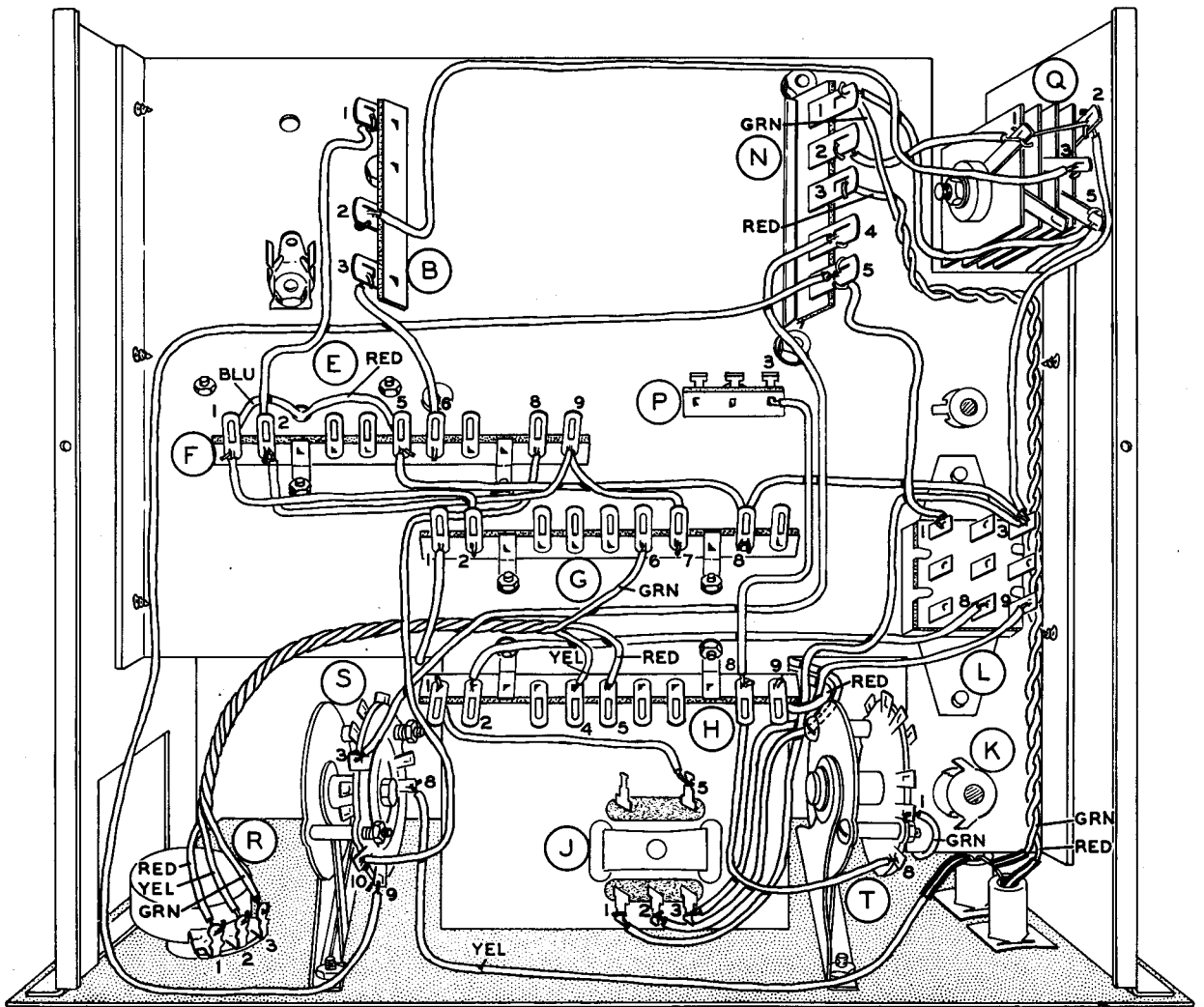

Pictorial 2

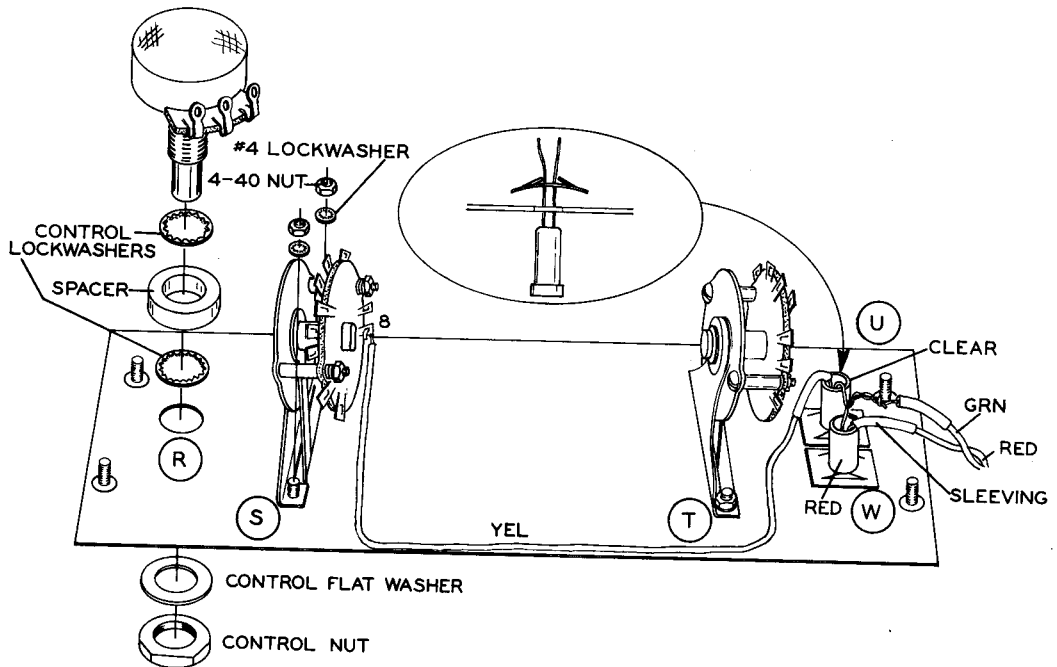

Detail 2B

Refer to Detail 2B for the following steps.

Cut the following lengths of hookup wire:

COLOR	LENGTH
(✓) Green	8-1/4"
(✓) Red	8-1/4"
(✓) Yellow	7"

- (✓) R11. Mount the Volume control (#10-119) at R. Use two control lockwashers, the spacer, a control flat washer, and a control nut. Position as shown.
- (✓) Twist together an 8-1/4" green and an 8-1/4" red wire.
- (✓) Place a 1/2" piece of sleeving over the end of each wire at one end of the twisted pair.
- (✓) Mount the red pilot lamp at position W on the front panel. Use a push-on speednut and position as shown.
- (✓) Cut one lead of the clear pilot lamp and one lead of the red pilot lamp to 3/4". Twist these leads together.
- (✓) In a like manner, mount the clear pilot lamp at U.
- (✓) Wrap the bare end of the green wire of the twisted pair, with sleeving on it, around the twisted leads of the pilot lamps. Solder this connection and push the sleeving over the connection.
- (✓) SW2. Mount the spring return lever switch (#62-19) at S. Use a #4 lockwasher and a 4-40 nut on each mounting stud. Position as shown.
- (✓) At the same end of the twisted wires, twist the free lead of the red pilot lamp around the end of the red lead. Solder this connection and push the sleeving over the connection.
- (✓) SW1. In a like manner, mount a lever switch (#62-20) at T.
- (✓) Make the connection as close to the pilot lamp as possible.

(✓) Connect one end of a 7" yellow wire to the free lead of the clear pilot lamp. Solder the connection and slip a 1/2" piece of sleeving over the connection. Again make the connection as close to the pilot lamp as possible.

(✓) Position the yellow wire as shown and connect the free end to lug 8 of switch S (NS).

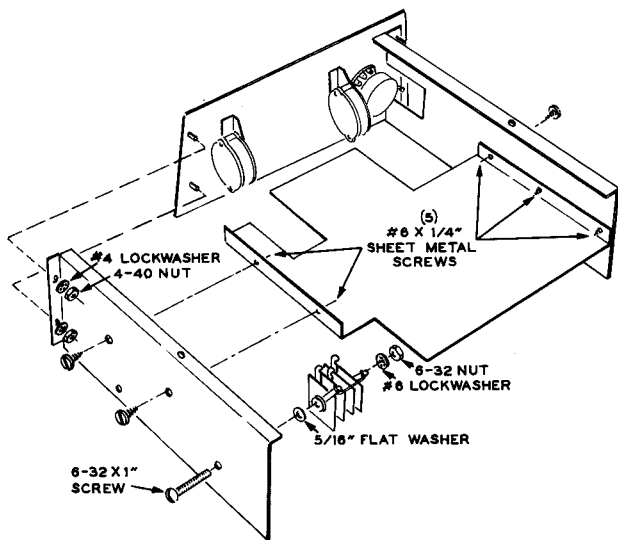

Detail 2C

Refer to Detail 2C for the following steps.

(✓) Mount the metal rectifier at Q on the end bracket. Use a 6-32 x 1" screw, a 5/16" flat washer, a #6 lockwasher, and a 6-32 nut. Position as shown. Also see Pictorial 2 for proper positioning.

(✓) Mount this end bracket to the chassis. Use two #6 x 1/4" sheet metal screws. Do not tighten.

(✓) Mount the other end bracket to the chassis. Use three #6 x 1/4" sheet metal screws. Do not tighten.

(✓) Fit the four studs of the front panel into the holes of the end brackets, and secure with a #4 lockwasher and 4-40 nut on each stud.

(✓) Now tighten the five sheet metal screws holding the end brackets to the chassis.

UNDERCHASSIS WIRING

Refer to Pictorial 2 for the following steps.

Cut the following lengths of hookup wire.

COLOR	LENGTH
(✓) Red	5"
(✓) Yellow	4-3/4"
(✓) Green	5-3/4"

CAUTION: Be careful not to flow too much solder onto the connections of the lever switches, as it may run into the switch contacts and ruin the switch.

(✓) Connect the free end of the green wire from lug 4 of coil K to lug 1 of switch T (S-1).

(✓) Position the red and green twisted pair from the pilot lamps as shown. Connect the green wire to lug 1 (NS) and the red wire to lug 3 (NS) of terminal strip N.

(✓) Connect the blue transformer lead extending from chassis hole E to lug 1 of terminal strip F (NS).

(✓) Connect the red transformer lead extending from chassis hole E to lug 5 of terminal strip F (NS).

(✓) Twist together a 5" red wire and a 4-3/4" yellow wire. Now twist a 5-3/4" green wire around the red and yellow twisted pair.

At the end of the three twisted wires where the ends are even, connect the wires to control R as follows:

(✓) Green to lug 3 (S-1).

(✓) Yellow to lug 2 (S-1).

(✓) Red to lug 1 (S-1).

At the other end of the three twisted wires, make the following connections:

(✓) Yellow to lug 4 of terminal strip H (NS).

- ~~(✓)~~ Red to lug 5 of terminal strip H (NS).
~~(✓)~~ Green to lug 6 of terminal strip G (NS).

NOTE: In the following steps, use green hookup wire cut to the following lengths.

- ~~(✓)~~ 7-1/4"
~~(✓)~~ 10"
~~(✓)~~ 5"
~~(✓)~~ 12"
~~(✓)~~ 3-1/4"
~~(✓)~~ 4-3/4"
~~(✓)~~ 6-3/4"
~~(✓)~~ 4"
~~(✓)~~ 5"

Cut the following lengths of green hookup wire.

- ~~(✓)~~ 2-1/2"
~~(✓)~~ 3-1/2"
~~(✓)~~ 3-1/4"
~~(✓)~~ 3-1/2"
~~(✓)~~ 2"
~~(✓)~~ 3"
~~(✓)~~ 2-3/4"
~~(✓)~~ 2"
~~(✓)~~ 4-1/2"
~~(✓)~~ 3-3/4"
~~(✓)~~ 4-1/4"
~~(✓)~~ 3"
~~(✓)~~ 2-1/2"
~~(✓)~~ 6-1/4"
~~(✓)~~ 2-1/2"

- ~~(✓)~~ Connect a 7-1/4" wire from lug 3 of switch S (S-1) to lug 4 of terminal strip N (NS). Position the wire as shown.
- ~~(✓)~~ Connect one end of a 10" wire to lug 1 of terminal strip G (S-1). Pass the free end of this wire down through the cutout behind switch S for connection later.
- ~~(✓)~~ Connect a 5" wire from lug 10 of switch S (NS) to lug 8 of terminal strip F (NS).
- ~~(✓)~~ Connect a 12" wire from lug 9 of switch S (S-1) to lug 5 of terminal strip N (NS).
- ~~(✓)~~ Connect a 3-1/4" wire from lug 1 of terminal strip H (NS) to lug 5 of transformer J (NS).
- ~~(✓)~~ Connect a 4-3/4" wire from lug 2 of terminal strip H (NS) to lug 8 of switch L (NS).
- ~~(✓)~~ Connect a 6-3/4" wire from lug 1 of transformer J (NS) to lug 3 of switch L (NS).
- ~~(✓)~~ Connect one end of a 4" wire to lug 2 of transformer J (S-1). Pass the free end down through the rear of the cutout next to switch T for connection later.
- ~~(✓)~~ Connect a 5" wire from lug 3 of transformer J (NS) to lug 9 of switch L (NS).
- ~~(✓)~~ Cut a 3" length of red hookup wire and connect one end to lug 9 of terminal strip H (S-1). Pass the free end down through the chassis cutout next to switch T for connection later.
- ~~(✓)~~ Connect a 2-1/2" wire from lug 8 of terminal strip H (NS) to lug 8 of switch T (S-1).
- ~~(✓)~~ Connect a 3-1/2" wire from lug 8 of terminal strip H (NS) to lug 3 of terminal strip P (NS).
- ~~(✓)~~ Connect a 3-1/4" wire from lug 8 of terminal strip G (NS) to lug 3 of switch L (NS).
- ~~(✓)~~ Connect a 3-1/2" wire from lug 8 of terminal strip G (S-2) to lug 5 of terminal strip F (S-2).
- ~~(✓)~~ Connect a 2" wire from lug 7 of terminal strip G (NS) to lug 9 of terminal strip F (NS).
- ~~(✓)~~ Connect a 3" wire between lug 2 (NS) and lug 9 (NS) of terminal strip F.
- ~~(✓)~~ Connect a 2-3/4" wire from lug 1 of terminal strip F (S-2) to lug 2 of terminal strip G (S-1).
- ~~(✓)~~ Connect a 2" wire from lug 6 of terminal strip F (S-1) to lug 3 of terminal strip B (NS).
- ~~(✓)~~ Connect a 4-1/2" wire from lug 2 of terminal strip F (NS) to lug 1 of terminal strip B (NS).
- ~~(✓)~~ Connect a 3-3/4" wire from lug 1 of switch L (NS) to lug 5 of terminal strip N (NS).

NOTE: There is already a jumper wire connected between lugs 1 and 2 of rectifier Q. This will count as one connection at each of these lugs.

- ~~(✓)~~ Connect a 4-1/4" wire from lug 3 of switch L (S-3) to lug 2 of rectifier Q (S-2).

- ✓ (1) Connect a 3" wire from lug 5 of rectifier Q (NS) to lug 1 of terminal strip N (NS).
- ✓ (2) Connect one end of a 2-1/2" wire to lug 5 of rectifier Q (S-2). Pass the free end of the wire down through the chassis cutout near rectifier Q for connection later.
- ✓ (3) Connect a 6-1/4" wire from lug 3 of rectifier Q (S-1) to lug 2 of terminal strip B (NS).
- ✓ (4) Connect the 2-1/2" wire from lug 1 of rectifier Q (S-2) to lug 2 of terminal strip N (NS).

This completes the underchassis wiring. Carefully check to see that no steps have been missed and that all wires are placed as shown.

COMPONENT INSTALLATION

NOTE: Component leads are usually longer than necessary. Therefore, the component being installed should be placed in the position shown in the Pictorial and connected as directed, then the excess leads clipped off.

When installing capacitors, be sure the marked ends (positive (+) for electrolytics and color band or shoulder for tubular type, disc ceramic capacitors may be installed either way) are installed as shown to insure proper operation of the completed kit.

THE COMPONENTS INSTALLED IN THE FOLLOWING STEPS WILL BE CONNECTED TO THE LOWER HOLES IN THE MINIATURE TERMINAL STRIPS.

Refer to Pictorial 3 (fold-out from Page 12) for the following steps.

- ✓ (1) C15. Connect a 2 μ fd electrolytic capacitor between lug 2 (NS) and lug 10 (S-2) of switch S.
- ✓ (2) Refer to Detail 3A and make a resistor-capacitor combination, using a 50 μ fd electrolytic capacitor and a 100 Ω (brown-black-brown) 1/2 watt resistor.

Detail 3A

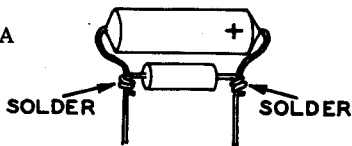

- ✓ (3) C19, R17. Connect this combination between lug 2 (S-3) and lug 4 (S-1) of terminal strip F. Position as shown.

- ✓ (4) C18. Connect a 2 μ fd electrolytic capacitor between lug 3 (S-1) and lug 7 (S-1) of terminal strip F.

- ✓ (5) Refer to Detail 3B and make a resistor-capacitor combination, using a 4700 Ω (yellow-violet-red) 1/2 watt resistor and a .05 μ fd disc capacitor.

Detail 3B

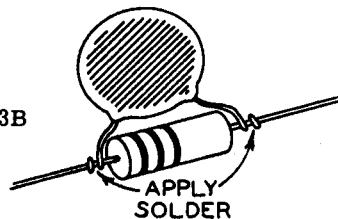

- ✓ (1) C17, R15. Connect this combination between lug 8 (S-2) and lug 9 (S-3) of terminal strip F. Make sure the leads do not touch the chassis.

- ✓ (2) C13. Connect a 10 μ fd electrolytic capacitor between lug 5 (S-1) and lug 7 (NS) of terminal strip G.

- ✓ (3) Make a resistor-capacitor combination with a 100 Ω (brown-black-brown) 1/2 watt resistor and a .05 μ fd disc capacitor.

- ✓ (4) C8, R6. Connect this combination between lug 7 (NS) and lug 9 (S-1) of terminal strip G.

- ✓ (5) Make another combination with a 390 Ω (orange-white-brown) 1/2 watt resistor and a .05 μ fd disc capacitor.

- ✓ (6) C14, R12. Connect this combination between lug 6 (S-2) and lug 7 (S-4) of terminal strip G.

- ✓ (7) C7. Connect a .02 μ fd disc capacitor between lug 1 (NS) and lug 2 (S-2) of terminal strip H.

- ✓ (8) C20. Cut one lead of a .1 μ fd disc capacitor to 1-1/4". Place a 1" length of sleeving over this lead and connect it to lug 3 of terminal strip G (S-1). Pass the other lead down through the chassis cutout behind switch S for connection later.

- (✓) Make a combination, using a 1500 Ω (brown-green-red) 1/2 watt resistor and a .02 μfd disc capacitor.
- (✓) C5, R2. Connect this combination between lug 1 (S-3) and lug 3 (S-2) of terminal strip H.
- (✓) C12. Connect a .003 μfd disc capacitor between lug 5 (S-2) and lug 7 (S-2) of terminal strip H.
- (✓) C16. Connect a .1 μfd disc capacitor from lug 4 of terminal strip H (S-2) to lug 4 of terminal strip G (S-1).
- (✓) C6. Place a 1/4" piece of sleeving on each lead of a .05 μfd disc capacitor and connect it between lug 6 (S-1) and lug 8 (S-3) of terminal strip H.
- (✓) R8. Connect a 15 K Ω (brown-green-orange) 1/2 watt resistor from lug 1 of switch S (NS) to lug 1 of transformer J (NS). Use sleeving on the lead to the switch.
- (✓) C11. Connect a 470 μmf silver mica capacitor between lug 1 (S-3) and lug 3 (S-2) of transformer J.
- (✓) C10. Connect a 240 μmf silver mica capacitor between lug 6 (S-1) and lug 9 (S-2) of switch L. Position the body of the capacitor as shown.
- (✓) C1. Connect a 255 μmf silver mica capacitor between lug 5 (S-1) and lug 8 (S-3) of switch L.
- (✓) C4. Connect a 2700 μmf silver mica capacitor between lug 1 (S-2) and lug 7 (NS) of switch L. Use sleeving on both leads.
- (✓) L4. Connect an RF choke (#45-3) between lugs 1 (S-1) and 3 (S-2) of terminal strip P. Be careful when bending the leads not to break the fine coil wire near the end of the coil form.
- (✓) C21. Connect a .047 μfd tubular capacitor between lug 1 (NS) and lug 4 (NS) of terminal strip N.
- (✓) C23. Connect a 50 μfd electrolytic capacitor between lug 1 (NS) and lug 3 (NS) of terminal strip B.
- (✓) C24. Connect a 200 μfd electrolytic capacitor from lug 1 of terminal strip B (NS) to lug 2 of terminal strip N (NS). Position exactly as shown.
- (✓) C22. Connect a 200 μfd electrolytic capacitor from lug 2 of terminal strip B (NS) to lug 2 of terminal strip N (NS). Use sleeving on the lead to terminal strip B.

NOTE: Position the body of the 7 watt resistors so that the rough (filled) side is up away from the chassis.

(✓) R23. Connect a 4700 Ω 7 watt resistor from lug 4 of rectifier Q (NS) to lug 4 of terminal strip N (NS). Use sleeving on both leads.

(✓) R22. Connect another 4700 Ω 7 watt resistor from lug 4 of rectifier Q (S-2) to lug 5 of terminal strip N (NS). Use sleeving on both leads.

(✓) R24. Connect a 27 K Ω (red-violet-orange) 1/2 watt resistor between lug 3 (S-2) and lug 4 (S-4) of terminal strip N.

(✓) R27. Connect a 10 K Ω (brown-black-orange) 1/2 watt resistor from lug 2 of terminal strip N (S-4) to lug 3 of terminal strip B (NS).

(✓) R25. Connect a 2700 Ω (red-violet-red) 1/2 watt resistor between lug 2 (NS) and lug 3 (S-4) of terminal strip B.

(✓) R26. Connect a 220 Ω (red-red-brown) 1/2 watt resistor between lug 1 (NS) and lug 2 (S-4) of terminal strip B.

(✓) C25. Connect a .005 μfd disc capacitor between lug 1 of terminal strip B (S-5) and lug 1 of transistor clip C (S-1).

Refer to Pictorial 4 (fold-out from Page 19) for the following steps.

NOTE: IN THE FOLLOWING STEPS, ALL COMPONENTS WILL BE CONNECTED TO THE TOP HOLES OF THE MINIATURE TERMINAL STRIPS. NOTE THAT ALL THE BOTTOM HOLES OF THESE TERMINAL STRIPS ARE SOLDERED.

(✓) R7. Connect a 3300 Ω (orange-orange-red) 1/2 watt resistor from lug 1 of switch S (S-2) to lug 1 of terminal strip H (S-1).

- ✓ R1. Connect a 10 K Ω (brown-black-orange) 1/2 watt resistor between lug 2 (NS) and lug 3 (S-1) of terminal strip H.
- ✓ L3. Connect an RF choke (#45-3) from lug 2 of terminal strip H (S-2) to lug 2 of terminal strip G (NS). Be careful when bending the leads not to break the fine coil wire near the end of the coil form.
- ✓ R9. Connect a 15 K Ω (brown-green-orange) 1/2 watt resistor from lug 5 of terminal strip H (NS) to lug 5 of terminal strip G (NS).
- ✓ R5. Connect a 33 K Ω (orange-orange-orange) 1/2 watt resistor from lug 8 of terminal strip H (S-2) to lug 8 of terminal strip G (S-1).
- ✓ C3. Connect a 1300 μ f silver mica capacitor between lug 4 (S-1) and lug 7 (S-3) of switch L.
- ✓ R20. Connect a 330 Ω (orange-orange-brown) 1/2 watt resistor from lug 1 of terminal strip G (NS) to lug 6 of terminal strip F (S-1).
- ✓ C9. Connect a .02 μ f disc capacitor from lug 2 of terminal strip G (S-2) to lug 9 of terminal strip F (NS).
- ✓ R10. Connect a 2200 Ω (red-red-red) 1/2 watt resistor between lug 3 (NS) and lug 5 (S-2) of terminal strip G.
- ✓ R14. Connect a 56 K Ω (green-blue-orange) 1/2 watt resistor between lug 7 (NS) and lug 8 (NS) of terminal strip F.
- ✓ R13. Connect a 3300 Ω (orange-orange-red) 1/2 watt resistor from lug 4 of terminal strip G (S-1) to lug 8 of terminal strip F (NS).
- ✓ R18. Connect a 1000 Ω (brown-black-red) 1/2 watt resistor between lug 2 (S-1) and lug 3 (NS) of terminal strip F.
- ✓ R19. Connect a 5600 Ω (green-blue-red) 1/2 watt resistor between lug 3 (NS) and lug 5 (NS) of terminal strip F.
- ✓ R16. Connect a 3300 Ω (orange-orange-red) 1/2 watt resistor between lug 5 (S-2) and lug 7 (NS) of terminal strip F.
- ✓ D2. Connect the color-band end of a crystal diode to lug 5 of terminal strip H (S-2) and the other lead to lug 4 of transformer J (S-1).
- ✓ R3. Place a 1" piece of sleeving on a lead of a 1000 Ω (brown-black-red) 1/2 watt resistor. Connect this lead to lug 6 of terminal strip H (S-1). Connect the other lead to lug 3 of switch T (S-1). Use sleeving.
- ✓ D1. Slip a 1/2" length of sleeving over each lead of a crystal diode. Connect the lead at the color band end of this diode to lug 1 of terminal strip P (NS) and the other lead to lug 6 of terminal strip G (S-1).
- ✓ C27. Connect a .02 μ f disc capacitor from lug 7 of terminal strip G (NS) to lug 1 of terminal strip P (S-2).
- ✓ C26. Connect a .005 μ f disc capacitor between lugs 2 (S-1) and 3 (S-1) of terminal strip P.

NOTE: In cases where a lead passes through a lug and then connects to another point, it will count as two leads, one entering and one leaving the lug.

- ✓ R4. Pass one lead of a 2200 Ω (red-red-red) 1/2 watt resistor through lug 7 of terminal strip H (NS) to lug 5 of transformer J (S-2). Connect the other lead to lug 8 of terminal strip H (NS).
- ✓ Connect a piece of bare wire (lead clipping from a resistor) from lug 7 of terminal strip H (S-3) to lug 7 of terminal strip G (S-2).

Refer to the Transistor Location Chart and find the column which corresponds to the transistor bag marking (A through D) which corresponds to the marking on the transistor bag received in this kit. Mark out the other columns. The colors listed in the proper column should correspond to the color dot on the tops of the transistors.

TRANSISTOR LOCATION CHART				
LOCATION	BAG A	BAG B	BAG C	BAG D
X1	RED	ORANGE	ORANGE	YELLOW
X2	VIOLET	BLUE	GREEN	YELLOW
X3	BROWN	RED	RED	ORANGE
X4	VIOLET	BLUE	GREEN	YELLOW

BOTTOM VIEW OF TRANSISTOR	
LOCATING TAB	EMITTER LEAD BASE LEAD COLLECTOR LEAD



- (✓) Locate the correct transistor, by the color dot, for transistor X1. Cut the leads to the following lengths and place 1" of sleeving on the base lead.

Emitter - 3/4"
Base - do not cut
Collector - 3/4"

X1. Position the transistor with its top, flat on the chassis as shown and connect the leads as follows:

- (✓) Emitter to lug 9 of terminal strip G (S-1).
(✓) Base to lug 2 of switch T (S-1).
(✓) Collector to lug 9 of terminal strip H (S-1).

- (✓) Cut the leads of the transistor for position X2 as follows, and place sleeving on the base and collector leads.

Emitter - 7/8"
Base - do not cut.
Collector - 1-1/4"

X2. Position the transistor on the chassis as before and connect the leads as follows:

- (✓) Emitter to lug 1 of terminal strip G (S-2).
(✓) Base to lug 3 of terminal strip G (S-2).
(✓) Collector to lug 2 of switch S (S-2).

- (✓) Cut the leads of the transistor for position X3 as follows:

Emitter - 1-1/8"
Base - 1"
Collector - 1"

X3. Position the transistor as before and connect the leads as follows:

- (✓) Emitter to lug 9 of terminal strip F (S-2).
(✓) Base to lug 8 of terminal strip F (S-3).
(✓) Collector to lug 7 of terminal strip F (S-3).

Make sure the transistor leads are separated and do not touch any other component, or the transistor case.

X4. Snap the remaining transistor into the transistor clip at C, and connect the leads as follows. Do not cut the leads.

- (✓) Emitter to lug 4 of terminal strip F (S-1).
(✓) Base to lug 3 of terminal strip F (S-3).
(✓) Collector to lug 1 of terminal strip F (S-1).

This completes the underchassis wiring, except for the line cord. All connections should be soldered except lugs 1 and 5 of terminal strip N. The top hole in lug 4 of terminal strip H is not used. Shake out all wire clippings and solder splashings.

Refer to Pictorial 5 for the following steps.

- (✓) Position the chassis as shown.

- (✓) R21. Connect a 100-KΩ (brown-black-yellow) 1/2 watt resistor between lug 7 (S-1) and lug 8 (S-2) of switch S.

- (✓) Place sleeving on the lead of the .1 μfd disc capacitor extending up through the chassis cutout near switch S from lug 3 of terminal strip G. Connect this lead to lug 5 of switch S (S-1).

- (✓) Cut the green lead of transformer D to 3-1/4", strip, and tin. Connect this lead to lug 4 of switch S (S-1).

- (✓) Twist together the long green wire, extending from the cutout behind switch S from lug 1 of terminal strip G, and the black lead of transformer D. Twist and solder the ends of these leads together.

- (✓) Connect one end of a 9" green wire to lug 6 of switch S (S-1). Leave the other end free to be connected later.

Connect the wires from coil K as follows:

- (✓) Black wire to lug 1 of coil M (S-1).

- (✓) Red wire from lug 3 to lug 5 of switch T (S-1).

- (✓) Yellow wire from lug 5 to lug 7 of switch T (S-1).

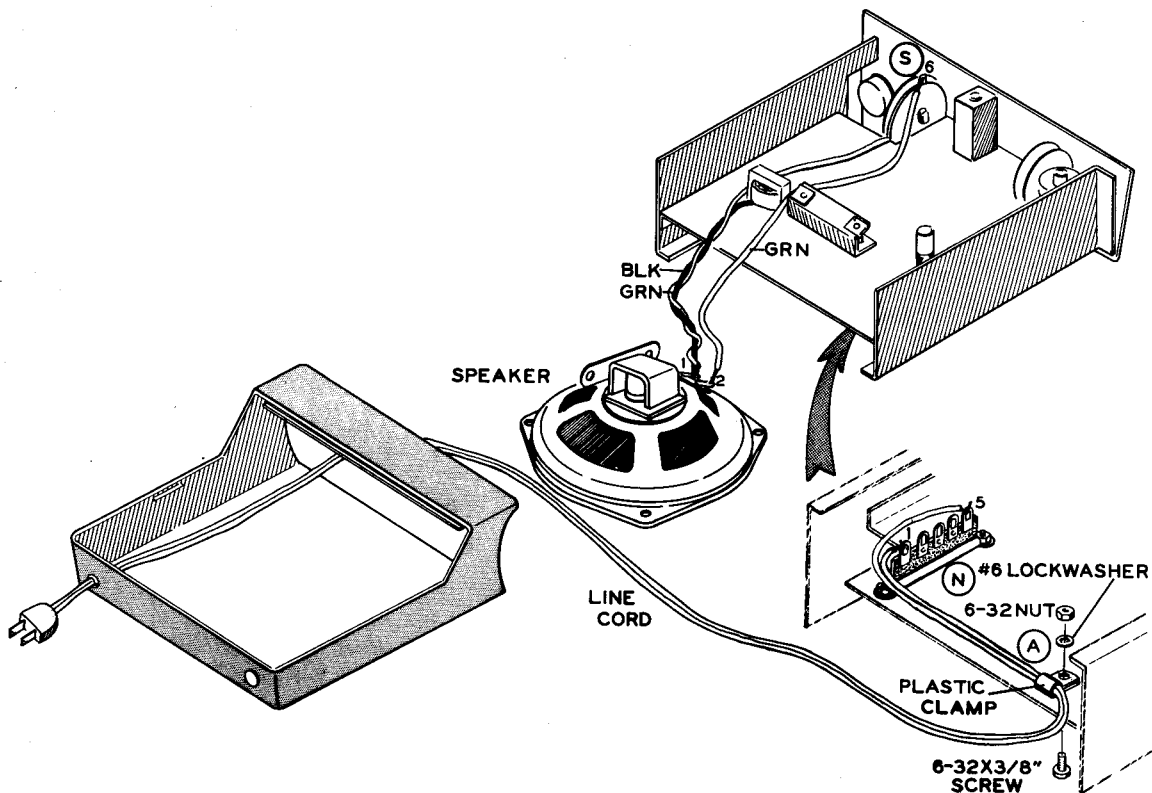

Detail 5A

Connect the wires extending from the chassis cutout next to switch T as follows:

- ✓ (1) Green wire from lug 2 of transformer J to lug 4 of switch T (S-1).
- ✓ (2) Red wire from lug 9 of terminal strip H to lug 6 of switch T (S-1).
- ✓ (3) Connect the wire from lug 5 of rectifier Q to lug 3 of coil M (S-1).

Refer to Detail 5A for the following steps.

- ✓ (4) Install the rubber grommet in the small hole in the rear of the cabinet base.
- ✓ (5) Tin the exposed leads of the line cord and pass the lead end through the rubber grommet of the cabinet base from the outside straight through, and out the front opening. Connect one lead to lug 1 (S-4) and the other lead to lug 5 (S-4) of terminal strip N.

- ✓ (6) Place the line cord as shown, and slip the plastic cable clamp over the cord. Secure the clamp to the chassis at position A with a 6-32 x 3/8" screw, #6 lockwasher, and 6-32 nut.
- ✓ (7) Carefully remove the speaker from its box, and lay it face down on your work area.
- ✓ (8) Connect the twisted pair of wires, the green hookup wire and the black transformer lead to lug 1 of the speaker (S-2).
- ✓ (9) Connect the free end of the wire from lug 6 of switch S to lug 2 of the speaker (S-1).
- ✓ (10) Install the bar knob on the levers of switches S and T.
- ✓ (11) Install the round knob on the Volume control shaft and tighten the setscrew. The control shaft should be fully counterclockwise and the pointer of the knob should be near the 7 o'clock position.

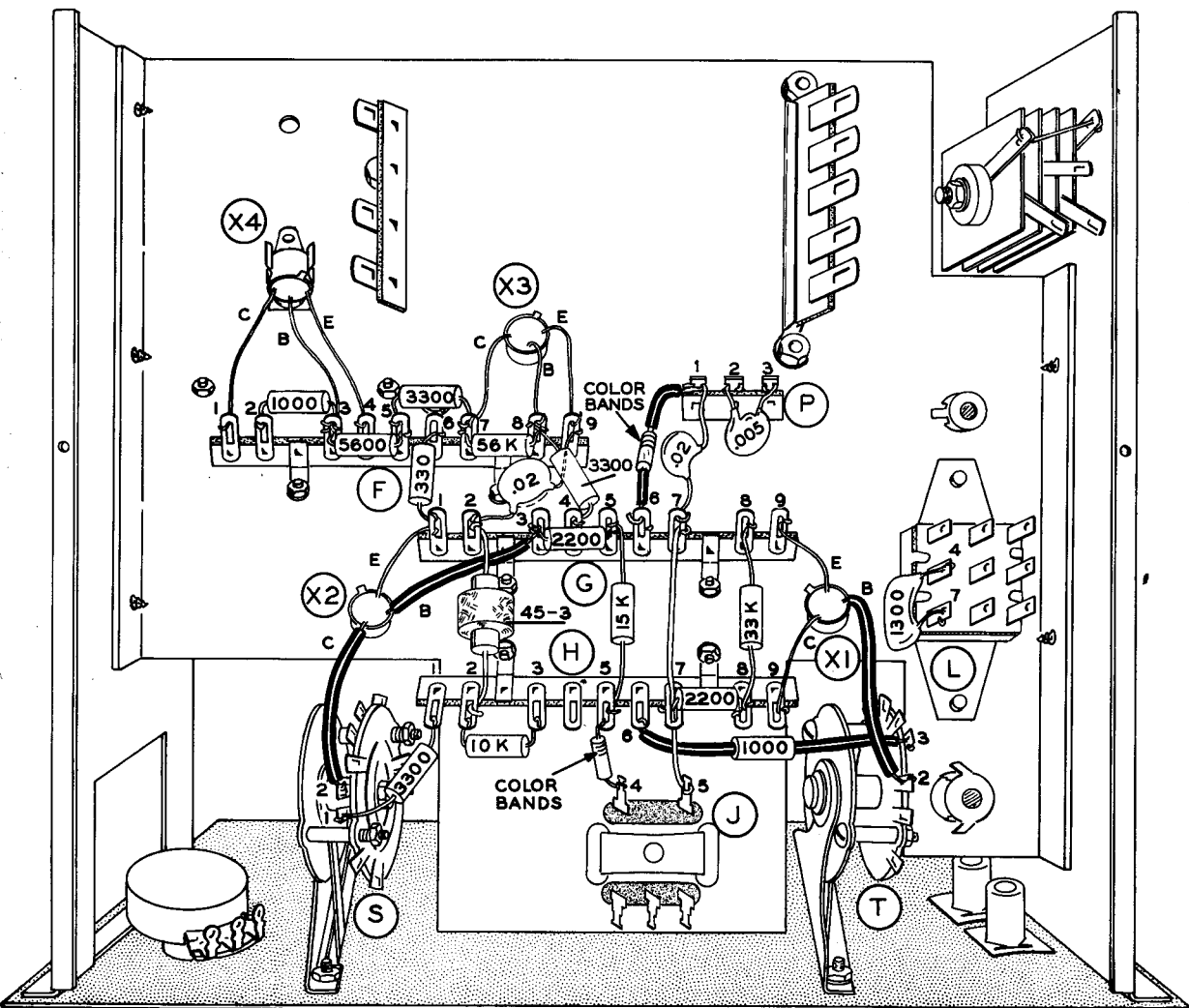

Pictorial 4

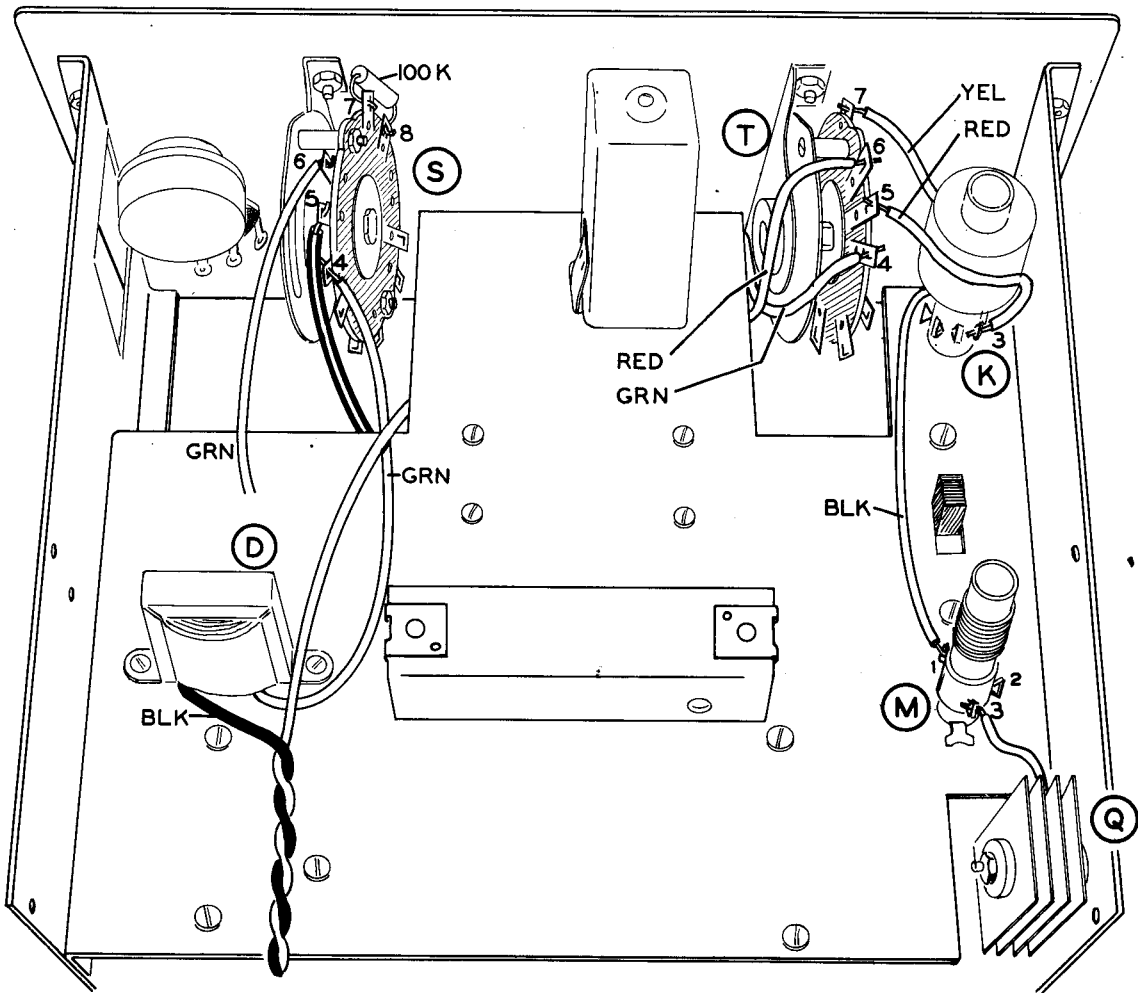

Pictorial 5

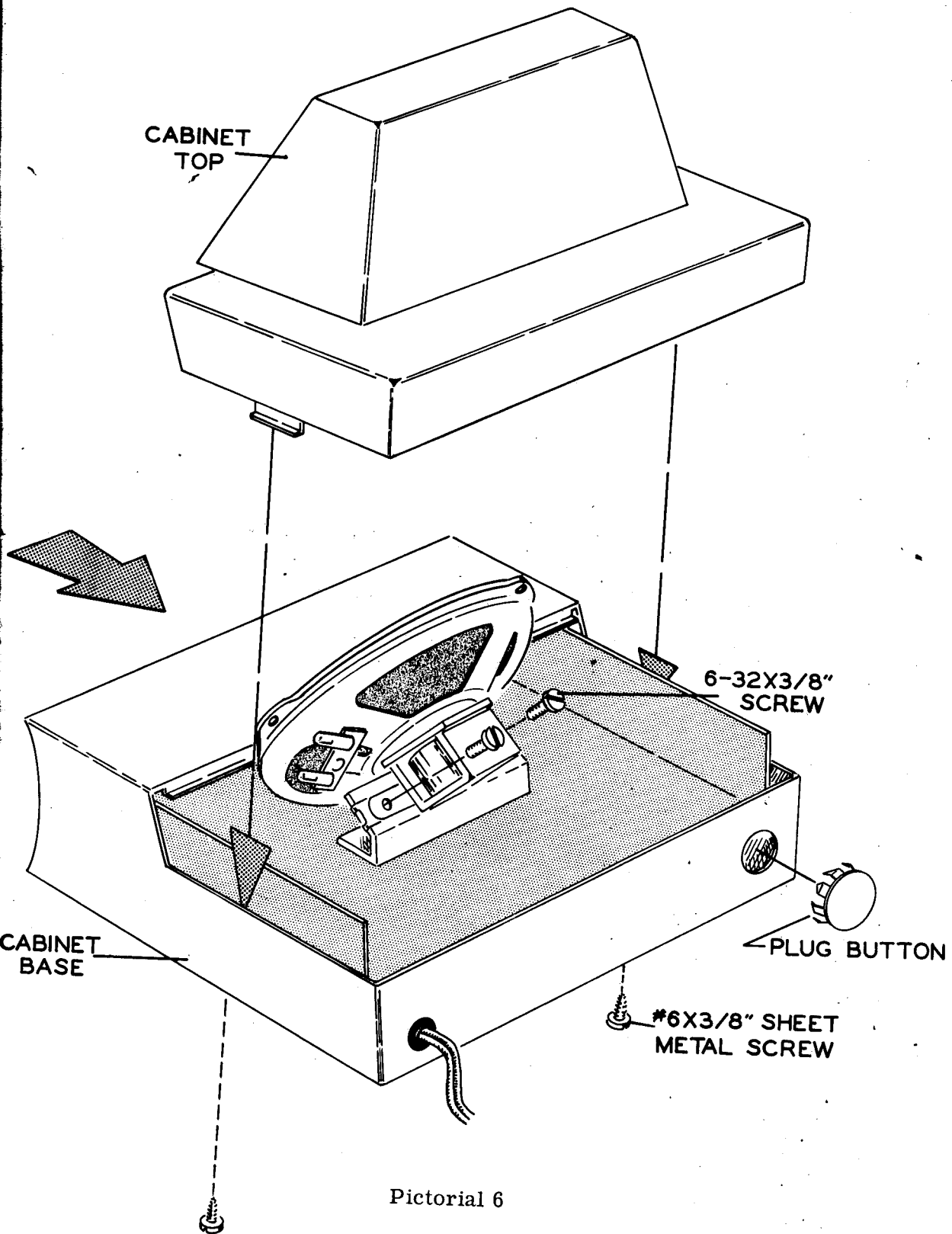

INITIAL TEST

Two Intercom stations are needed to perform the following tests. At least two Intercom kits should be completed at this time. Additional Intercom stations can be completed later.

NOTE: If improper operation occurs at anytime during the Initial Test, unplug the units and refer to the In Case Of Difficulty section of the manual.

Set the controls of the two units as follows:

VOLUME controls fully counterclockwise.

Bar knobs in the REC position.

Channel switch (top of chassis) in the HI position.

Set the two Intercom stations facing each other, with the speakers about 12" apart. Plug both Intercoms into a 117 volt AC outlet.

You will note that the clear RECEIVE pilot lamp of each unit lights up. Press down the bar knob of one unit to the TRANSMIT position. The red TRANSMIT pilot lamp should light, and a squeal should be heard from the speaker of the other unit. If no sound is heard, gradually turn up the VOLUME control of the other unit until a squeal is heard. Let up the bar knob of the one unit to its REC position. Repeat this procedure, using the bar knob of the other unit.

If operation seems normal, proceed to Final Assembly.

FINAL ASSEMBLY

Refer to Pictorial 6 for the following steps.

() Snap the plug button in the large hole in the rear of the base cabinet.

() Pass the speaker in through the front opening of the cabinet base, and out through the top opening.

() Slide the chassis into the cabinet and at the same time pull the line cord out through the grommet until the chassis is in place.

() Mount the speaker on the speaker bracket with 6-32 x 3/8" screws.

() Secure the chassis to the cabinet base with two #6 x 3/8" sheet metal screws.

() Fit the cabinet top onto the cabinet base, and snap it in place.

() Remove the protective backing from the nameplate and press it in the molded oval of the cabinet top.

This completes assembly of the Intercom.

OPERATION

The Intercom can be used on either an AC or DC power line. The line voltage should be between 105 and 125 volts. When used on a DC power line, however, the plug must be properly polarized; that is, if it is used on a DC power source and will not operate, it will be necessary to reverse the power plug of either or both Intercom stations. No damage will result if the Intercom is plugged in backwards.

You have probably noticed that the Intercom does not have an off-on switch. When the Inter-

com is in the REC position, its power consumption will be about the same as that of an electric clock. For this reason, it is both convenient and economical to leave the Intercom stations turned on at all times.

The Intercom stations use the power line wiring between them as the interconnecting Intercom wiring. Operating distances of from a few hundred feet in commercial areas to one or two blocks in residential areas can be expected, provided that the Intercoms are operated on the

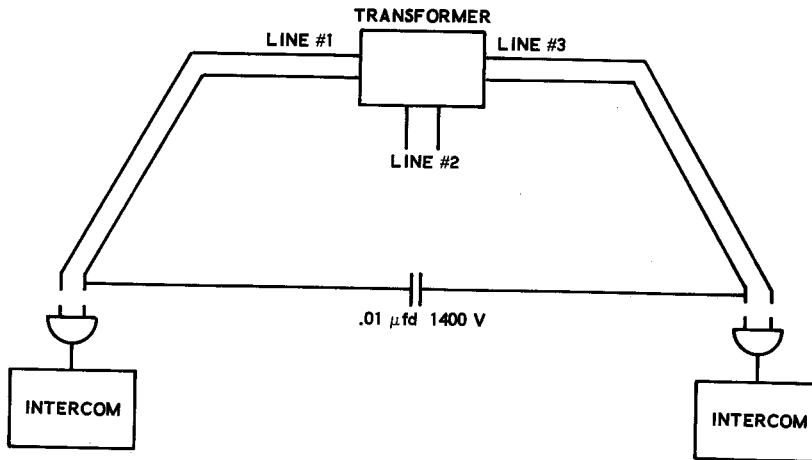

Figure 1

same power line. The line transformers used by the power company will generally be the main factor in limiting operating distance. The Intercoms will not operate satisfactorily across a transformer, from one power line to another.

Some difficulty may be encountered when using an Intercom system on a 3-phase power source. In 3-phase power wiring, each of the three resulting power lines, in a sense, separated from the others by the line transformer. Before all of the Intercom stations can communicate with each other, it may be necessary to connect a .01 μ fd 1400 volt capacitor from either wire of the power line for one Intercom to either wire of the power line for the other Intercoms.

For example, in a 3-phase power system, two Intercoms could be in adjacent rooms, but operated from different power lines. In this case the electrical distance between the units would include the power wiring from the first unit to the line transformer, plus the power wiring from the transformer back to the second unit. To shorten this "electrical" distance, a .01 μ fd 1400 V capacitor could be connected between the power lines for the two Intercoms as shown in Figure 1. A separate wire would be needed between the two units.

If the remedy just described becomes necessary, the work should be performed only by a qualified electrician.

FRONT PANEL CONTROLS

THE BAR KNOB will normally be left in the

REC position. To talk to another unit, the bar knob can be pressed down to the TRANSMIT position; when released, it will automatically return to the REC position. It can also be moved up to the DICTATE position, where it locks in until returned to the REC position. The TRANSMIT and DICTATE positions are electrically the same.

NOTE: It is not necessary to shout into the unit; talk at a normal level approximately 2 to 3 feet from the speaker.

THE VOLUME CONTROL is adjusted for the desired level when receiving. It has no effect on the transmitting level. The VOLUME control circuit is designed so that the volume cannot be turned completely off, even though the VOLUME control might be turned to the LOW, fully counterclockwise, position. With the VOLUME control in the LOW position, you should still be able to hear a call a few feet away, depending on the noise level of the area.

THE CLEAR RECEIVE PILOT LAMP should be on when the bar knob is in the REC position. It will go off, and the red TRANSMIT lamp will light when the bar knob is moved to either the TRANSMIT or the DICTATE position.

THE CHANNEL SWITCH on top of the chassis must be in the same position, either HI or LO, on all Intercom units; if others on your power line also have these same types of Intercoms, you can change the CHANNEL switch to its other position and eliminate interference with each other.

IN CASE OF DIFFICULTY

1. Recheck the wiring. Trace each lead in colored pencil on the Pictorial as it is checked. It is frequently helpful to have a friend check your work. Someone who is not familiar with the unit may notice something consistently overlooked by the constructor.
2. It is interesting to note that about 90% of the kits that are returned for repair, do not function properly due to poor connections and soldering. Therefore, many troubles can be eliminated by reheating all connections to make sure that they are soldered as described in the Proper Soldering Techniques section of this manual.
3. Check the values of the component parts. Be sure that the proper part has been wired into the circuit, as shown in the pictorial diagrams and as called out in the wiring instructions.
4. Check for bits of solder, wire ends or other foreign matter which may be lodged in the wiring beneath the chassis.
5. If, after careful checks, the trouble is still not located and a voltmeter is available, check voltage readings against those found on the Schematic Diagram. NOTE: All voltage readings were taken with an 11 megohm input vacuum tube voltmeter. Voltages may vary as much as 10% due to line voltage variations.
6. A review of the Circuit Description will prove helpful in indicating where to look for trouble.
7. Be sure to check the fuse, which is a piece of #39 or 40 wire between lugs 3 and 2 of line coil L1.
8. If it is found that improper alignment is responsible for unsatisfactory operation, the Intercoms may be aligned, using the following procedure.

ALIGNMENT USING AN ISOLATION TRANSFORMER, RF SIGNAL GENERATOR, OSCILLOSCOPE, AND A VTVM

1. Connect the vertical input of the oscilloscope across lugs 1 and 3 of line coil L1;

the scope ground lead goes to lug 3. Connect the RF signal generator to the horizontal input of the oscilloscope; the ground lead from the generator should be connected to the ground terminal of the scope. Set the generator to produce a 220 kc unmodulated output. Plug the Intercom into the isolation transformer and set the bar knob to the DICTATE position. Also set the CHANNEL switch to the HI position.

2. Adjust oscillator coil L2 very slowly until an oval Lissajous figure appears on the scope. Adjust line coil L1 for maximum height of the figure on the scope.
3. Adjusting L1 may affect the frequency adjustment slightly, therefore, it may be necessary to readjust L2 to again produce the Lissajous figure on the scope.

Repeat the above adjustments on all Intercom units.

4. Connect the output of the generator to the AC line of the Intercom through a .05 μ f 600 V capacitor in series with each lead. Set the generator to 30% modulation at 220 kc.

Connect the AC test leads of the VTVM to lug 4 (the emitter of X4) and lug 1 (the collector of X4) of terminal strip F. Keep the generator output at a level which produces approximately a 1 volt reading on the VTVM.

Adjust the slug of T1 for a 1 volt reading on the VTVM with the lowest possible generator output level.

5. Repeat the above adjustment for all of the other Intercom units.
6. Unplug the Intercom units from the isolation transformer, then disconnect the meter and the speaker shorting wire.

NOTE: It is not necessary to realign the Intercoms if the CHANNEL switch is used in LO position. Precision shunting capacitors are used to maintain the proper operating frequency.

SERVICE INFORMATION

SERVICE

If, after applying the information contained in this manual and your best efforts, you are still unable to obtain proper performance, it is suggested that you take advantage of the technical facilities which the Heath Company makes available to its customers.

The Technical Consultation Department is maintained for your benefit. This service is available to you at no charge. Its primary purpose is to provide assistance for those who encounter difficulty in the construction, operation or maintenance of HEATHKIT equipment. It is not intended, and is not equipped to function as a general source of technical information involving kit modifications nor anything other than the normal and specified performance of HEATHKIT equipment.

Although the Technical Consultants are familiar with all details of this kit, the effectiveness of their advice will depend entirely upon the amount and the accuracy of the information furnished by you. In a sense, YOU MUST QUALIFY for GOOD technical advice by helping the consultants to help you. Please use this outline:

1. Before writing, fully investigate each of the hints and suggestions listed in this manual under In Case Of Difficulty. Possibly it will not be necessary to write.
2. When writing, clearly describe the nature of the trouble and mention all associated equipment. Specifically report operating procedures, switch positions, connections to other units and anything else that might help to isolate the cause of trouble.
3. Report fully on the results obtained when testing the unit initially and when following the suggestions under In Case Of Difficulty. Be as specific as possible and include voltage readings if test equipment is available.
4. Identify the kit model number and date of purchase, if available. Also mention the date of the kit assembly manual. (Date at bottom of Page 1.)
5. Print or type your name and address, preferably in two places on the letter.

With the preceding information, the consultant will know exactly what kit you have, what you would like it to do for you and the difficulty you wish to correct. The date of purchase tells him whether or not engineering changes have been made since it was shipped to you. He will know what you have done in an effort to locate the cause of trouble and, thereby, avoid repetitious suggestions. In short, he will devote full time to the problem at hand, and through his familiarity with the kit, plus your accurate report, he will be able to give you a complete and helpful answer. If replacement parts are required, they will be shipped to you, subject to the terms of the Warranty.

The Factory Service facilities are also available to you, in case you are not familiar enough with electronics to provide our consultants with sufficient information on which to base a diagnosis of your difficulty, or in the event that you prefer to have the difficulty corrected in this manner. You may return the completed instrument to the Heath Company for inspection and necessary repairs and adjustments. You will be charged a minimal service fee, plus the price of any additional parts or material required. However, if the completed kit is returned within the Warranty period, parts charges will be governed by the terms of the Warranty. State the date of purchase, if possible.

Local Service by Authorized HEATHKIT Service Centers is also available in some areas and often will be your fastest, most efficient method of obtaining service for your HEATHKIT equipment. Although you may find charges for local service somewhat higher than for factory service, the amount of increase is usually offset by the transportation charge you would pay if you elected to return your kit to the Heath Company.

HEATHKIT Service Centers will honor the regular 90 day HEATHKIT Parts Warranty on all kits, whether purchased through a dealer or directly from Heath Company; however, it will be necessary that you verify the purchase date of your kit.

Under the conditions specified in the Warranty, replacement parts are supplied without charge; however, if the Service Center assists you in



locating a defective part (or parts) in your kit, or installs a replacement part for you, you may be charged for this service.

HEATHKIT equipment purchased locally and returned to Heath Company for service must be accompanied by your copy of the dated sales receipt from your authorized HEATHKIT dealer in order to be eligible for parts replacement under the terms of the Warranty.

THIS SERVICE POLICY APPLIES ONLY TO COMPLETED EQUIPMENT CONSTRUCTED IN ACCORDANCE WITH THE INSTRUCTIONS AS STATED IN THE MANUAL. Equipment that has been modified in design will not be accepted for repair. If there is evidence of acid core solder or paste fluxes, the equipment will be returned NOT repaired.

For information regarding modification of HEATHKIT equipment for special applications, it is suggested that you refer to any one or more of the many publications that are available on all phases of electronics. They can be obtained at or through your local library, as well as at most electronic equipment stores. Although the Heath Company sincerely welcomes all comments and suggestions, it would be impossible to design, test, evaluate and assume responsibility for proposed circuit changes for special purposes. Therefore, such modifications must be made at the discretion of the kit builder, using information available from sources other than the Heath Company.

REPLACEMENTS

Material supplied with HEATHKIT products has been carefully selected to meet design requirements and ordinarily will fulfill its function without difficulty. Occasionally improper instrument operation can be traced to a faulty component. Should inspection reveal the necessity for replacement, write to the Heath Company and supply all of the following information.

- A. Thoroughly identify the part in question by using the part number and description found in the manual Parts List.
- B. Identify the type and model number of kit in which it is used.

C. Mention date of purchase.

D. Describe the nature of defect or reason for requesting replacement.

The Heath Company will promptly supply the necessary replacement. **PLEASE DO NOT RETURN THE ORIGINAL COMPONENT UNTIL SPECIFICALLY REQUESTED TO DO SO.** Do not dismantle the component in question as this will void the guarantee. This replacement policy does not cover the free replacement of parts that may have been broken or damaged through carelessness on the part of the kit builder.

SHIPPING INSTRUCTIONS

In the event that your instrument must be returned for service, these instructions should be carefully followed.

Wrap the equipment in heavy paper, exercising care to prevent damage. Place the wrapped equipment in a stout carton of such size that at least three inches of shredded paper, excelsior, or other resilient packing material can be placed between all sides of the wrapped equipment and the carton. Close and seal the carton with gummed paper tape, or alternately, tie securely with stout cord. Clearly print the address on the carton as follows:

To: **HEATH COMPANY**
Benton Harbor, Michigan

ATTACH A LETTER TO THE OUTSIDE OF THE CARTON BEARING YOUR NAME, COMPLETE ADDRESS, DATE OF PURCHASE, AND A BRIEF DESCRIPTION OF THE DIFFICULTY ENCOUNTERED. Also, include your name and return address on the outside of the carton. Preferably affix one or more "Fragile" or "Handle With Care" labels to the carton, or otherwise so mark with a crayon of bright color. Ship by insured parcel post or prepaid express; note that a carrier cannot be held responsible for damage in transit if, in HIS OPINION, the article is inadequately packed for shipment.

WARRANTY

Heath Company warrants that for a period of three months from the date of shipment, all Heathkit parts shall be free of defects in materials and workmanship under normal use and service and that in fulfillment of any breach of such warranty, Heath Company shall replace such defective parts upon the return of the same to its factory. The foregoing warranty shall apply only to the original buyer, and is and shall be in lieu of all other warranties, whether express or implied and of all other obligations or liabilities on the part of Heath Company and in no event shall Heath Company be liable for any anticipated profits, consequential damages, loss of time or other losses incurred by the buyer in connection with the purchase, assembly or operation of Heathkits or components thereof. No replacement shall be made of parts damaged by the buyer in the course of handling or assembling Heathkit equipment.

NOTE: The foregoing warranty is completely void and we will not replace, repair or service instruments or parts thereof in which acid core solder or paste fluxes have been used.

HEATH COMPANY

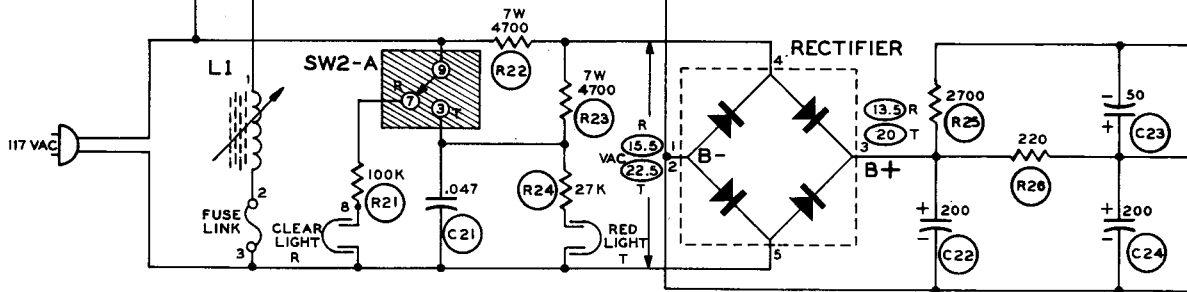
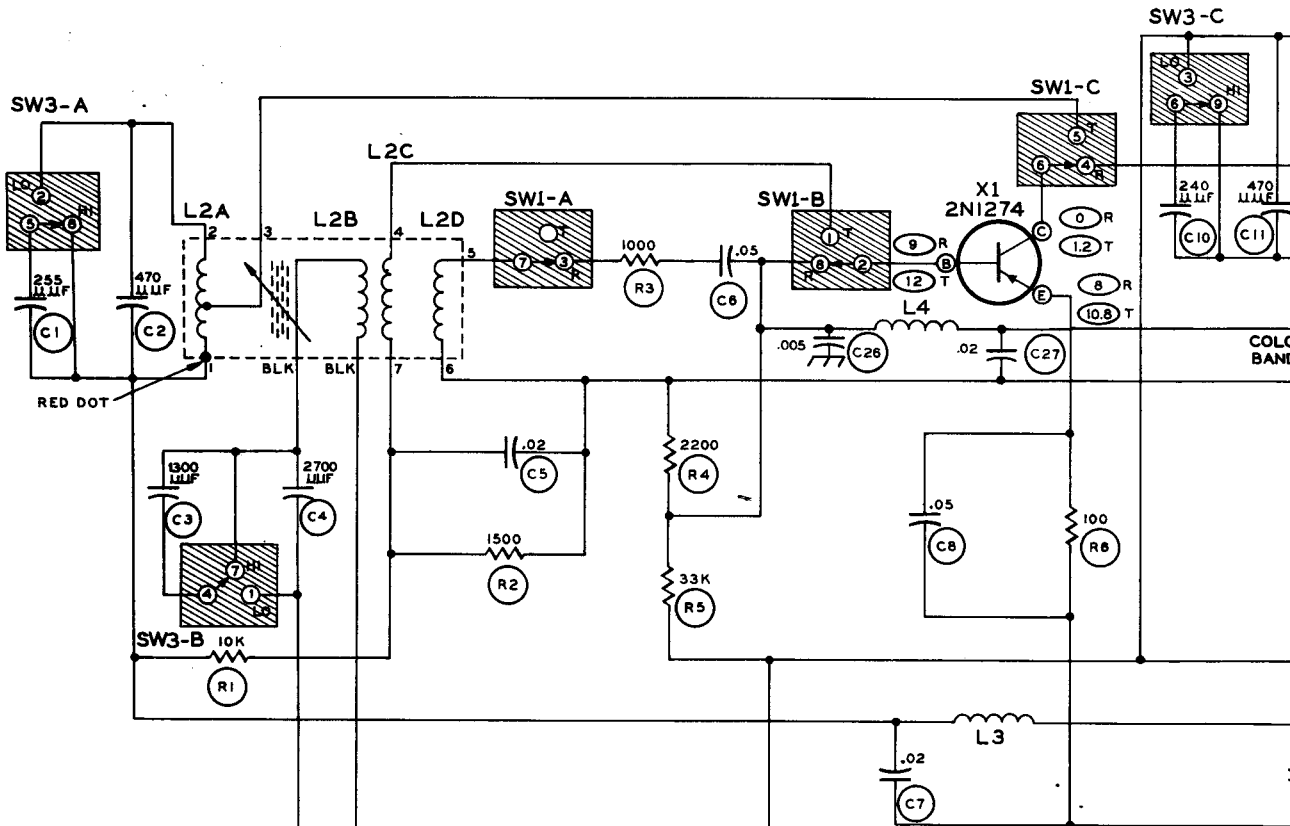

SW1 SWITCH T

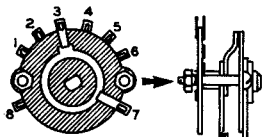

SW2 SWITCH S

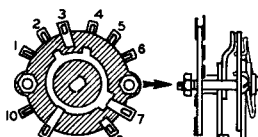

SW3 SWITCH L

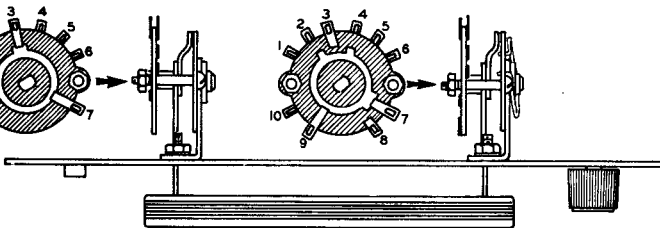
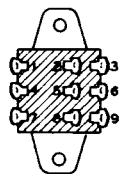

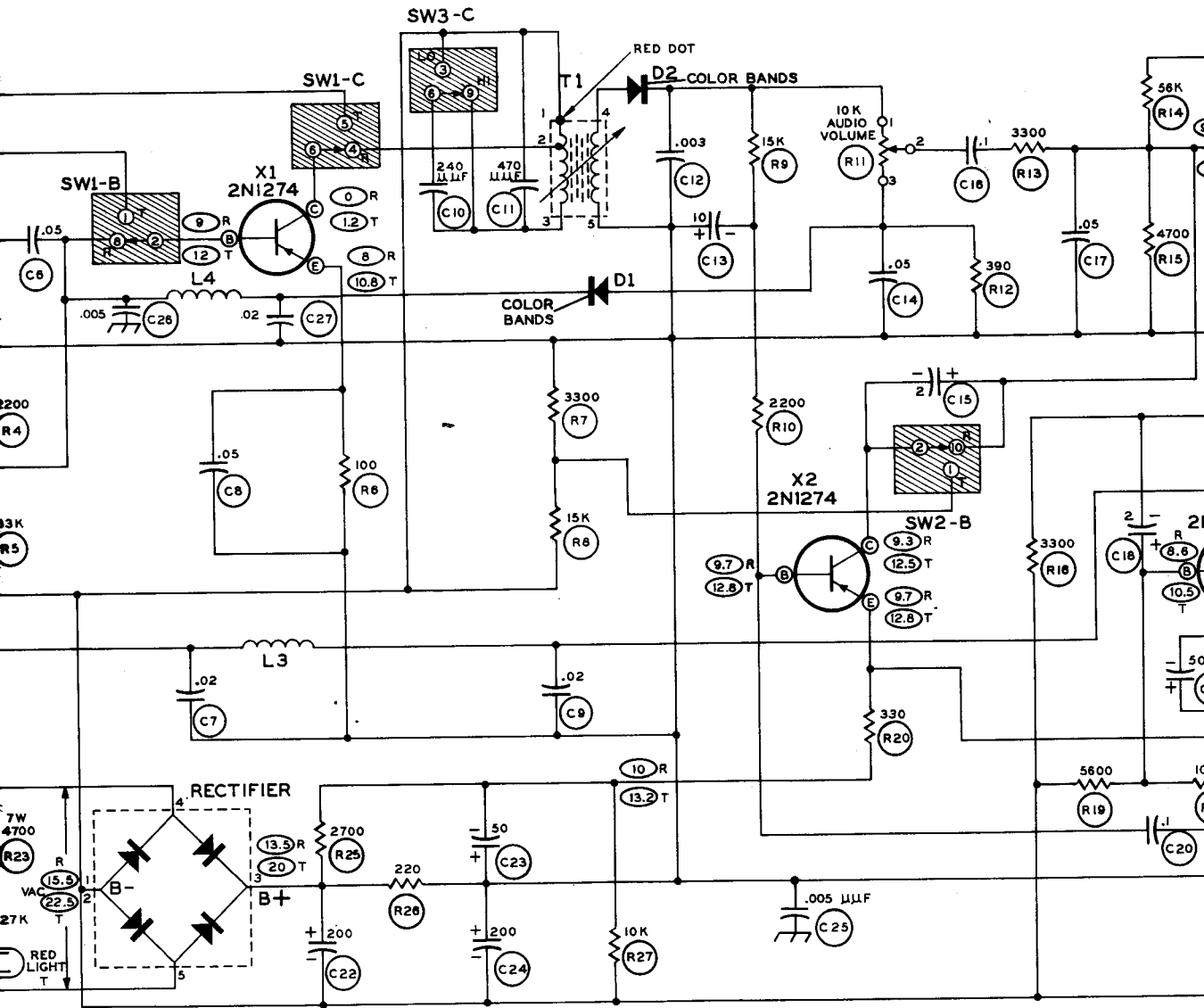

4 S

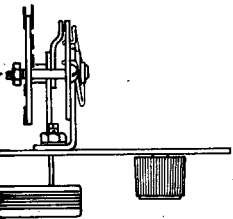

SW3 SWITCH L

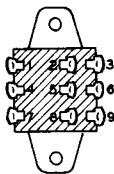

SCHEMATIC OF THE HEATHKIT® WIRELESS INTERCOM MODEL GD-51

ALL CAPACITOR VALUES ARE μfd UNLESS SPECIFIED.
ALL RESISTOR VALUES ARE IN OHMS, K = 1000.
ALL RESISTORS ARE 1/2 WATT UNLESS SPECIFIED.
○ INDICATES VOLTAGE READINGS.
T = TRANSMIT OR DICTATE POSITION.
R = RECEIVER POSITION.

ALL VOLTAGES ARE DC WITH REFERENCE TO CHASSIS GND, EXCEPT AC VOLTAGES AT INPUT OF RECTIFIER.
ALL VOLTAGES TAKEN WITH 11 MEGOHM INPUT IMPEDANCE.

SW1 AND SW2 SHOWN IN REC. POSITION.

CHASSIS GND.

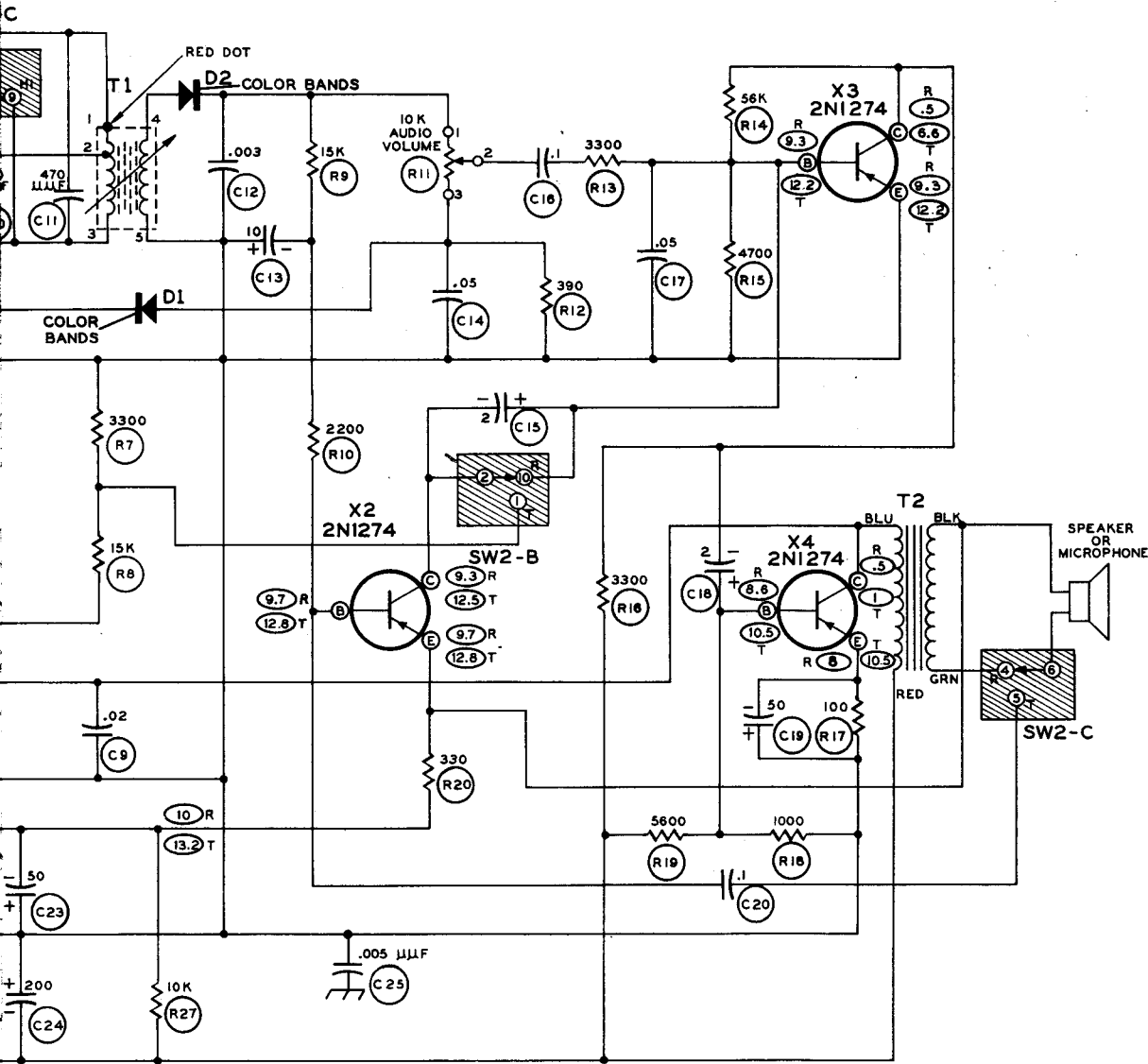

**SCHEMATIC OF THE
HEATHKIT®
WIRELESS INTERCOM
MODEL GD-51**

ALL CAPACITOR VALUES ARE μfd UNLESS SPECIFIED OTHERWISE.

ALL RESISTOR VALUES ARE IN OHMS, K = 1000.

ALL RESISTORS ARE 1/2 WATT UNLESS SPECIFIED OTHERWISE.

○ INDICATES VOLTAGE READINGS.

T = TRANSMIT OR DICTATE POSITION.

R = RECEIVER POSITION.

ALL VOLTAGES ARE DC WITH REFERENCE TO LUG 1 OF RECTIFIER
Q, EXCEPT AC VOLTAGES AT INPUT OF RECTIFIER.

ALL VOL TAGES TAKEN WITH 11 MEGOHM INPUT VTVM, 117 VOLT LINE
SOURCE.











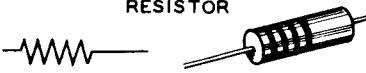

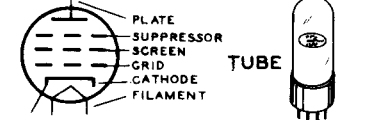
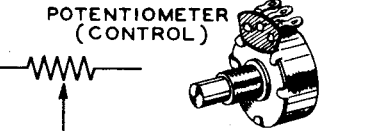
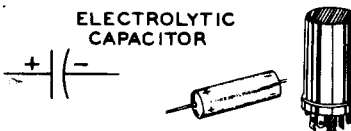

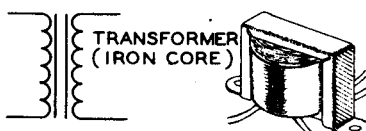
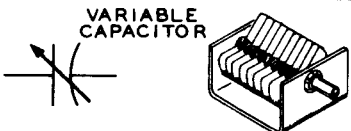
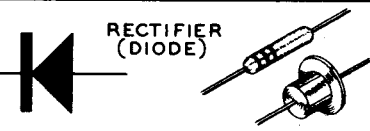
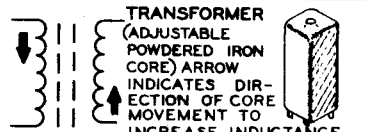
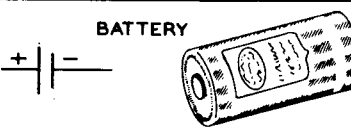
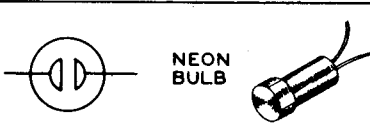
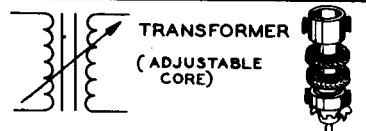

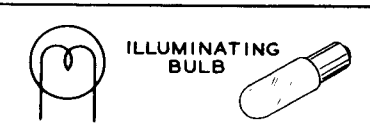
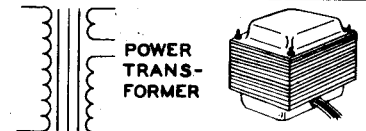
SW1 AND SW2 SHOWN IN REC. POSITION.

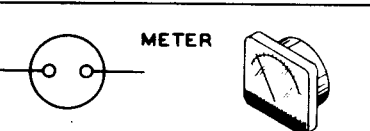
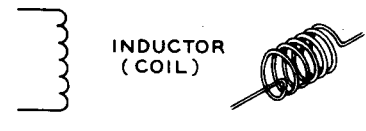
⏏ CHASSIS GND.

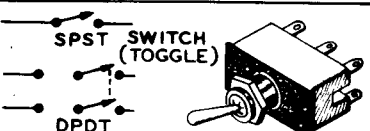
TYPICAL COMPONENT TYPES

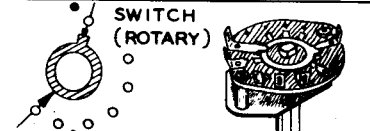
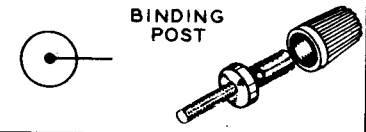
This chart is a guide to commonly used types of electronic components. The symbols and related illustrations

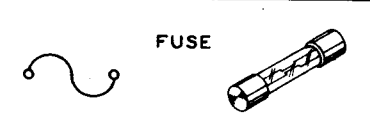
should prove helpful in identifying most parts and reading the schematic diagrams.

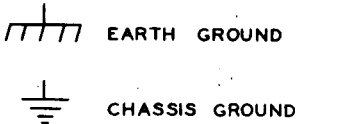
<p style="text-align: center;">RESISTOR</p> 	<p style="text-align: center;">CAPACITOR</p> 	<p style="text-align: center;">TUBE</p> 
<p style="text-align: center;">POTENTIOMETER (CONTROL)</p> 	<p style="text-align: center;">ELECTROLYTIC CAPACITOR</p> 	<p style="text-align: center;">TRANSISTOR</p> 
<p style="text-align: center;">TRANSFORMER (IRON CORE)</p> 	<p style="text-align: center;">VARIABLE CAPACITOR</p> 	<p style="text-align: center;">RECTIFIER (DIODE)</p> 
<p style="text-align: center;">TRANSFORMER (ADJUSTABLE POWDERED IRON CORE) ARROW INDICATES DIRECTION OF CORE MOVEMENT TO INCREASE INDUCTANCE</p> 	<p style="text-align: center;">BATTERY</p> 	<p style="text-align: center;">NEON BULB</p> 
<p style="text-align: center;">TRANSFORMER (ADJUSTABLE CORE)</p> 	<p style="text-align: center;">PHONO JACK</p> 	<p style="text-align: center;">ILLUMINATING BULB</p> 
<p style="text-align: center;">POWER TRANSFORMER</p> 	<p style="text-align: center;">PHONE JACK</p> 	<p style="text-align: center;">METER</p> 
<p style="text-align: center;">INDUCTOR (COIL)</p> 	<p style="text-align: center;">RECEPTACLE</p> 	<p style="text-align: center;">SPST SWITCH (TOGGLE) DPDT</p> 
<p style="text-align: center;">PIEZOELECTRIC CRYSTAL</p> 	<p style="text-align: center;">SPEAKER</p> 	<p style="text-align: center;">SWITCH (ROTARY)</p> 
<p style="text-align: center;">BINDING POST</p> 	<p style="text-align: center;">MICROPHONE</p> 	<p style="text-align: center;">FUSE</p> 
<p style="text-align: center;">ANTENNA GENERAL LOOP</p> 	<p style="text-align: center;">EARTH GROUND CHASSIS GROUND</p> 	<p style="text-align: center;">CONDUCTORS NOT CONNECTED CONNECTED SHIELDED</p> 