

HEATH COMPANY BENTON HARBOR, MICHIGAN

JAMES D. MC WILLIAMS
1331 THOUSAND OAKS
ALBANY, CALIF.

PRICE \$1.00

HEATHKIT® ASSEMBLY MANUAL

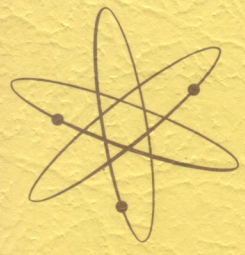

COMPACT HIGH FIDELITY SPEAKER SYSTEM

MODEL AS-193

RESISTOR AND CAPACITOR COLOR CODES

RESISTORS

The colored bands around the body of a color coded resistor represent its value in ohms. These colored bands are grouped toward one end of the resistor body. Starting with this end of the resistor, the first band represents the first digit of the resistance value; the second band represents the second digit; the third band represents the number by which the first two digits are multiplied. A fourth band of gold or silver represents a tolerance of $\pm 5\%$ or $\pm 10\%$ respectively. The absence of a fourth band indicates a tolerance of $\pm 20\%$.

The physical size of a composition resistor is related to its wattage rating. Size increases progressively as the wattage rating is increased. The diameters of 1/2 watt, 1 watt and 2 watt resistors are approximately 1/8", 1/4" and 5/16", respectively.

The color code chart and examples which follow provide the information required to identify color coded resistors.

COLOR	CODE		MULTIPLIER
	1ST DIGIT	2ND DIGIT	
BLACK	0	0	1
BROWN	1	1	10
RED	2	2	100
ORANGE	3	3	1,000
YELLOW	4	4	10,000
GREEN	5	5	100,000
BLUE	6	6	1,000,000
VIOLET	7	7	10,000,000
GRAY	8	8	100,000,000
WHITE	9	9	1,000,000,000
GOLD	-	-	.1
SILVER	-	-	.01



TOLERANCE
 GOLD $\pm 5\%$
 SILVER $\pm 10\%$
 NO BAND $\pm 20\%$

EXAMPLES

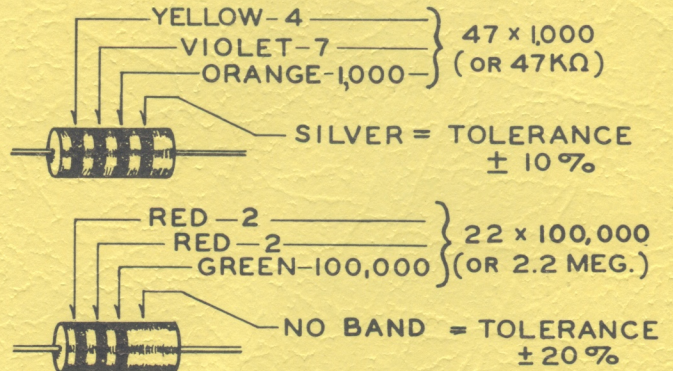

CAPACITORS

Generally, only mica and tubular ceramic capacitors, used in modern equipment, are color coded. The color codes differ somewhat among capacitor manufacturers, however the codes

shown below apply to practically all of the mica and tubular ceramic capacitors that are in common use. These codes comply with EIA (Electronics Industries Association) Standards.

MICA

COLOR	CODE		MULTIPLIER	TOLER. %
	1ST DIGIT	2ND DIGIT		
BLACK	0	0	1	± 20
BROWN	1	1	10	± 20
RED	2	2	100	± 5
ORANGE	3	3	1,000	± 5
YELLOW	4	4	10,000	± 5
GREEN	5	5	—	—
BLUE	6	6	—	—
VIOLET	7	7	—	—
GRAY	8	8	—	—
WHITE	9	9	—	—
GOLD	-	-	.1	± 10
SILVER	-	-	.01	± 10

EXAMPLE

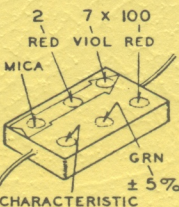

2700 μf $\pm 5\%$
 OR .0027 μf

OBSERVE DIRECTION OF ARROW

WHT. OR BLK. DOT INDICATES MICA

CHARACTERISTIC—SEE NOTE 1 BELOW

(VALUE IN μf —SEE NOTE 3 BELOW)

TUBULAR CERAMIC

Place the group of rings or dots to the left and read from left to right.

COLOR	CODE		MULTIPLIER	TOLER. %	
	1ST DIGIT	2ND DIGIT		OR LESS	OR 10
BLACK	0	0	1	± 20	± 20
BROWN	1	1	10	± 0.1	± 1
RED	2	2	100	—	± 2
ORANGE	3	3	1,000	—	± 2.5
YELLOW	4	4	10,000	—	—
GREEN	5	5	—	± 0.5	± 5
BLUE	6	6	—	—	—
VIOLET	7	7	—	—	—
GRAY	8	8	—	± 0.25	—
WHITE	9	9	—	± 1.0	± 10

EXAMPLE

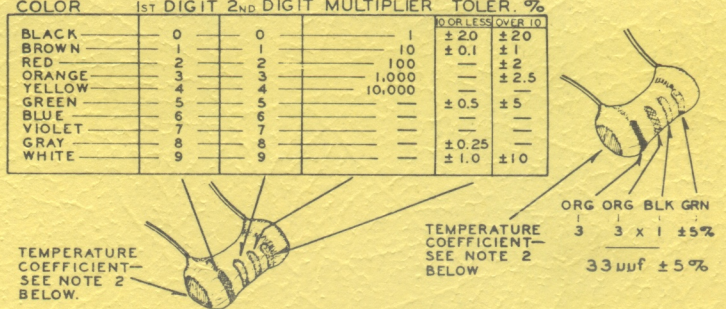

(VALUE IN μf —SEE NOTE 3 BELOW)

NOTES:

1. The characteristic of a mica capacitor is the temperature coefficient, drift capacitance and insulation resistance. This information is not usually needed to identify a capacitor but, if desired, it can be obtained by referring to EIA Standard, RS-153 (a Standard of Electronic Industries Association.)

2. The temperature coefficient of a capacitor is the predictable change in capacitance with temperature change and is

expressed in parts per million per degree centigrade. Refer to EIA Standard, RS-198 (a Standard of Electronic Industries Association.)

3. The farad is the basic unit of capacitance, however capacitor values are generally expressed in terms of μf (microfarad, .000001 farad) and $\mu\mu\text{f}$ (micro-micro-farad, .000001 μf); therefore, 1,000 $\mu\mu\text{f}$ = .001 μf , 1,000,000 $\mu\mu\text{f}$ = 1 μf .

USING A PLASTIC NUT STARTER

A plastic nut starter offers a convenient method of starting the most used sizes: 3/16" and 1/4" (3-48 and 6-32). When the correct end is pushed down over a nut, the pliable tool conforms to the shape of the nut and the nut is gently held while it is being picked up and started on the screw. The tool should only be used to start the nut.

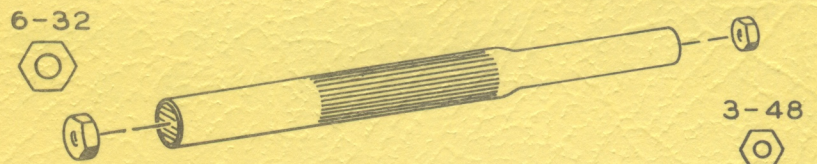

Assembly
and
Operation
of the



COMPACT HIGH FIDELITY SPEAKER SYSTEM

MODEL AS-193

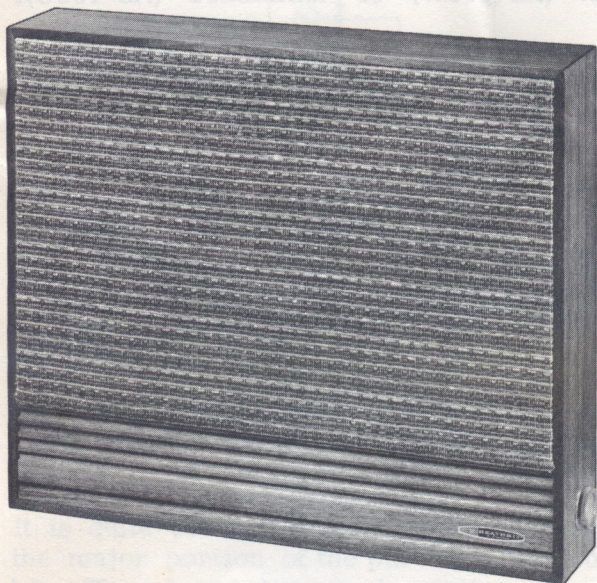

HEATH COMPANY,
BENTON HARBOR,
MICHIGAN

DAYSTROM, INCORPORATED
a subsidiary of

TABLE OF CONTENTS

Specifications	2
Introduction	3
Unpacking Instructions	3
Parts List	4
Cabinet Finishing Notes	5
Proper Soldering Techniques	5
Step-By-Step Procedure	6
Step-By-Step Assembly	6
Initial Test	9
In Case Of Difficulty	9
Service Information	
Service	10
Replacements	11
Shipping Instructions	11
Warranty	12

SPECIFICATIONS

Frequency Response.	65 to 14,000 cps.
Nominal Impedance.	8 Ω.
Recommended Amplifier Power.	6 watts.
Crossover Frequency.	4000 cps.
Crossover.	Capacitance-inductance type.
Speakers.	Woofers: 5-1/2" cone type, 5.8 oz. magnet. Tweeters (2): 3" cone type, closed back, .53 oz.
Volume Control.	30 Ω, wire-wound.
CABINET -	
Type.	Infinite.
Dimensions.	15-5/8" wide x 12-7/8" high x 2-3/4" deep.
Finish.	Walnut (AS-193W) or unfinished (AS-193U).
Net Weight.	9 lbs.
Shipping Weight.	10 lbs. 8 oz.

All prices are subject to change without notice. The Heath Company reserves the right to discontinue instruments and to change specifications at

any time without incurring any obligation to incorporate new features in instruments previously sold.

INTRODUCTION

Your new Heathkit Compact High Fidelity Speaker System is designed to provide excellent wide-range audio reproduction from a small, infinite-type enclosure. Outstanding performance is achieved by using one woofer speaker, two tweeter speakers, a capacitance-inductance crossover, and a special acoustic enclosure in an integrated design.

The high compliance woofer speaker is designed for optimum performance in a small airtight enclosure. The closed-back design of the two tweeters eliminates speaker interaction. All components are balanced for relatively level

frequency response. The tonal balance you desire is achieved by adjusting the tone controls of your amplifier. A Volume control is provided to adjust the sound output of the Speaker System. If several Speaker Systems are used in remote locations, the volume of each System may be adjusted individually.

Assembly of the Speaker System is simple. If the step-by-step instructions are followed closely, no difficulty should be encountered. We suggest you take a few minutes now to read the entire manual through before any work is started.

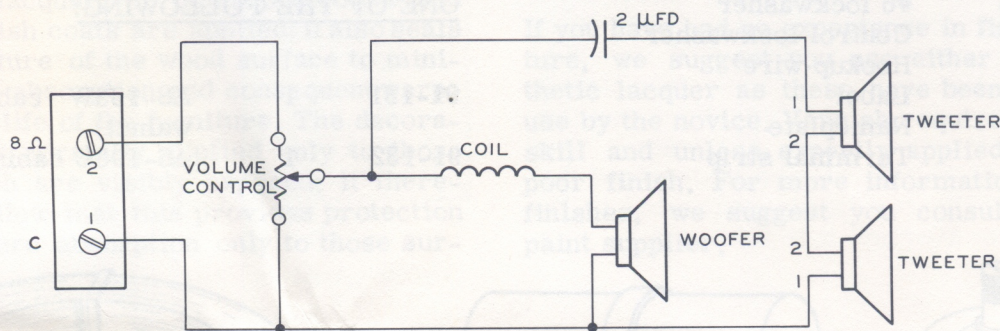

**SCHEMATIC OF THE
HEATHKIT
MODEL AS-193
COMPACT HI-FI SPEAKER SYSTEM**

UNPACKING INSTRUCTIONS

It is quite obvious that the speakers represent the major portion of the purchase price of this kit. Therefore, too much caution cannot be exercised in handling the speakers.

UNPACK THE KIT CAREFULLY AND CHECK EACH PART AGAINST THE PARTS LIST. In so doing, you will become acquainted with the parts. If some shortage or parts damage is found in checking the parts, please read the Replacements section of this manual and supply the information called for therein. Include all inspection slips in your letter to us.

We suggest that you do the following before work is started.

1. Lay out all parts so that they are readily available.
2. Provide yourself with good quality tools. Basic requirements consist of: a screwdriver with a 1/4" blade; a phillips screwdriver; long-nose pliers; wire cutters; a pen knife or a tool for stripping insulation from wires; a soldering iron (or gun); and rosin core solder.

PARTS LIST

The numbers in parentheses in the Parts List are keyed to the numbers on the parts drawings to aid in parts identification.

PART No.	PARTS Per Kit	DESCRIPTION	PART No.	PARTS Per Kit	DESCRIPTION
(1) 11-55	1	30 Ω 4 watt control	(14) 462-206	1	Control knob
(2) 23-85	1	2 μ fd tubular capacitor	401-67	2	3" speaker
(3) 40-600	1	1.95 mh coil	401-96	1	5-1/2" speaker
(4) 250-8	8	#6 x 3/8" sheet metal screw	331-6		Solder
(5) 250-162	2	6-23 x 1/2" screw	595-686	1	Manual
(6) 252-3	6	6-32 nut			
(7) 252-7	1	Control nut			
(8) 253-10	1	Control flat washer			
(9) 254-1	6	#6 lockwasher			
(10) 254-4	1	Control lockwasher			
344-1	1	Hookup wire			
(11) 390-144	1	Label	91-131	1	AS-193W cabinet (finished walnut)
(12) 391-17	1	Nameplate	91-132	1	AS-193U cabinet (unfinished)
(13) 431-6	1	Terminal strip			

ONE OF THE FOLLOWING:

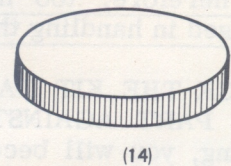
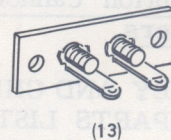
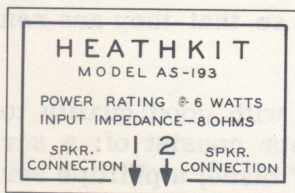
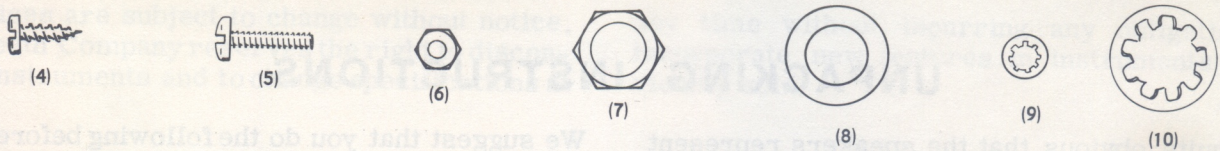
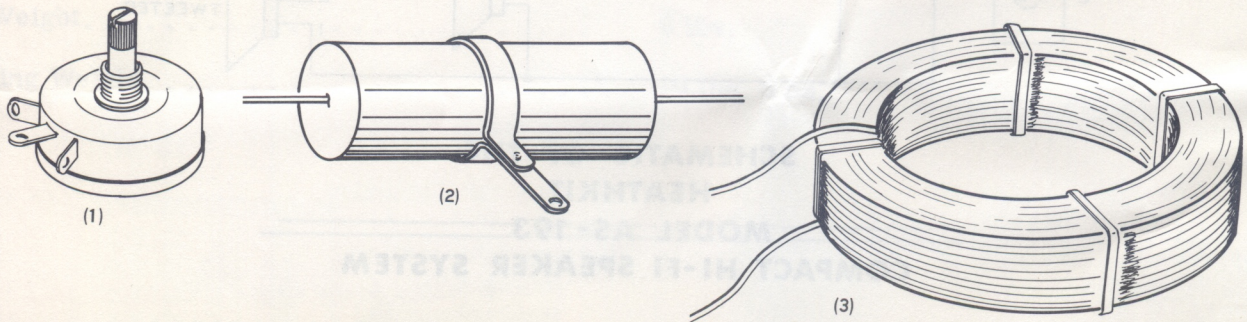

(11)

(12)

(13)

(14)

CABINET FINISHING NOTES

NOTE: If you purchased the AS-193U Speaker System and the cabinet is to be finished, it should be done at this time.

It is not the objective of these notes to provide finishing instructions. Many good finish systems and appropriate materials are available; regardless of which system you use, follow the supplier's instructions explicitly. However, an early step in any system of finishing, after preparation of the wood surface, is the application of a "filler" or "sealer." The purpose of this treatment is at least twofold. It fills the pores or surface cells of the wood, thereby providing a uniformly smooth, hard surface over which the varnish, lacquer, or other protective and beautifying finish coats are applied; it also seals the cell structure of the wood surface to minimize moisture absorption and consequent warping during the life of the furniture. The decorative finish is normally applied only to those surfaces which are visibly exposed; it therefore would follow that this provides protection against moisture absorption only to those sur-

faces, and leaves a condition which is conducive to warping. It is therefore strongly recommended that one or more coats of a good liquid sealer be applied to all surfaces, exterior and interior, to which the decorative finish is not applied. This should be done immediately following application of the specified filler or sealer to the surfaces which will receive the decorative finish.

A careful sanding with fine sandpaper before applying the finish is recommended. There are many types of finishes available on the market today, such as wax, synthetic lacquer, hard lacquer, and varnish.

If you have had no experience in finishing furniture, we suggest you use either wax or synthetic lacquer as these have been designed for use by the novice. Varnish requires much more skill and unless expertly applied, will give a poor finish. For more information on cabinet finishes, we suggest you consult your local paint supplier.

PROPER SOLDERING TECHNIQUES

Only a small percentage of customers find it necessary to return equipment for factory service. By far the largest portion of malfunctions in this equipment are due to poor or improper soldering.

If terminals are bright and clean and free of wax, frayed insulation and other foreign substances, no difficulty will be experienced in soldering. Correctly soldered connections are essential if the performance engineered into a kit is to be fully realized. If you are a beginner with no experience in soldering, a few minutes practice with some odd lengths of wire may be a worthwhile investment.

For most wiring, a 25 to 100 watt iron or its equivalent in a soldering gun is very satisfactory. A lower wattage iron than this may not heat the connection enough to flow the solder smoothly. Keep the iron tip clean by wiping it from time to time with a cloth.

WIRING AND SOLDERING

1. Unless otherwise indicated, all wire used is the type with colored insulation (hookup wire). In preparing a length of hookup wire, 1/4" of insulation should be removed from each end unless directed otherwise in the assembly step.
2. Crimp or bend the wire around the terminal just enough to hold it in place until it is soldered. Do not twist or knot the wire around the terminal.

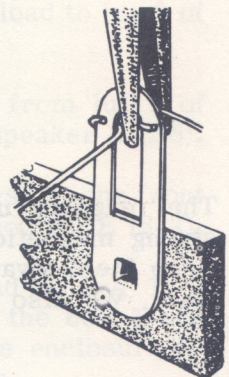

3. When soldering, position the work, if possible, so that gravity will help to keep the solder where you want it. The joint to be soldered should be heated with the flat side of the soldering iron tip sufficiently to melt the solder. Apply only enough solder to the heated terminal to thoroughly wet the junction. Remove the solder and then the iron when a smooth soldered junction appears. Do not move the wires until the solder is solidified.
4. The abbreviation "NS" indicates that a connection should not be soldered yet as other wires will be added. When the last wire is installed, the terminal should be soldered and the abbreviation "S" is used to indicate this. Note that a number will appear after each solder instruction. This number indicates the number of wires that are supposed to be connected to the terminal in point before it is soldered. For example, if the instruction reads, "Connect a wire to lug 1 (S-2)," it will be understood that there will be two wires connected to the terminal at the time it is soldered.

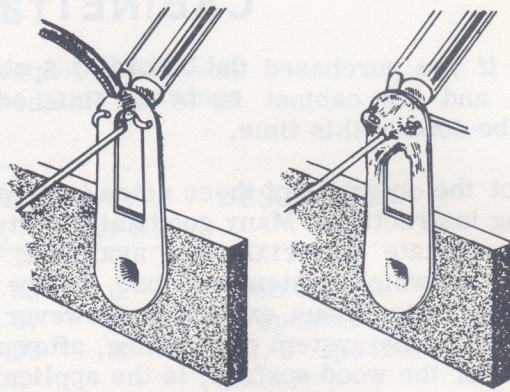

ROSIN CORE SOLDER HAS BEEN SUPPLIED WITH THIS KIT. THIS TYPE OF SOLDER MUST BE USED FOR ALL SOLDERING IN THIS KIT. ALL GUARANTEES ARE VOIDED AND WE WILL NOT REPAIR OR SERVICE EQUIPMENT IN WHICH ACID CORE SOLDER OR PASTE FLUXES HAVE BEEN USED. IF ADDITIONAL SOLDER IS NEEDED, BE SURE TO PURCHASE ROSIN CORE (60:40 or 50:50 TIN-LEAD CONTENT) RADIO TYPE SOLDER.

STEP-BY-STEP PROCEDURE

The following instructions are presented in a logical step-by-step sequence to enable you to complete your kit with the least possible confusion. Be sure to read each step all the way through before beginning the specified operation. Also read several steps ahead of the actual step being performed. This will familiarize you with the relationship of the subsequent operations. When the step is completed, check it off in the space provided. This is particularly important as it may prevent errors or omissions, es-

pecially if your work is interrupted. Some kit builders have also found it helpful to mark each part in colored pencil on the Pictorial as it is added.

In general, the illustrations in this manual correspond to the actual configuration of the kit; however, in some instances the illustrations may be slightly distorted to facilitate clearly showing all of the parts.

STEP-BY-STEP ASSEMBLY

The magnets used in the speakers create a strong magnetic field in the area around them. Keep them away from loose metal objects and tools. We also suggest you remove your wrist

watch and place it at a safe distance from the work area to prevent possible damage by magnetism. Place a soft cloth on the work area to prevent damage to the speaker enclosure.

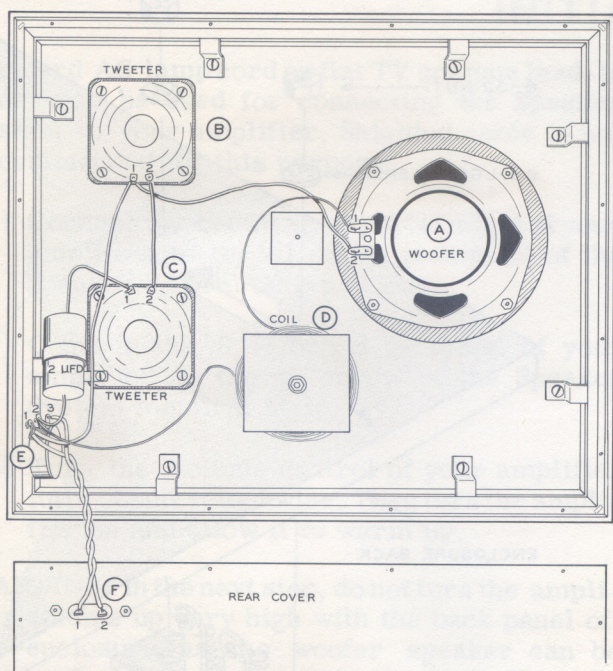

PICTORIAL 1

Refer to Pictorial 1 for the following steps.

- (✓) Remove the screws that hold the back panel and remove the back panel from the speaker enclosure. Mounting screws for the back panel will be found in an envelope fastened inside the enclosure.

NOTE: Be very careful to avoid puncturing or otherwise damaging the cones when mounting the speakers. Tighten the nuts or screws evenly to prevent warping the speaker frames.

- (✓) Mount the 5-1/2" woofer speaker on the four screws at cutout A in the speaker enclosure. Position the speaker as shown. Use #6 lockwashers and 6-32 nuts.
- (✓) Mount a 3" tweeter speaker at cutout B. Position the speaker lugs as shown. Use #6 x 3/8" sheet metal screws.
- (✓) Mount the other 3" tweeter speaker and the 2 μ fd capacitor at cutout C. Position the lugs and capacitor as shown. Use #6 x 3/8" sheet metal screws.
- (✓) Remove the square wood block from the screw at D and place the coil over the round wood block. Position the coil leads as shown.

- (✓) Replace the square wood block on the 6-32 screw and secure the coil, using the #6 flat washer and 6-32 nut removed in the previous step.
- (✓) Referring to Detail 1A, mount the Volume control at E, using a control lockwasher, control flat washer, and control nut. Position the control lugs as shown in Pictorial 1.
- (✓) Install the knob on the Volume control shaft. Push the knob onto the shaft until it just clears the surface of the enclosure.

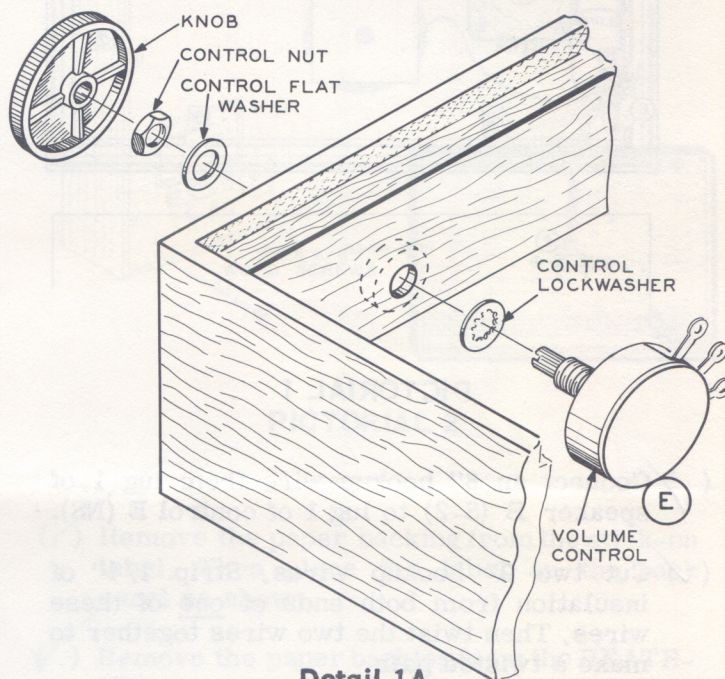

Detail 1A

- (✓) Connect a 2-1/2" hookup wire from lug 2 of speaker B (S-1) to lug 2 of speaker C (S-1).
- (✓) Connect one lead of the 2 μ fd capacitor to lug 1 of speaker C (S-1).
- (✓) Connect the other capacitor lead to lug 2 of control E (NS).
- (✓) Connect a 7" hookup wire from lug 2 of speaker A (S-1) to lug 1 of speaker B (NS).
- (✓) Connect the coil lead nearest to the front of the enclosure to lug 2 of control E (S-2).
- (✓) Connect the other coil lead to lug 1 of speaker A (S-1). Position the coil leads away from the front of the enclosure to prevent mechanical vibration.

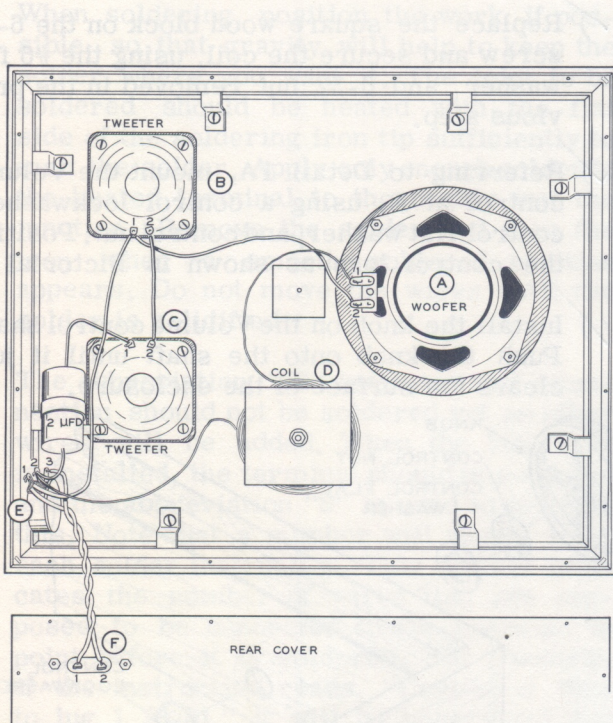

PICTORIAL 1

- (✓) Connect an 8" hookup wire from lug 1 of speaker B (S-2) to lug 1 of control E (NS).
- (✓) Cut two 9" hookup wires. Strip 1/4" of insulation from both ends of one of these wires. Then twist the two wires together to make a twisted pair.
- (✓) Connect the stripped wire at one end of the twisted pair to lug 1 of control E (S-2).
- (✓) Strip 1/4" of insulation from the other wire at this same end of the twisted pair and connect it to lug 3 of control E (S-1).
- (✓) Refer to Detail 1B and install the 2-lug terminal strip on the back panel at F. Use 6-32 x 1/2" screws, #6 lockwashers, and 6-32 nuts. Position the lugs as shown.

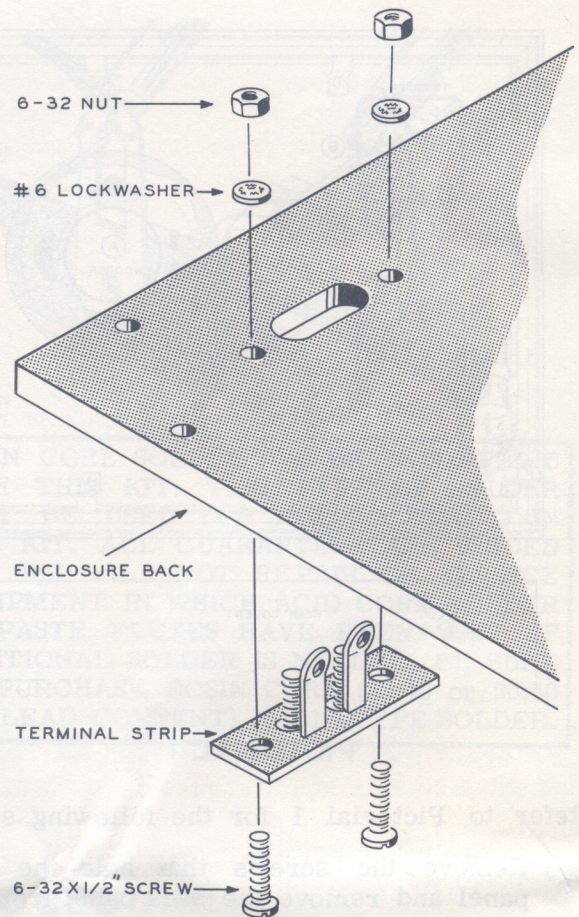

Detail 1B

- (✓) Connect the stripped wire at the free end of the twisted pair to lug 1 of terminal strip F on the enclosure back panel (S-1).
- (✓) Strip 1/4" of insulation from the remaining wire of the twisted pair and connect it to lug 2 of terminal strip F on the enclosure back panel (S-1).

This completes the wiring of the Speaker System.

INITIAL TEST

Standard AC lamp cord or flat TV antenna lead-in wire may be used for connecting the Speaker System to your amplifier. Shielded cable is not recommended for this purpose.

- (✓) Connect the common output terminal of your amplifier to the #1 screw (common) of the Speaker System terminal strip.
- (✓) Connect the 8 Ω output terminal of your amplifier to the #2 screw of the Speaker System terminal strip.
- (✓) Turn the Volume control of your amplifier fully counterclockwise. Then turn the amplifier on and allow it to warm up.

WARNING: In the next step, do not turn the amplifier volume up very high with the back panel off the enclosure as the woofer speaker can be damaged when operating in this "unloaded" condition.

- (✓) Turn the Speaker System Volume control to its full clockwise position. Then very slowly, advance the amplifier Volume control until program material is heard. This Speaker System requires very little audio power to produce a normal listening level.
- (✓) Turn the Speaker System Volume control counterclockwise. The volume should decrease.

Refer to Pictorial 2 for the following steps.

- (✓) If the Speaker System functions normally, mount the back panel on the enclosure, using the wood screws in the envelope which was attached inside the enclosure. If the Speaker System does not seem to operate properly, refer to the In Case Of Difficulty section of the Manual.

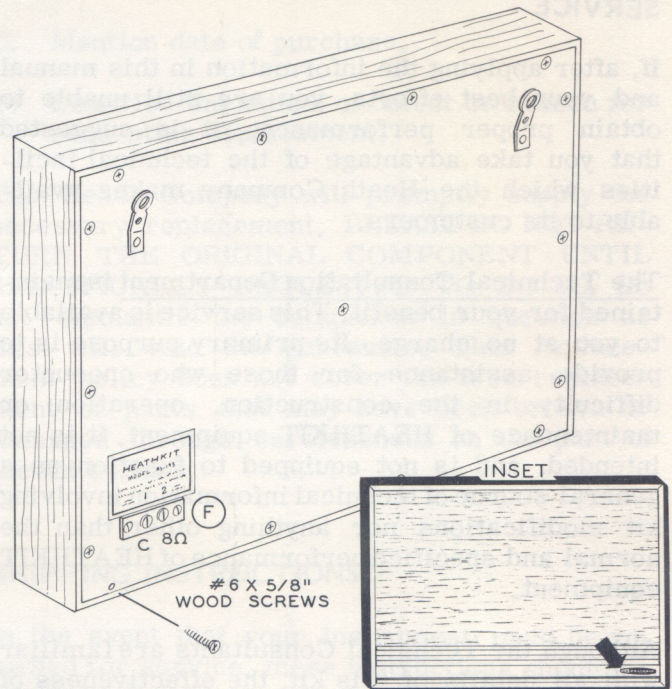

PICTORIAL 2

- (✓) Remove the paper backing from the stick-on label. Then place the label on the back panel as shown.
- (✓) Remove the paper backing from the HEATHKIT nameplate and secure the nameplate to the front of the cabinet as shown in the inset on Pictorial 2.

The Speaker System is now ready to be put into operation. It should be operated from an 8 Ω amplifier output, but will function satisfactorily from either a 4 Ω or 16 Ω output. If you wish, the Speaker System may be wall mounted, using the hangers on the back panel.

IN CASE OF DIFFICULTY

If difficulty was experienced during the Initial Test of the Speaker System, proceed as outlined below:

1. Check all connections of the Speaker System wiring and double check the soldered connections.
2. Check the wiring carefully against Pictorial 1 and the wiring steps.
3. Check the connections at the amplifier to make sure they are not shorted together, or to the amplifier chassis.

SERVICE INFORMATION

SERVICE

If, after applying the information in this manual and your best efforts, you are still unable to obtain proper performance, it is suggested that you take advantage of the technical facilities which the Heath Company makes available to its customers.

The Technical Consultation Department is maintained for your benefit. This service is available to you at no charge. Its primary purpose is to provide assistance for those who encounter difficulty in the construction, operation or maintenance of HEATHKIT equipment. It is not intended, and is not equipped to function as a general source of technical information involving kit modifications nor anything other than the normal and specified performance of HEATHKIT equipment.

Although the Technical Consultants are familiar with all details of this kit, the effectiveness of their advice will depend entirely upon the amount and the accuracy of the information furnished by you. In a sense, YOU MUST QUALIFY for GOOD technical advice by helping the consultants to help you. Please use this outline:

1. Before writing, fully investigate each of the hints and suggestions listed in this manual under In Case Of Difficulty. Possibly it will not be necessary to write.
2. When writing, clearly describe the nature of the trouble and mention all associated equipment. Specifically report operating procedures, connections to other units and anything else that might help to isolate the cause of trouble.
3. Report fully on the results obtained when testing the unit initially and when following the suggestions under In Case Of Difficulty. Be as specific as possible.
4. Identify the kit model number and date of purchase, if available. Also mention the date of the kit assembly manual. (Date at bottom of Page 1.)
5. Print or type your name and address, preferably in two places on the letter.

With the preceding information, the consultant will know exactly what kit you have, what you would like it to do for you and the difficulty you wish to correct. The date of purchase tells him whether or not engineering changes have been made since it was shipped to you. He will know what you have done in an effort to locate the cause of trouble and, thereby, avoid repetitious suggestions. In short, he will devote full time to the problem at hand, and through his familiarity with the kit, plus your accurate report, he will be able to give you a complete and helpful answer. If replacement parts are required, they will be shipped to you, subject to the terms of the Warranty.

The Factory Service facilities are also available to you, in case you are not familiar enough with electronics to provide our consultants with sufficient information on which to base a diagnosis of your difficulty, or in the event that you prefer to have the difficulty corrected in this manner. You may return the completed equipment to the Heath Company for inspection and necessary repairs and adjustments. You will be charged a minimal service fee, plus the price of any additional parts or material required. However, if the completed kit is returned within the Warranty period, parts charges will be governed by the terms of the Warranty. State the date of purchase, if possible.

Local Service by Authorized HEATHKIT Service Centers is also available in some areas and often will be your fastest, most efficient method of obtaining service for your HEATHKIT equipment. Although charges for local service are generally somewhat higher than for factory service, the amount of increase is usually offset by the transportation charge you would pay if you elected to return your kit to the Heath Company.

HEATHKIT Service Centers will honor the regular 90 day HEATHKIT Parts Warranty on all kits, whether purchased through a dealer or directly from Heath Company; however, it will be necessary that you verify the purchase date of your kit.

Under the conditions specified in the Warranty, replacement parts are supplied without charge; however, if the Service Center assists you in locating a defective part (or parts) in your kit, or installs a replacement part for you, you may be charged for this service.

HEATHKIT equipment purchased locally and returned to Heath Company for service must be accompanied by your copy of the dated sales receipt from your authorized HEATHKIT dealer in order to be eligible for parts replacement under the terms of the Warranty.

THIS SERVICE POLICY APPLIES ONLY TO COMPLETED EQUIPMENT CONSTRUCTED IN ACCORDANCE WITH THE INSTRUCTIONS AS STATED IN THE MANUAL. Equipment that has been modified in design will not be accepted for repair. If there is evidence of acid core solder or paste fluxes, the equipment will be returned NOT repaired.

For information regarding modification of HEATHKIT equipment for special applications, it is suggested that you refer to any one or more of the many publications that are available on all phases of electronics. They can be obtained at or through your local library, as well as at most electronic equipment stores. Although the Heath Company sincerely welcomes all comments and suggestions, it would be impossible to design, test, evaluate and assume responsibility for proposed circuit changes for special purposes. Therefore, such modifications must be made at the discretion of the kit builder, using information available from sources other than the Heath Company.

REPLACEMENTS

Material supplied with HEATHKIT products has been carefully selected to meet design requirements and ordinarily will fulfill its function without difficulty. Occasionally, improper operation can be traced to a faulty component. Should inspection reveal the necessity for replacement, write to the Heath Company and supply all of the following information.

- A. Thoroughly identify the part in question by using the part number and description found in the manual Parts List.

- B. Identify the type and model number of kit in which it is used.
- C. Mention date of purchase.
- D. Describe the nature of defect or reason for requesting replacement.

The Heath Company will promptly supply the necessary replacement. PLEASE DO NOT RETURN THE ORIGINAL COMPONENT UNTIL SPECIFICALLY REQUESTED TO DO SO. Do not dismantle the component in question as this will void the guarantee. This replacement policy does not cover the free replacement of parts that may have been broken or damaged through carelessness on the part of the kit builder.

SHIPPING INSTRUCTIONS

In the event that your instrument must be returned for service, these instructions should be carefully followed.

Wrap the equipment in heavy paper, exercising care to prevent damage. Place the wrapped equipment in a stout carton of such size that at least three inches of shredded paper, excelsior, or other resilient packing material can be placed between all sides of the wrapped equipment and the carton. Close and seal the carton with gummed paper tape, or alternately, tie securely with stout cord. Clearly print the address on the carton as follows:

To: HEATH COMPANY
Benton Harbor, Michigan

ATTACH A LETTER TO THE OUTSIDE OF THE CARTON BEARING YOUR NAME, COMPLETE ADDRESS, DATE OF PURCHASE, AND A BRIEF DESCRIPTION OF THE DIFFICULTY ENCOUNTERED. Also, include your name and return address on the outside of the carton. Preferably affix one or more "Fragile" or "Handle With Care" labels to the carton, or otherwise so mark with a crayon of bright color. Ship by insured parcel post or prepaid express; note that a carrier cannot be held responsible for damage in transit if, in HIS OPINION, the article is inadequately packed for shipment.

WARRANTY

Heath Company warrants that for a period of three months from the date of shipment, all Heathkit parts shall be free of defects in materials and workmanship under normal use and service and that in fulfillment of any breach of such warranty, Heath Company shall replace such defective parts upon the return of the same to its factory. The foregoing warranty shall apply only to the original buyer, and is and shall be in lieu of all other warranties, whether express or implied and of all other obligations or liabilities on the part of Heath Company and in no event shall Heath Company be liable for any anticipated profits, consequential damages, loss of time or other losses incurred by the buyer in connection with the purchase, assembly or operation of Heathkits or components thereof. No replacement shall be made of parts damaged by the buyer in the course of handling or assembling Heathkit equipment.

NOTE: The foregoing warranty is completely void and we will not replace, repair or service instruments or parts thereof in which acid core solder or paste fluxes have been used.











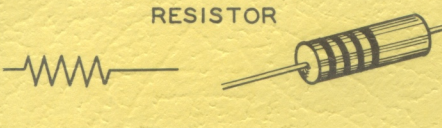

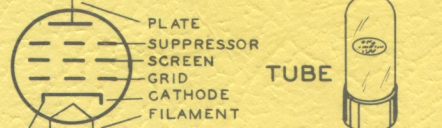

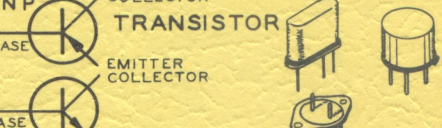

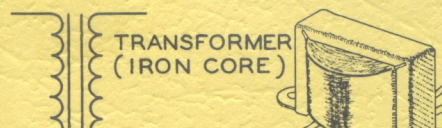
HEATH COMPANY

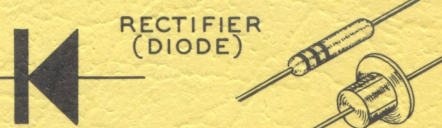
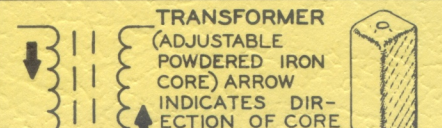
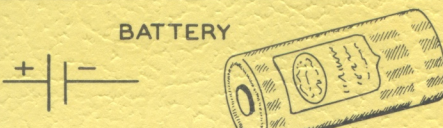
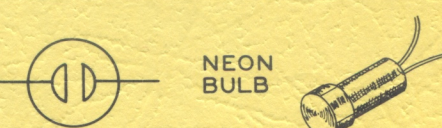
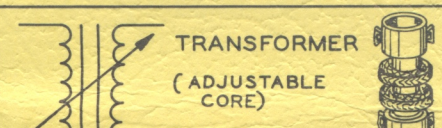
Under the conditions specified in the manual parts are supplied without charge; however, the Service Center assists you in locating a defective part (or parts) in your kit or in a replacement part for your kit. HEATHKIT equipment purchased directly from the Heath Company for service will promptly be replaced; necessary replacement. PLEASE DO NOT RETURN THE ORIGINAL COMPONENT TO US. Under the conditions specified in the manual parts are supplied without charge; however, the Service Center assists you in locating a defective part (or parts) in your kit or in a replacement part for your kit. HEATHKIT equipment purchased directly from the Heath Company for service will promptly be replaced; necessary replacement. PLEASE DO NOT RETURN THE ORIGINAL COMPONENT TO US.

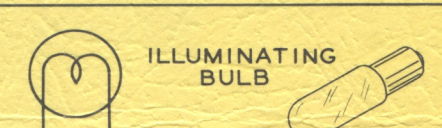
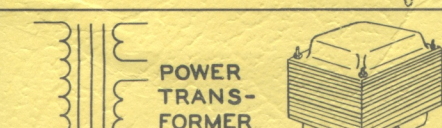
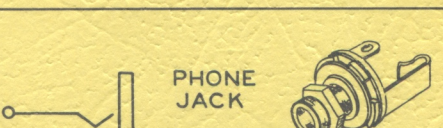
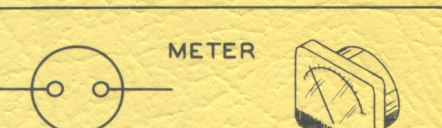
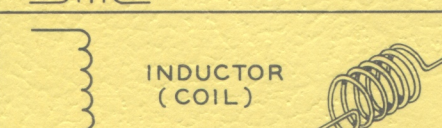
TYPICAL COMPONENT TYPES

This chart is a guide to commonly used types of electronic components. The symbols and related illustrations

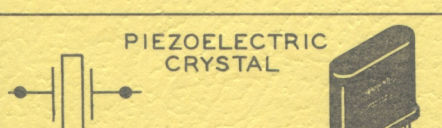
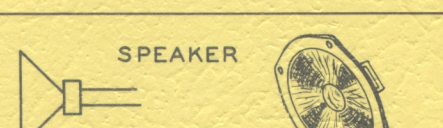
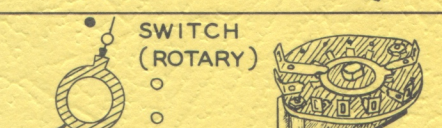
should prove helpful in identifying most parts and reading the schematic diagrams.

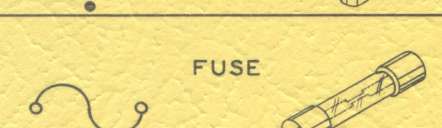
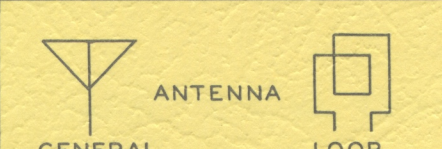
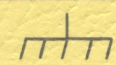
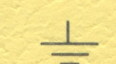
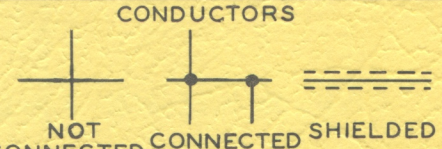
<p style="text-align: center;">RESISTOR</p> 	<p style="text-align: center;">CAPACITOR</p> 	<p style="text-align: center;">TUBE</p>  <p>PLATE SUPPRESSOR SCREEN GRID CATHODE FILAMENT</p>
<p style="text-align: center;">POTENTIOMETER (CONTROL)</p> 	<p style="text-align: center;">ELECTROLYTIC CAPACITOR</p> 	<p style="text-align: center;">PNP TRANSISTOR</p>  <p>COLLECTOR BASE EMITTER</p> <p style="text-align: center;">NPN TRANSISTOR</p>  <p>BASE EMITTER COLLECTOR</p>
<p style="text-align: center;">TRANSFORMER (IRON CORE)</p> 	<p style="text-align: center;">VARIABLE CAPACITOR</p> 	<p style="text-align: center;">RECTIFIER (DIODE)</p> 
<p style="text-align: center;">TRANSFORMER (ADJUSTABLE POWDERED IRON CORE) ARROW INDICATES DIR- ECTION OF CORE MOVEMENT TO INCREASE INDUCTANCE</p> 	<p style="text-align: center;">BATTERY</p> 	<p style="text-align: center;">NEON BULB</p> 
<p style="text-align: center;">TRANSFORMER (ADJUSTABLE CORE)</p> 	<p style="text-align: center;">PHONO JACK</p> 	<p style="text-align: center;">ILLUMINATING BULB</p> 
<p style="text-align: center;">POWER TRANS- FORMER</p> 	<p style="text-align: center;">PHONE JACK</p> 	<p style="text-align: center;">METER</p> 
<p style="text-align: center;">INDUCTOR (COIL)</p> 	<p style="text-align: center;">RECEPTACLE</p> 	<p style="text-align: center;">SPST SWITCH (TOGGLE)</p>  <p style="text-align: center;">DPDT</p> 
<p style="text-align: center;">PIEZOELECTRIC CRYSTAL</p> 	<p style="text-align: center;">SPEAKER</p> 	<p style="text-align: center;">SWITCH (ROTARY)</p> 
<p style="text-align: center;">BINDING POST</p> 	<p style="text-align: center;">MICROPHONE</p> 	<p style="text-align: center;">FUSE</p> 
<p style="text-align: center;">ANTENNA</p>  <p>GENERAL LOOP</p>	<p style="text-align: center;">EARTH GROUND</p>  <p style="text-align: center;">CHASSIS GROUND</p> 	<p style="text-align: center;">CONDUCTORS</p>  <p>NOT CONNECTED CONNECTED SHIELDED</p>

HEATH COMPANY
BENTON HARBOR, MICHIGAN

 *a subsidiary of*
DAYSTROM, INCORPORATED

THE WORLD'S FINEST ELECTRONIC EQUIPMENT IN KIT FORM