

ASSEMBLING AND  
USING YOUR

*Heathkit*

CONDENSER CHECKER  
MODEL C-1



THE HEATH COMPANY  
BENTON HARBOR, MICH.

PRICE \$1.00

---

---

## USEFUL INFORMATION FOR KIT BUILDERS

Resistors are identified by a color code used in several bands around the resistors. There are two general types of resistors. One, the uninsulated type, has the connecting wires bound around the ends. The other, the insulated type, has the wire connected internally and coming out the ends. The resistance code uses three bands or colors, while a fourth, usually silver or gold, indicates the tolerance. The colors are arranged so that the first two indicate the first two figures of the resistance, while the third indicates the number of digits (zeros or multiplier) which follow the first two figures. On un-insulated resistors, the body is the first figure, the end color the second figure, and the dot the number of digits. On insulated resistors, the band nearest the end is the first figure, the next band is the second figure and the third band the number of digits.

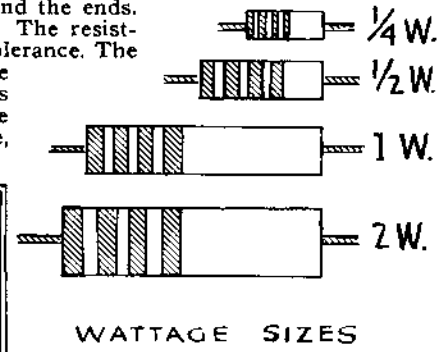

**WATTAGE.** Resistors are rated as to wattage (power dissipation) according to size. The chart shows approximate sizes which vary with manufacturers. To determine wattage size necessary multiply current through resistor in amperes by voltage drop across resistors in volts. Example — A plate loading resistor for a tube drawing 10 milliamperes (.01 Amperes) has a voltage on one side of 300 volts and on the other side 200 volts, giving a drop of 100 volts. Therefore 100 volts × .01A. = 1 Watt.

A higher wattage resistor can always be substituted for smaller size.

| Uninsulated<br>Insulated | Body Color<br>First Ring | End Color<br>Second Ring | Dot Color<br>Third Ring |
|--------------------------|--------------------------|--------------------------|-------------------------|
| Color                    | First Figure             | Second Figure            | Number of Digits        |
| Black                    | 0                        | 0                        | None                    |
| Brown                    | 1                        | 1                        | 0                       |
| Red                      | 2                        | 2                        | 00                      |
| Orange                   | 3                        | 3                        | 000                     |
| Yellow                   | 4                        | 4                        | 0,000                   |
| Green                    | 5                        | 5                        | 00,000                  |
| Blue                     | 6                        | 6                        | 000,000                 |
| Violet                   | 7                        | 7                        | 0,000,000               |
| Grey                     | 8                        | 8                        | 00,000,000              |
| White                    | 9                        | 9                        | 000,000,000             |

### UNINSULATED TYPE

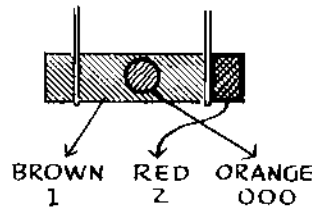

### Examples

### INSULATED TYPE Fourth Band for Tolerance

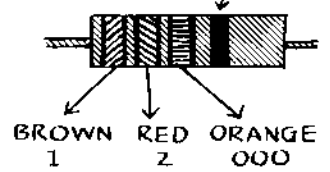

## Some Popular Sizes of Resistors

| RESISTANCE IN OHMS | BODY OR FIRST BAND | END OR SECOND BAND | DOT OR THIRD BAND |
|--------------------|--------------------|--------------------|-------------------|
| 50                 | Green              | Black              | Black             |
| 250                | Red                | Green              | Brown             |
| 1500               | Brown              | Green              | Red               |
| 30,000             | Orange             | Black              | Orange            |
| 220,000            | Red                | Red                | Yellow            |
| 1 Megohm           | Brown              | Black              | Green             |

The fourth ring or other end may be silver (10% tolerance) or gold (5% tolerance) or it may be omitted entirely which indicates 20% tolerance.

## Condenser Code

Condensers use the same code as resistors and are read in micromicrofarads.

If there is one row of dots, they are read in direction of arrow or if manufacturer's name appears in the same direction as name. If two rows of dots appear, it can either be of two different codes: The RMA or the AWS (American War Standard). In the RMA, the top row of dots are the first three figures (carried to three figures), the bottom row are left to right the voltage rating, tolerance, and decimal multiplier.

In the AWS code, the top row of dots are the first three figures while the bottom row are, left to right, characteristic, tolerance, and decimal multiplier.

### Examples

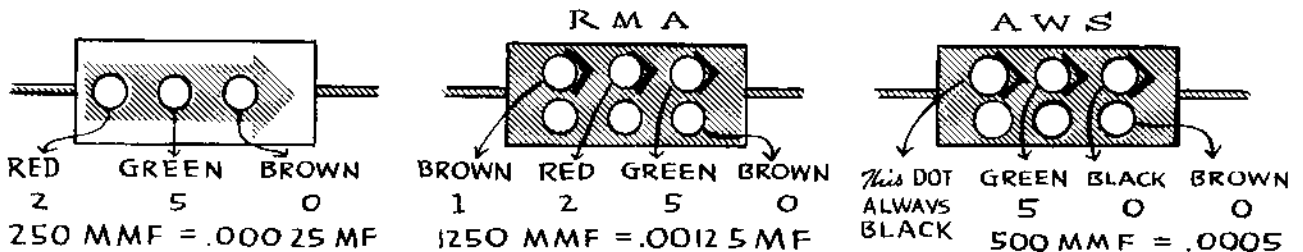

## Some Commonly Used Sizes of Condensers

| MMF.   | MF.    | FIRST DOT | SECOND DOT | THIRD DOT |
|--------|--------|-----------|------------|-----------|
| 10     | .00001 | Brown     | Black      | Black     |
| 50     | .00005 | Green     | Black      | Black     |
| 100    | .0001  | Brown     | Black      | Brown     |
| 250    | .00025 | Red       | Green      | Brown     |
| 500    | .0005  | Green     | Black      | Brown     |
| 1000   | .001   | Brown     | Black      | Red       |
| 3000   | .003   | Orange    | Black      | Red       |
| 10,000 | .01    | Brown     | Black      | Orange    |

The tolerance rating corresponds to the color code, i.e., red — 2%, green — 5%, etc.

The voltage rating corresponds to the code multiplied by 100. Example: Orange dot — 300 volt rating; Blue — 600 volt rating.

## ASSEMBLING THE HEATHKIT MODEL C-1 CONDENSER CHECKER

The Heathkit Condenser Checker utilizes the most accurate method of measuring capacitance, the bridge method. It consists of an AC bridge, using a wire wound potentiometer as the variable arms of bridge. Several sizes of capacity standards can be switched into the circuit to cover the various ranges, and additional resistance is switched in series with the variable resistance for the extended range. A magic eye tube is used as an indicator for the bridge circuit. The null is indicated by the largest opening in the eye tube. Power factor of electrolytic condensers is indicated by a variable resistance in series with the standard condenser. After the null is established with the main control, the power factor adjustment is made by adjusting it to the widest clearest opening of the eye tube. The power factor is then read on the calibrated scale. Leakage of condensers is checked by a neon bulb which indicates current through the condenser. After the initial charge of the condenser under test, the interval between flashes gives an excellent indication of the leakage.

The selector switch allows a choice over a 20 to 500 volt range for checking leakage.

The construction of this instrument is not difficult, but as this is a delicate test instrument which will be useful for many years, it deserves the best of careful workmanship. Poor construction will result in an inaccurate instrument.

Thoroughly familiarize yourself with the layout, schematic and pictorial diagram. Do not rush the construction. Make a good mechanical joint of each connection and then solder it with the best quality of rosin core radio type solder. Hold each joint rigid until cool and then test by attempting to pull the joint loose. Most difficulty in construction results from improper wiring and poor soldered connections. The resistances in this circuit are ten or more megohms and poor solder connections will greatly change or affect the accuracy.

Begin by checking the parts against the parts list. Identify each part. This will avoid throwing away any small parts in the packing. Use the charts to identify resistors and condensers.

From time to time, small changes in parts will be made by the Heath Company. All parts supplied will work just as well as the part for which it was substituted. 47,000 ohm resistors (which is the new radio manufacturers rating for 50,000 ohms) may be substituted for 50,000 ohms or a one watt resistor may be substituted for  $\frac{1}{2}$  watt, etc. All substitutions will be of equal or better quality than the original and will be made in order that a minimum delay will occur in filling your order.

The newer types of insulated resistors have a higher wattage rating. The  $\frac{1}{4}$  watt size is now rated as  $\frac{1}{2}$  watt and these are used in this kit. Bolts and nuts are counted mechanically, and if a few are missing secure locally.

Resistors and potentiometers have a tolerance rating of plus or minus 20% unless otherwise stated. Therefore, a one megohm unit may test between 800,000 and 1,200,000 ohms. The Heathkit circuits are designed to accommodate these variations.

The socket connections are numbered on the bottom of the sockets. They are fastened into the chassis with the wavy metal rings which are forced over the bottom of the socket and into the grooves in the socket. The end of the ring can be held in the groove and the rest of the ring forced over and into the groove with a screw driver.

Begin the construction by mounting the sockets. The keyways point toward the bottom of the cabinet. Mount the power transformer with the insulated terminal strip under the same machine screw. Use a solder lug under one of the mounting screws for ground connection. The chassis may be wired before mounting it on the panel. The spare terminals on the tube sockets are used as tie points for mounting condensers and resistors. The two 8 MFD electrolytic condensers are mounted in this manner. As Contact One of the 12A6 is grounded, the negative end of one condenser is connected here, the other end going to Contact Four of the 1629 eye tube. Use spaghetti (insulated sleeving) over the bare condenser lead. The negative lead of the other 8 MFD condenser connects to contact 4 of the 1629, while the positive lead goes to the high voltage contact of the 12A6 rectifier tube, pin 3. This completes the filter circuit.

The 30,000 ohm voltage divider resistors are mounted directly on the switch C20. The coupling condenser T13 uses contact 1 of the 1629 as tie point.

The panel is assembled before attaching to the chassis.

The location and mounting of the parts should follow the photo print in order that the panel markings will be correct. Selector switch C20 should be wired before mounting on the panel.

The condensers C14, C15 and C16 are selected to special tolerances to be used as standards. C15 is selected by using two condensers to provide the correct rating. These are sent with the leads twisted together, and care should be exercised not to separate or mislay this combination.

The 2 MFD C14 condenser consists of a dual 1 MFD condenser in one metal can. The two connections on each end of the can should be connected together to give 2 MFD.

The neon bulb is mounted in the larger rubber grommet. This is placed in the hole in the panel, the bulb placed in the socket and then pressed into the grommet, extending through  $\frac{1}{4}$  inch. Use the terminal strip as a tie point.

After all panel wiring is completed, the chassis is assembled to it, and the connections made. The line cord is installed with a knot in it to prevent strain on the solder connections. Make up the test leads with the banana plugs on one end and alligator clips on the other. The red or positive banana jack is the center connection. The main control is attached with the ends of the scale as the limits of rotation in either direction.

The power factor pointer should be set with the pointer reading "paper and mica" when the switch is snapped off, and "O Elec." with the switch snapped on. The maximum rotation should be exactly on 50%. The selector switch is mounted with the flat side of the shaft directly opposite the correct reading in order that with the pointer knob set screw against the flat the pointer will read correctly.

Upon completion of the wiring, recheck all connections.

A suggested way is to follow each connection in the instrument and mark it on the circuit diagram with a colored pencil. In this manner, any connections overlooked or incorrect will be disclosed. Check the banana jacks for connections and panel reading so as not to reverse the resistance and capacity connections.

If wiring is in order, plug into 110V 60 cycle AC.

Turn on and allow one minute to heat tubes. The 1629 eye tube will gradually become a brilliant green. Plug in the test leads and try checking a condenser setting the selector switch to the proper range. The instrument is now ready to use.

A resistance measuring bridge is also included. This is intended primarily as a rapid convenient means of establishing the resistance of unknown resistors between 50 ohms and 5 megohms. The inner scale is used for this purpose, and the test leads are plugged into the jacks marked RES. The main control is adjusted for maximum opening of the eye.

Always make certain that all controls are set properly for type of condenser being checked. When checking paper or mica condensers, set selector to proper range and power factor switch to "paper and mica."

Electrolytic condensers should be checked with the power factor switch set on "Elec."

The power factor adjustment operates only on the .1 to 50 MFD range, and the extended range.

To check the leakage of any condenser, set the power factor control switch to proper setting, connect test leads to condenser, observing polarity (red to positive) and set the selector switch to the rated voltage (under 200 Volts use the 20 Volt position.) The neon bulb will glow steadily while the condenser is charged. The condenser is satisfactory if glow stops within a short period or if it flashes not more than once per second. On electrolytics, a period of several minutes may be required to charge the unit.

Fast flashing or steady glow indicate shorted condenser.

A condenser which will not balance on any of the ranges but allows the eye to open on any range at the low end is open, while one which allows the eye to open on any range at the high or top of the scales is shorted.

This may be noted by leaving the leads disconnected and rotating the control and shorting the leads and rotating the dial.

**CAUTION:** Never leave the lead shorted together or connected to a shorted condenser as the prolonged drain may damage the instrument.

The position when selector switch is pointing directly down should be used for connecting and disconnecting the test leads. In this position, the center or positive terminal is disconnected.

Never change the test leads while the selector switch is in leakage, as a severe shock will result.

Note that there is overlap of each range, and if difficulty is experienced obtaining an accurate reading in the high end of each range, the reading can be obtained in the lower end of the next higher range.

Tolerances of condensers are very broad, and many are rated as high as plus 100% to minus 50%. In most applications, the capacity may vary this amount without harm. The power factor of electrolytics is not critical and any power factor from 0-50% may be used in filtering power supplies where no bypassing of RF is required. The actual filtering of a condenser reduces with increasing power factor.

The standard condensers supplied with this kit are checked within plus or minus 2% for the lower ranges, and plus or minus 5% for the higher ranges. This accuracy can be maintained if the tuning knob is set correctly. Normally setting the knob as outlined is sufficient, although for best accuracy it should be set with a precision standard. Where this is desired, the Heath Company will adjust any Heathkit checker and check it against General Radio 1% standards for a charge of \$3.00 plus transportation charges.

To change Microfarads in which the Heathkit condenser checker is calibrated to Micro microfarads (MF into MMF) multiply the readings obtained by 1,000,000. Therefore, .0002 MF is 200 MMF. (.0002 x 1,000,000 equals 200.)

If measuring extremely small condensers, it is recommended that they be inserted directly into the banana jacks or a special set of alligator clips mounting directly without leads be made up to avoid the error caused by the test lead.

#### IN CASE OF DIFFICULTY

1. Recheck entire wiring. Most cases of difficulty result from wrong or reversed connections.
2. Check the AC voltages from the transformer, yellow to yellow, 9 to 12V AC, green to green, 40 to 50V AC, red to red, 400 to 500V AC. From chassis to contact 8 of the 12A6 tube, 450-600V DC.
3. Check the banana jacks to be certain they are not shorting to the panel.
4. Check capacity in the resistance jacks to make certain the jacks are not wired in reverse.
5. Recheck the wiring of the selector switch, remembering that the diagram shows it as viewed from rear of cabinet. (Often having a friend check the wiring will divulge an error being consistently overlooked.)
6. If you are unable to obtain results, write the Heath Company, giving all possible information, such as voltages obtained, indications if any, and all other helpful information.
7. If desired, your instrument may be returned to the factory. The Heath Company will check and put it into operating condition for a charge of \$3.00 plus any parts or alterations required due to damaged or improper construction. Attach a tag giving your name and address and trouble experienced with the instrument. Pack carefully with plenty of padding over face of instrument. Mark "FRAGILE--DELICATE INSTRUMENT" and ship to us prepaid. Instrument will be returned charges collect.

Prices subject to change without notice. The Heath Company reserves the right to change the design of its instruments without incurring liability for equipment previously supplied.

HEATH COMPANY  
Benton Harbor, Michigan

## C1 CONDENSER CHECKER PARTS LIST

| Part No. | No. Parts Per Kit | Description                             | Part No. | No. Parts Per Kit | Description                                       |
|----------|-------------------|---|----------|-------------------|---|
| O17      | 1                 | 1 Megohm $\frac{1}{2}$ Watt Resistor    | O34      | 4                 | Rubber Feet                                       |
| C10      | 1                 | 10 Megohm $\frac{1}{4}$ Watt Resistor   | O79      | 1                 | Handle  |
| C11      | 2                 | 100,000 Ohm $\frac{1}{2}$ Watt Res. 5%  | S22      | 2                 | 6-32 x $\frac{1}{4}$ Nuts                         |
| V11      | 1                 | 200,000 Ohm $\frac{1}{4}$ Watt Resistor | C24      | 1                 | $\frac{7}{16}$ " Rubber Grommet                   |
| C12      | 1                 | 1,000 Ohm 1 Watt Resistor 5%            | V38      | 3                 | $\frac{5}{16}$ " Insulated Shoulder Washer (#630) |
| C13      | 6                 | 30,000 Ohm 1 Watt Resistor              | O28      | 3                 | $\frac{3}{8}$ " Control Washers (#741)            |
| C14      | 1                 | 2 MFD Bathtub Condenser                 | O33      | 3                 | $\frac{3}{8}$ " Control Nuts (#737)               |
| C15      | 1                 | .02 Cond. (Matched pair of .01)         | O33C     | 3                 | Lock Washers (#1220)                              |
| C16      | 1                 | 200 MMF Mica Condenser                  | O33D     | 8                 | #6 Self Tapping Panel Screws                      |
| O50      | 2                 | 8 MFD 475V Electrolytic Cond.           | O31      | 14                | 6-32 x $\frac{3}{8}$ " Machine Screws             |
| T13      | 1                 | .01 MFD Fixed Condenser                 | O32      | 12                | 6-32 Nuts   |
| C17      | 1                 | .5 MFD Tubular Condenser                | O37      | 1                 | Soldering Lug                                     |
| C18      | 1                 | 10,000 Ohm W.W. Control                 | O38      | 2                 | Insulated Terminal Strips                         |
| C19      | 1                 | 800 Ohm W.W. Control with SPDT Switch   | V44      | 2                 | Alligator Clips                                   |
| C20      | 1                 | 2 Pole 11 Pos. Rotary Switch            | SG22     | 1                 | NE51 Neon Bulb                                    |
| O94      | 1                 | SPST Slide Switch                       | C25      | 1                 | Neon Bulb Socket                                  |
| C38      | 1                 | Tuning Knob with Pointer (#4102B)       | O78      | 1                 | Line Cord   |
| O51      | 2                 | Pointer Knobs                           | C26      | 1                 | Roll Hookup Wire 8'                               |
| C21      | 1                 | 1629 Eye Tube                           | C35      | 1                 | Length Spaghetti 8"                               |
| K23      | 1                 | 12A6 Rectifier Tube                     | C27      | 1                 | Power Transformer (P125)                          |
| O54      | 2                 | Octal Sockets                           | C28      | 1                 | Panel   |
| O43      | 2                 | Octal Socket Rings                      | C29      | 1                 | Chassis   |
| V36      | 2                 | Black Banana Jacks                      | C30      | 2                 | Chassis End Brackets                              |
| V37      | 1                 | Red Banana Jack                         | T32      | 1                 | Cabinet   |
| V39      | 1                 | Black Banana Plug                       | O83      | 1                 | Introductory Sheet (F.O.)                         |
| V40      | 1                 | Red Banana Plug                         | C31      | 1                 | Set of Instructions                               |
| C22      | 1                 | Lgth. Black Test Lead Wire 1 ft.        | C32      | 1                 | Parts List  |
| C23      | 1                 | Lgth. Red Test Lead Wire 1 ft.          | C33      | 1                 | Schematic Print                                   |
| O35      | 1                 | $\frac{3}{8}$ " Rubber Grommet (#905)   | C34      | 1                 | Photo Print                                       |
| O30      | 2                 | 10-24 x $\frac{3}{8}$ " Handle Screws   |          |                   |   |

HEATH COMPANY  
Benton Harbor, Michigan

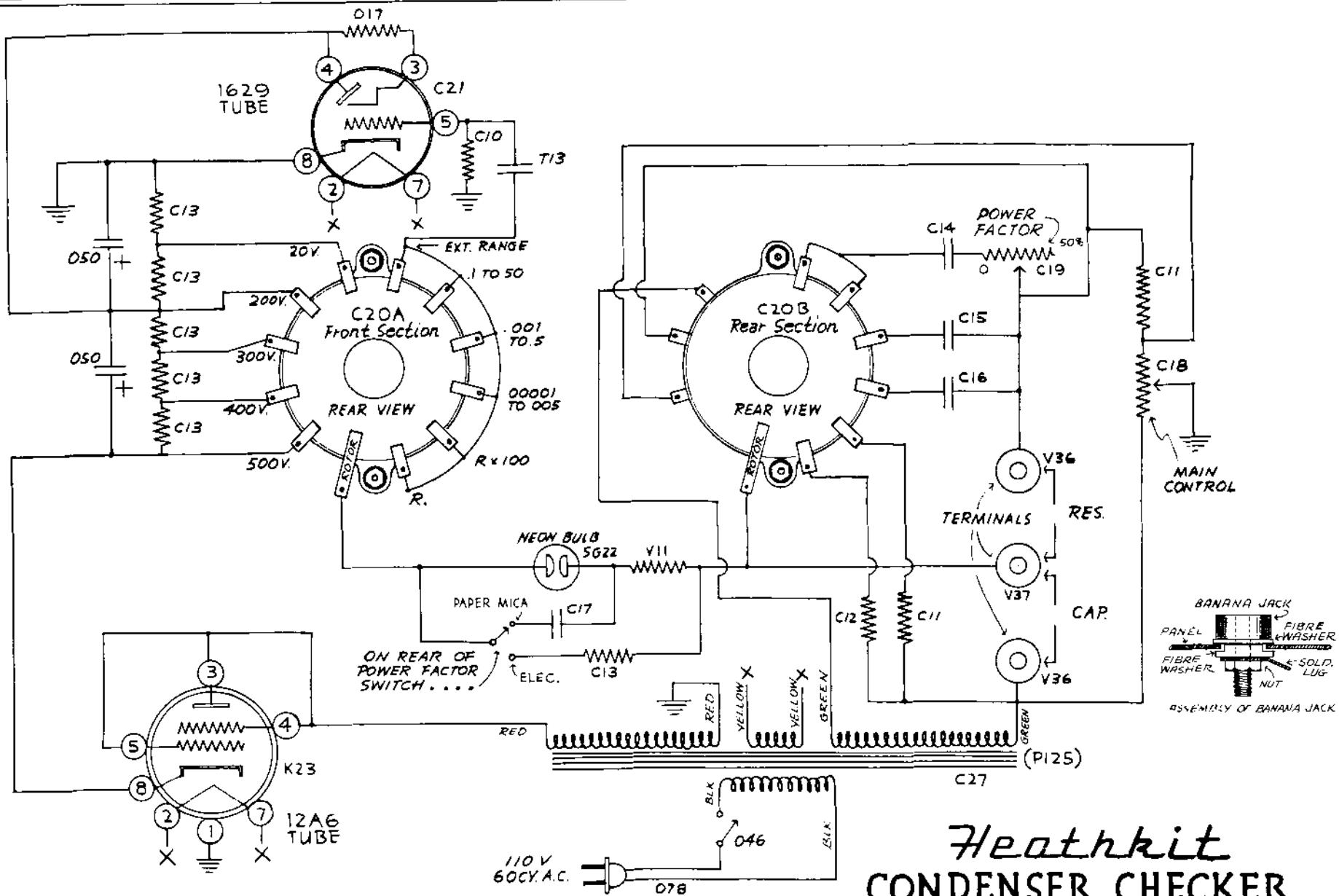

ALL FIGURES SHOWN ARE HEATH COMPANY PART NUMBERS AND ARE NOT VALUES OF PARTS . . . . .

CONNECT POINTS MARKED X ON TUBES TO POINTS MARKED X ON TRANSFORMER . . . . .

# Heathkit CONDENSER CHECKER

MODEL C-1 . . . . . JUNE 22, 1948

The HEATH COMPANY  
BENTON HARBOR, MICHIGAN

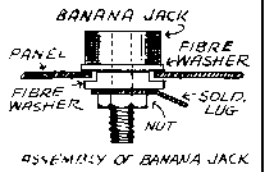



Heathkit CONDENSER CHECKER . . . MODEL C-1

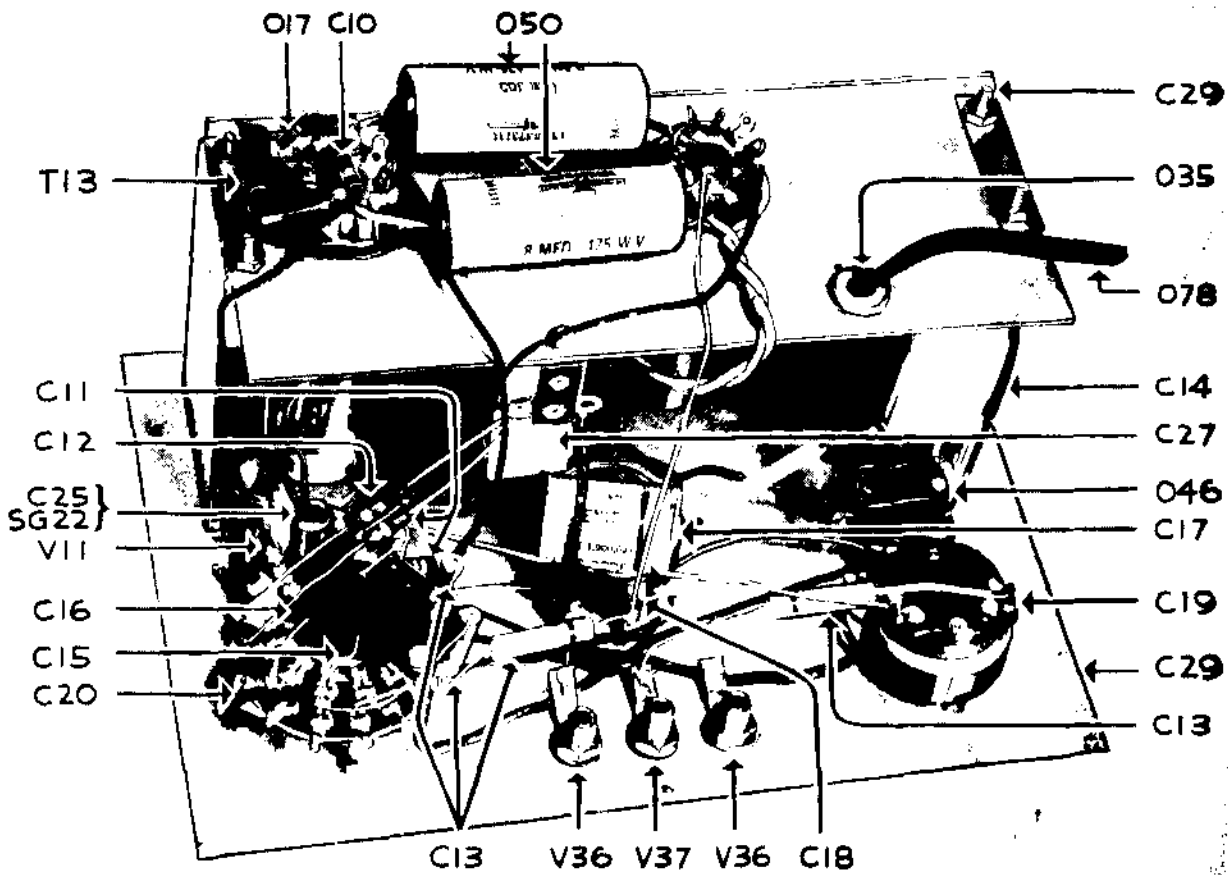

• • REAR VIEW • •

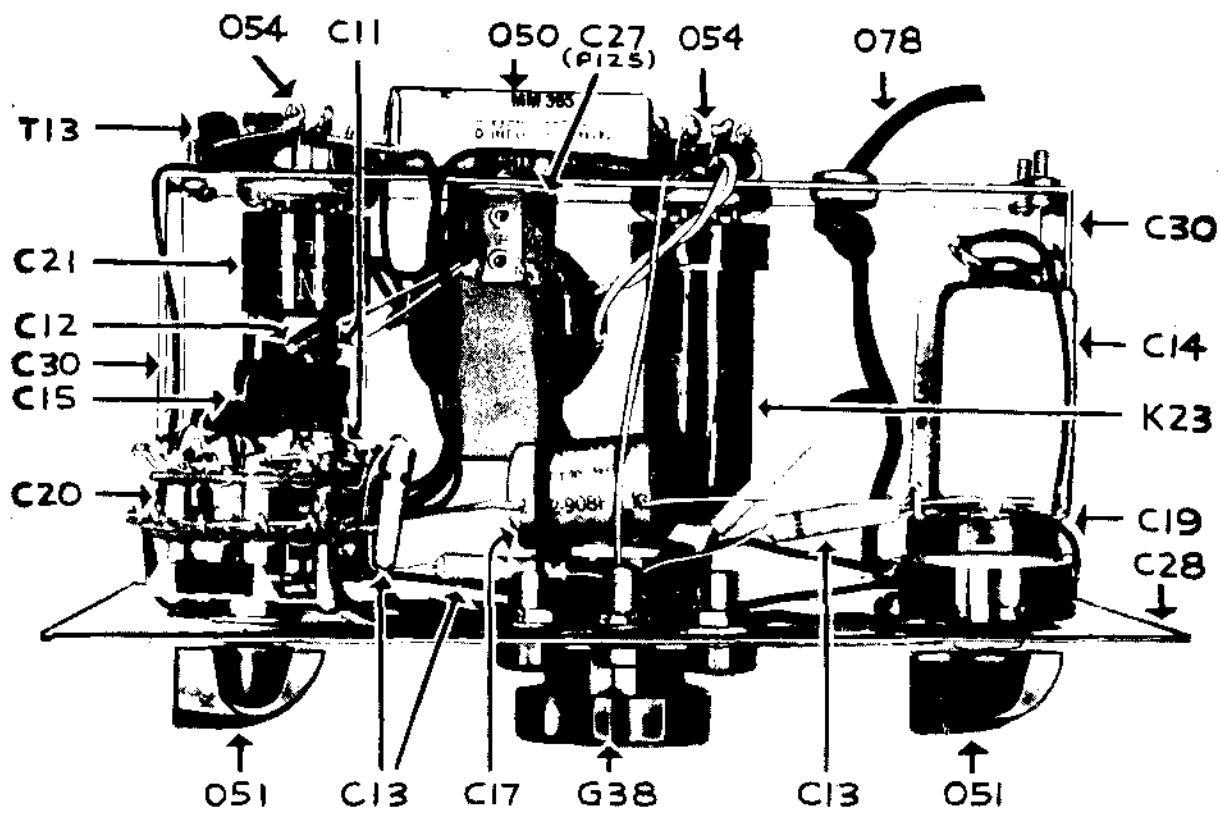

• • BOTTOM VIEW • •

JUNE 25, 1948  
No C 34 . . . .

THE HEATH COMPANY  
BENTON HARBOR, MICH.

# RMA Color Code on Transformers

## I.F. TRANSFORMERS

**Blue** — Plate Lead  
**Red** — B + Lead  
**Green** — Grid  
**Black** — Ground or AVC

If center tapped other grid is green and black striped.

## AUDIO TRANSFORMERS

**Blue** — Plate Lead  
**Red** — B + Lead  
**Brown** — Other Plate on Push Pull  
**Green** — Grid Lead  
**Black** — Ground Lead  
**Yellow** — Other Grid on Push Pull

## POWER TRANSFORMERS PRIMARY — BLACK

**High Voltage Plate — Red**  
 Center Tap Red and Yellow Striped

**Rectifier Filament — Yellow**  
 Center Tap Yellow and Blue

**Filament No. 1 — Green**  
 Center Tap Green and Yellow

**Filament No. 2 — Brown**  
 Center Tap — Brown and Yellow

**Filament No. 3 — Slate**  
 Center Tap — Slate and Yellow

## Soldering

The most important thing in good soldering is to heat the joint and allow the solder to flow into it. The solder should melt from contact with the joint rather than with the iron. Never use pastes or acids in radio work.

Use only rosin core solder. Never depend on the solder to hold a joint. Always make a firm connection with the wire before applying solder. To tin a soldering iron (soldering cannot be done with the bare copper) file the surface lightly while the iron is hot and then quickly apply a generous amount of rosin core solder while the filed surface is still bright. Wipe off excess solder with a cloth.

Tin all four sides of the tip in this manner.

























The terminals must be clean, and preferably tinned. On some terminals that are hard to solder to (nickel plated f.i.) it is desirable to pre-tin the surface before installation or connection. Clean (scrape or sandpaper) the surface, heat with iron and apply rosin core solder liberally. Wipe off or shake off excess solder.

## Recommended Tools

A good electric soldering iron (100 watt with small tip)  
 Long or needle nose pliers 6".  
 Diagonal or side cutting pliers (5" or 6").  
 An assortment of screw drivers flat and Phillips type.

File. Round and flat types.  
 Purchase quality tools and you will enjoy and use them many years.  
 American Beauty soldering irons, Plomb, and Williams pliers are recommended.

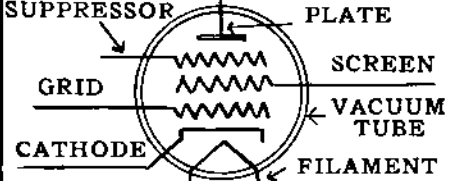
## Symbols Used in Radio Circuits

|   |  |  |   |   |                            |
|---|--|--|---|---|----------------------------|
|   | ANTENNA<br>OR AERIAL                     |    | VARIABLE<br>CONDENSER                         |   | QUARTZ<br>CRYSTAL          |
|  | CHASSIS<br>OR GROUND                     |   | ELECTROLYTIC<br>CONDENSER<br>SHOWING POLARITY |  | CONNECTION<br>OF TWO WIRES |
|  | AIR CORE<br>COIL                         |   | SWITCH  |  | NO<br>CONNECTION           |
|  | AIR CORE<br>TRANSFORMER<br>OR COIL       |   | ROTARY<br>SWITCH                              |  | FUSE                       |
|  | R.F. CHOKE                               |   | SPEAKER                                       |  | PHONE<br>PLUG              |
|  | FILTER OR<br>IRON CORE<br>CHOKE . . .    |   | METER   | K =   | 1000                       |
|  | IRON CORE<br>TRANSFORMER                 |   | PILOT<br>LIGHT                                | M =   | 1,000,000                  |
|  | FIXED<br>RESISTOR                        |   | PHONE<br>JACK                                 |  | OHM.                       |
|  | VARIABLE<br>RESISTOR OR<br>POTENTIOMETER |  |   | MF =  | MICROFARAD                 |
|  | FIXED<br>CONDENSER                       |  |   | MMF =   | MICRO<br>MICROFARAD        |

**THE HEATH COMPANY . BENTON HARBOR, MICH.**

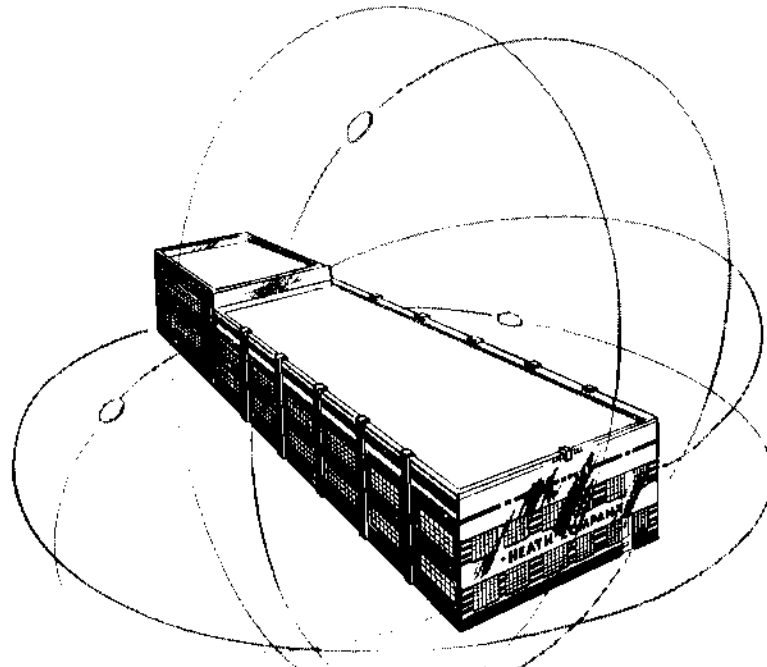

THE HEATH COMPANY  
BENTON HARBOR, MICH.