

PRICE \$1.00

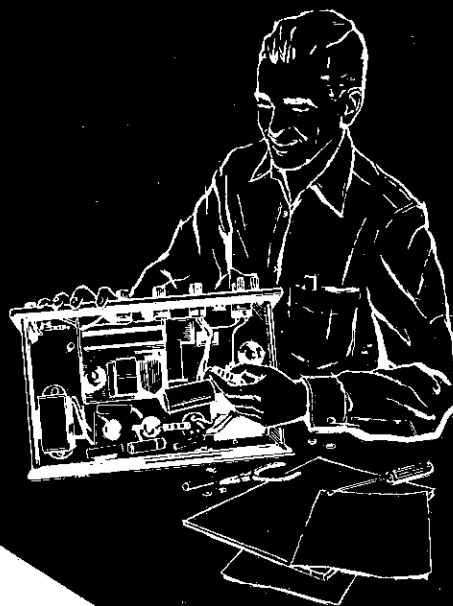

**Assembling
and Using Your...**

Heathkit

**FREQUENCY
MODULATION
TUNER**

MODEL FM-3A

HEATH COMPANY

A Subsidiary of Daystrom Inc.

BENTON HARBOR, MICHIGAN

STANDARD COLOR CODE — RESISTORS AND CAPACITORS

AXIAL LEAD RESISTOR	INSULATED UNINSULATED Color	FIRST RING BODY COLOR First Figure	SECOND RING END COLOR Second Figure	THIRD RING DOT COLOR Multiplier	DISC CERAMIC RMA CODE
	BLACK BROWN RED ORANGE YELLOW GREEN BLUE VIOLET GRAY WHITE	0 1 2 3 4 5 6 7 8 9	0 1 2 3 4 5 6 7 8 9	None 0 00 ,000 0,000 00,000 000,000 0,000,000 00,000,000 000,000,000	

The standard color code provides all necessary information needed to properly identify color coded resistors and capacitors. Refer to the color code for numerical values and the zeroes or multipliers assigned to the colors used. A fourth color band on resistors determines tolerance rating as follows: Gold = 5%, Silver = 10%. Absence of the fourth band indicates a 20% tolerance rating.

The physical size of carbon resistors is determined by their wattage rating. Carbon resistors most commonly used in Heathkits are 1/2 watt. Higher wattage rated resistors when specified are progressively larger in physical size. Small wire wound resistors 1/2 watt, 1 or 2 watt may be color coded but the first band will be double width.

MOLDED MICA TYPE CAPACITORS

CURRENT STANDARD CODE 	RMA 3-DOT (OBSOLETE) RATED 500 W.V.D.C. ± 20% TOL. 	BUTTON SILVER MICA CAPACITOR
RMA (5-DOT OBSOLETE CODE) 	RMA 6-DOT (OBSOLETE) 	RMA 4-DOT (OBSOLETE)

MOLDED PAPER TYPE CAPACITORS

AXIAL CAPACITOR <p>Normally stamped for value</p>	MOLDED FLAT CAPACITOR 	JAN. CODE CAPACITOR
-------------------------------------------------------------	----------------------------------	--------------------------------

The tolerance rating of capacitors is determined by the color. For example: red = 2%, green = 5%, etc. The voltage rating of capacitors is obtained by multiplying the color value by 10. For example; orange = 3 × 100 or 300 volts. Blue = 100 or 600 volts.

In the design of Heathkits, the temperature coefficient of ceramic or mica capacitors is not generally a critical factor and therefore Heathkit manuals avoid reference to temperature coefficient specifications.

Courtesy of Centralab

ASSEMBLY AND OPERATION OF THE HEATHKIT MODEL FM-3A FREQUENCY MODULATION TUNER

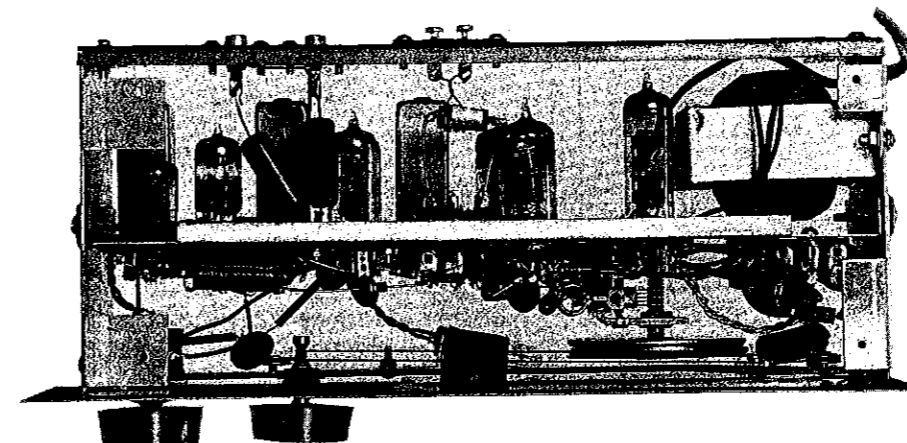
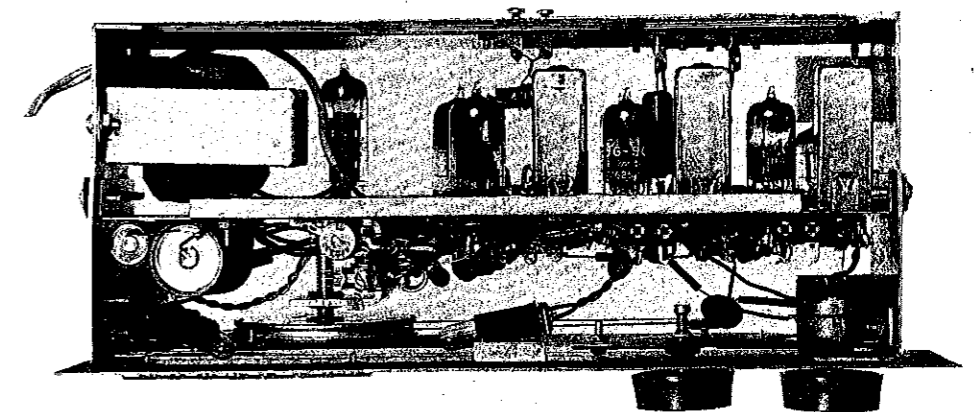
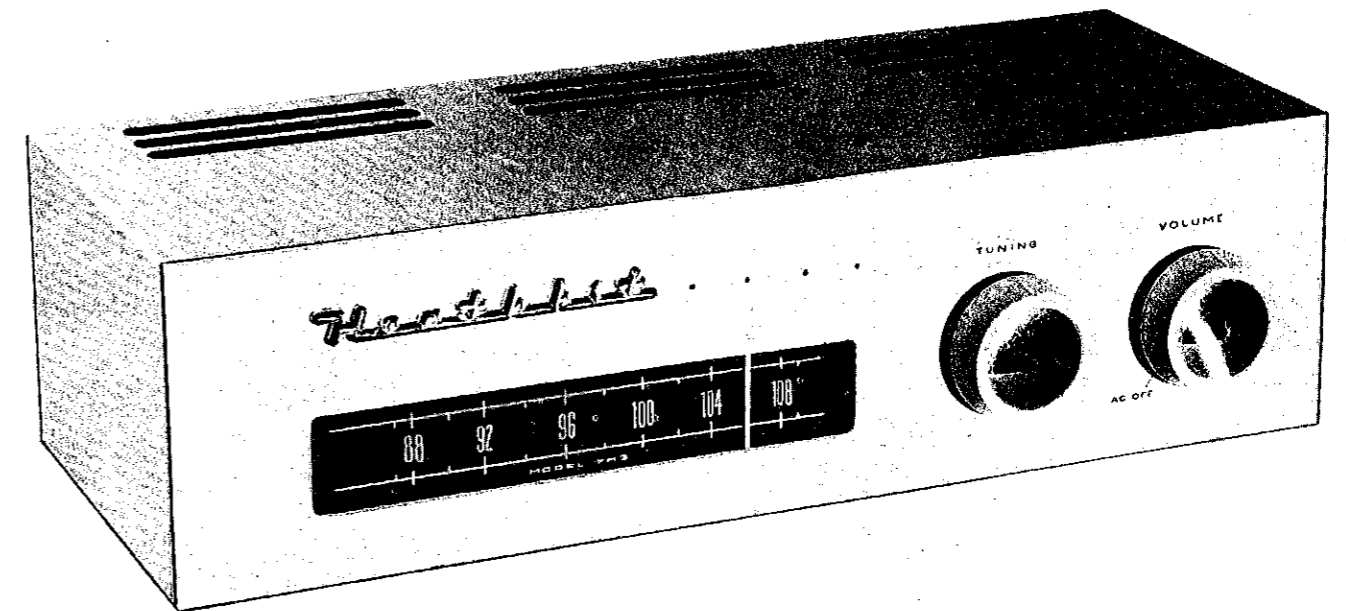

CONDITIONS: 78 FM generator terminated with 150 Ω resistors between output terminals and FM-3 input terminals to properly match impedance. Line voltage, 117 volts 60 cycles AC. Measurements taken from high level output with input frequency 98 mc unless otherwise stated.

FEATURES

Most commercial high fidelity FM tuners conform to a definite circuit configuration and general performance figures are much the same for all of them. Fine performance is obtainable from these tuners, but the numerous tubes and complex circuits tend to make them prohibitively expensive. With a few exceptions, the limiter-discriminator type of tuner is almost universally used. Unfortunately, the wide use of this type circuit seems to have put an unfair stigma against other types, even though they are capable of equal or superior performance.

A ratio detector is used in the Heathkit FM-3A FM Tuner, for it is simple, inexpensive and easy to align. The ratio detector is capable of excellent performance and has the advantage of being self AM limiting, eliminating the need for two limiter stages. This design economy seems to have made some high fidelity enthusiasts suspicious of the circuit, without good reason for this feeling. An advantage is gained by not using limiters, since the "limiting threshold" is eliminated. Weak FM stations cannot overcome this threshold and so are heard highly distorted and with high background noise. Obviously, these stations cannot be enjoyed and the usefulness of the tuner is limited to stronger stations, although the tuner may be specified as 5 microvolts for 30 db quieting. The standard type of discriminator is sensitive to AM and if the limiters do not remove all AM from the IF carrier, severe distortion and high noise levels will result. Performance of the ratio detector on strong stations is much the same as the widely used detector circuit, but is substantially superior on weak stations which are received at a signal strength roughly equivalent to the specified sensitivity of the tuner. Of course noise levels will rise with very poor signals, but the accompanying distortion does not occur until the signal becomes too weak to be useful at all.

The only disadvantage of the ratio detector is that the audio output is dependent on signal strength to some extent. It is for this reason that a volume control is used on the FM-3A tuner. AGC voltage taken from the detector to the RF amplifier helps to even out the response to weak and strong signals so that the variations are not very noticeable except in the case of extremely weak stations.

High gain tubes are used in the IF and mixer stages of the tuner to give high sensitivity and to aid the detector in its function. A high gain, low noise cascode type RF amplifier is used for the same reason, as well as to isolate the local oscillator from the antenna. Loading and "pulling" of the oscillator by the antenna circuit is minimized in this manner and external radiation from the oscillator is substantially reduced.

An audio amplifier stage is an added advantage, since it provides adequate output to drive any amplifier system regardless of sensitivity and also can drive high impedance earphones for private listening. A fixed level output direct from the detector is available for those who prefer to control the audio system at the preamplifier only.

Sensitivity of the Heathkit FM-3A tuner is high enough that very satisfactory performance will be obtained with an indoor antenna made up of 300 Ω twin lead, if reasonable signal strength is prevalent in the area. Best "fringe" performance will be obtained with an outdoor type of antenna as discussed in the manual.

INTRODUCTION

Although low in price, the Heathkit FM-3A FM Tuner is soundly engineered and is capable of high sensitivity, stable performance. Careful chassis layout, straightforward circuit design and specially selected components contribute to this result.

Two outputs are provided, one at low level which is not affected by the volume control on the tuner, and the other at high level which is controllable. Thus, the tuner can be used with high gain high fidelity systems which have a level set control on the input, such as the Heathkit WA-P2 Preamplifier, or with any amplifier by using the high level controllable output.

Good performance can be obtained by connecting high level output to transformer operated portable phonograph players which have an extra input connection provided or radio and TV sets which have phono inputs. Practically any transformer operated radio or TV set can be modified for use as an amplifier and any competent serviceman can make this addition at a nominal charge. The tuner must not be operated with AC-DC equipment. See instructions under "Installation" in back of manual.

For best performance, the tuner should be used with a high fidelity type of system, since it is only with a wide range system that the full benefit of FM can be realized. The advantage of FM over AM reception will be readily apparent with any type of amplifier, however.

CIRCUIT DESCRIPTION

The Heathkit FM-3A FM Tuner is a seven tube, AC operated superheterodyne receiver employing high gain tubes in all RF circuitry. Careful layout of the components allows this high gain to be realized without troublesome instability.

A high gain cascode type radio frequency (RF) amplifier is used ahead of the tuner to increase the overall gain of the receiver and to reduce oscillator and other RF leakage to the antenna. A 6BQ7A twin triode tube is employed in this circuit, connected in an unconventional manner. Incoming signal is first applied to the antenna coil, the purpose of which is to match the antenna impedance (300 Ω) to the tube input impedance and to tune this input to the FM broadcast band. This coil is "broadbanded" to tune the entire FM band at once by using a low value resistor and condenser across the coil. Automatic Gain Control (AGC) is used on the 6BQ7A input grid, so it is necessary to feed the signal from the coil to the grid through a 47 μf condenser which will pass the high frequency RF, but will block the Direct Current (DC) from the antenna coil.

The first half of the 6BQ7A tube acts as a conventional triode voltage amplifier. Its plate load is made up of the plate resistance of the second half of the tube which is in series with the first and the 10 K Ω resistor connected to B+ (high voltage DC). Voltage amplified by the first half of the tube is connected through a neutralizing choke to the cathode of the second half, causing it to swing by approximately the same amount. The neutralizing choke is made to be resonant with the circuit and tube capacity in the middle of the FM band, which gives added gain to the stage and prevents oscillation. Gain in the second half of the tube is accomplished by effectively tying the grid to ground through a .001 μf condenser and isolating the grid from the cathode with a 470 K Ω resistor. Thus, the grid remains at a fixed potential while the cathode voltage is varied, causing the tube to act as though the grid potential were changing. Operation is much the same as a grounded grid amplifier. Loading for the second half of the 6BQ7A is provided by a 10 K Ω resistor tied to B+ and this load is tuned through a 3.3 μf condenser to the RF coil on the tuning condenser assembly. The main advantage of this circuit is that high gain, equivalent to that of a pentode, can be obtained at a much lower noise figure.

Signal from the RF amplifier and RF coil on the tuning assembly is coupled to the 6U8 pentode grid through a 47 μf condenser and the signal is amplified. The triode section of the 6U8 is used as an oscillator of the standard Hartley type. Since the oscillator and RF signals are both present in the tube, they mix in such a manner that the sum and difference of the two frequencies are present at the output of the pentode, as well as the RF and oscillator signal.

The oscillator frequency is selected so it is always 10.7 megacycles (mc) higher than the frequency of the RF section. Therefore, the difference will always be 10.7 mc. It is to this frequency that the intermediate frequency (IF) transformers are tuned. This function of changing frequencies is known as the Superheterodyne Principle. Improved selectivity and gain is obtained due to the fixed tuned IF transformers, which are designed to give optimum performance at one frequency only.

Amplification of the IF signal takes place in the first 6CB6 stage. The first IF transformer passes the 10.7 mc signal and rejects almost all unwanted signals. This signal is connected to the grid of the 6CB6 tube. The signal is boosted or amplified by the tube and fed to the second IF transformer, which is connected to the plate circuit of the 6CB6. Any residual unwanted signal that might remain is eliminated by this transformer. Exactly the same thing happens in the second 6CB6 IF stage. Additional amplification takes place and the signal is passed on to the ratio detector transformer which is connected to the plate of the tube.

Detection of an FM signal involves a different principle than that used for AM demodulation, due to the different nature of the transmitted signal. Amplitude Modulation (AM) refers to a carrier signal whose amplitude or strength is varied at a rate depending on the frequency of the modulating intelligence and whose height depends on the relative volume or loudness of the audio, the carrier frequency remaining constant. For FM, the carrier amplitude is held constant and the carrier frequency varies on both sides of the center frequency at a rate determined by the modulating frequency and a frequency swing proportional to the volume of the modulating sound.

Thus it is apparent that any amplitude variations on an FM signal contribute nothing to the detected audio and so amplitude variations can be clipped off in the IF stages or cancelled out in the detector, which is done in the Heathkit FM-3A. Random noise, ignition pulses from gasoline engines and electric motors and static from electrical storms are all forms of amplitude modulation which come through an AM receiver as interference but are eliminated or substantially reduced in an FM receiver due to its AM suppressing action. Hence, the quiet performance of FM which makes it so ideal for high fidelity listening.

A Ratio Detector is used to demodulate the FM signal in this tuner. The two halves of a 6AL5 duo-diode are connected in a series fashion through the ratio detector transformer. Connections to the tube are indicated on the schematic diagram. Contrary to usual practice with the somewhat better known discriminator type of detector, one winding of the transformer secondary is connected to a diode plate, while the other is connected to the cathode of the remaining diode. The remaining plate and cathode are connected to a balanced resistance network and an electrolytic condenser. When IF signal is present at 10.7 mc, a reference DC voltage is established at the condenser. Frequency deviations from the 10.7 mc center result in positive or negative current variations depending on direction of frequency swing. These variations are taken out as audio voltage from a tap at the center of the transformer secondary. An RF reference for this secondary is furnished by a third winding, which sets up the phase relationships necessary for FM detection. Amplitude modulation of all types will be applied to both diodes at the same time with a resulting increase in average current drawn through the two diodes. Voltage surges of this type are absorbed by the reference electrolytic condenser previously mentioned and are thus cancelled out. A certain amount of unbalance will always be present in the circuit however so some response to noise will be evident when listening to weak signals.

Audio from the tap on the transformer secondary is passed through a 68 Ω resistor and a 270 $\mu\mu\text{f}$ condenser network to bypass all remaining IF energy to ground, leaving only pure audio signal. Next, this signal is passed through a 68 K Ω resistor and a .001 μfd condenser network, which comprises the "de-emphasis" network required to restore the audio to a "flat" response. High frequency "pre-emphasis" is used at the transmitter to keep low frequency deviation down and to improve signal to noise ratio at the receiver. "De-emphasis" at the receiver attenuates high audio frequencies at the same rate as the pre-emphasis at the transmitter and the resulting response is "flat." Most noise picked up by and generated in the receiver falls in the high audio frequency range and this noise is attenuated by the de-emphasis network at the same time as the audio is flattened out.

Signal from the de-emphasis network is connected to the volume control, which is a fixed resistor with a sliding tap. By moving the position of the tap it is possible to select any desired portion of the entire signal appearing across the fixed terminals of the control. The low level fixed amplitude signal is taken out of the fixed resistance terminals of the control and so the control has no effect on this output. Output from the variable tap is connected through a condenser to the grid of the 6C4 audio amplifier.

Conventional circuitry is used in the 6C4 stage which is wired as a standard resistance-capacity coupled amplifier. An unbypassed cathode bias resistor is used and this resistor reacts with the cathode circuit to provide bias for the tube. Although stage gain is reduced by not using a bypass condenser, noise and distortion are reduced even more because of the current feedback introduced by the unbypassed cathode resistor. A low value of plate load resistance is used (47 K Ω) to keep output impedance low. This is desirable in order to reduce hum pickup in the interconnecting audio cable and to minimize high frequency loss.

In order to avoid distortion, loss of gain and overload, it is necessary to "bias" the tubes in an RF or audio amplifier in some manner. This term refers to application of a negative potential on the grid of a tube in respect to the cathode. If the grid (the tube control element) is at the same potential as the cathode (the heated electron emitting element), an applied signal voltage will cause the grid to draw current since the grid and cathode form a rectifier, or diode, under these conditions. When grid current is drawn, the portion of the waveform involved is clipped off or distorted by the diode action. In most cases, this is very undesirable and bias is applied to the grid so that signal voltage can be varied without swinging the grid potential positive in respect to the cathode. A number of methods can be used to obtain a negative voltage on the grid, two different methods being used in the FM-3A. The 6BQ7A, 6CB6's and the 6C4 employ cathode bias, where the current drawn by the tube is passed through a resistor in the cathode circuit, causing the cathode to become positive in respect to ground. Since the grid is tied to ground through a resistor or an IF transformer, the cathode will be positive in respect to the grid, which is the same as making the grid negative in respect to the cathode.

Contact bias is used in the 6U8 stage. If the cathode of a tube is tied directly to circuit ground and the grid returned to ground through a high resistance, a very small amount of current will be drawn by the grid. This current will be limited by the resistor however, and a slight negative voltage will appear at the grid. Biasing in this manner is useful where cathode impedance must be kept low and the signal level is low.

AGC (automatic gain control) action is obtained by feeding the negative DC voltage developed at the 6AL5 ratio detector back to the 6BQ7A RF and 6CB6 first IF amplifier grid through an isolating network consisting of a 330 K Ω resistor and a .01 μfd condenser. This network filters out all RF, IF and audio energy, preventing interaction between the input and output stages of the tuner. The DC voltage developed at the 6AL5 is proportional to the incoming signal strength and so is useful as a gain controlling voltage. When the voltage, or bias, at the grid of a tube is increased in a negative direction, the gain will be reduced. Thus, the stronger the signal, the less sensitive the set becomes, which tends to keep the audio level relatively constant and prevents overloading when tuned to very strong signals.

Power for the receiver is obtained from the power supply, which involves the power transformer, the 6X4 tube and the electrolytic filter condenser. The transformer supplies filament voltage for all tubes and high AC voltage to the plates of the rectifier. The rectifier action is exactly the same as that taking place in the 6AL5 diode detector described above. The output voltage is a series of positive pulses, one for each half of the 60 cycle line waveform. The voltage applied to the tubes must be free of these pulses, or ripple, or only a loud buzz will be evident from the speaker system. It is for this reason that the high capacity filter condenser is used. The first section of the condenser charges to the voltage from the 6X4 tube. When the tube is not conducting, the condenser starts to discharge through the load presented by the other tubes in the receiver. However, the next positive charge takes place before the condenser has time to discharge fully, so the voltage is smoothed out somewhat.

Final filtering action takes place in the second section of the filter condenser. This section is isolated from the first by a 1000 Ω resistor which tends to help smooth the voltage because it resists current variations in the filter circuit. The second section of the condenser smooths out any variations passed by the first part of the condenser and the voltage output is "pure" direct current (DC).

NOTES ON ASSEMBLY AND WIRING

The Heathkit FM Tuner model FM-3A when constructed in accordance with the instructions in this manual, is a high quality tuner capable of many years of trouble free service. We therefore urge you to take the necessary time to assemble and wire the kit carefully. Do not hurry the work and you will be rewarded with a greater sense of confidence, both in your tuner and your own ability.

This manual is supplied to assist you in every way to complete the instrument with the least possible chance for error. We suggest that you take a few minutes now and read the entire manual through before any work is started. This will enable you to proceed with the work much faster when construction is started. The large fold-in pictorials are handy to attach to the wall above your work space. Their use will greatly simplify the completion of the kit. These diagrams are repeated in smaller form within the manual. We suggest that you retain the manual in your files for future reference, both in the use of the tuner and for its maintenance.

UNPACK THE KIT CAREFULLY AND CHECK EACH PART AGAINST THE PARTS LIST. In so doing, you will become acquainted with each part. Refer to the charts and other information shown on the inside covers of the manual to help identify any parts about which there may be a question. Hardware parts are identified pictorially in the back of the manual, after the parts list. If some shortage is found in checking the parts, please notify us promptly and return the inspection slip with your letter to us. Hardware items are counted by weight and if a few are missing, please obtain them locally if at all possible. Handle the tuning assembly with care. Calibration will be destroyed if coils are bent or trimmer condensers turned.

Read the note on soldering on the inside of the back cover and the instructions under WIRING OF THE FM-3A FM TUNER. Crimp all leads tightly to the terminal before soldering. Be sure both the lead and terminal are free of wax, corrosion or other foreign substances. Use only the best rosin core solder, preferably a type containing the new activated fluxes such as Kester "Resin-Five," Ersin "Multicore" or similar types.

Resistors and controls generally have a tolerance rating of $\pm 20\%$ unless otherwise stated in the parts list. Therefore, a 100 K Ω resistor may test anywhere from 80 K Ω to 120 K Ω . (The letter K is commonly used to designate a multiplier of 1000.) Tolerances on condensers are generally even greater. Limits of $+100\%$ and -50% are common for electrolytic condensers. The parts furnished with your Heathkit have been specified so as to not adversely affect the operation of the finished instrument.

In order to expedite delivery to you, we are occasionally forced to make minor substitutions of parts. Such substitutions are carefully checked before they are approved and the parts supplied will work satisfactorily. By checking the parts list for resistors, for example, you may find that a 120 K Ω resistor has been supplied in place of a 100 K Ω as shown in the parts list. These changes are self-evident and are mentioned here only to prevent confusion in checking the contents of your kit.

We strongly urge that you follow the wiring and parts layout shown in the manual. The position of wires and parts is quite critical in this tuner and changes may result in oscillation or other undesirable performance characteristics.

STEP-BY-STEP ASSEMBLY INSTRUCTIONS

The Heathkit FM-3A FM Tuner is a complex and critical instrument. We very strongly urge that the step-by-step instructions be followed exactly, rather than constructing the unit from pictorials and schematic alone. Special instructions regarding sequence of assembly and lead lengths are given to make construction of the kit as easy as possible. Wiring and mounting parts improperly may result in instability and it may be necessary to re-do work previously accomplished.

The following instructions are presented in a simple, logical, step-by-step sequence to enable you to complete your kit with the least possible confusion. Be sure to read each step all the way through before you start to do it. When the step is completed, check it off in the space provided.

We suggest you do the following before any work is started:

1. Attach the large fold-in pictorials to the wall above your work space.
2. Go through the entire assembly and wiring instructions. This is an excellent time to read the entire instructions section through and familiarize yourself with the procedure.
3. Lay out all parts so that they are readily available. Refer to the general information inside the front and rear covers of this manual to help you identify components.

In assembling this kit, use lockwashers under all nuts, unless otherwise specified. Tube sockets are mounted on the wiring side of the chassis, the same as most other components. Other details of construction are included where pertinent in the instructions.

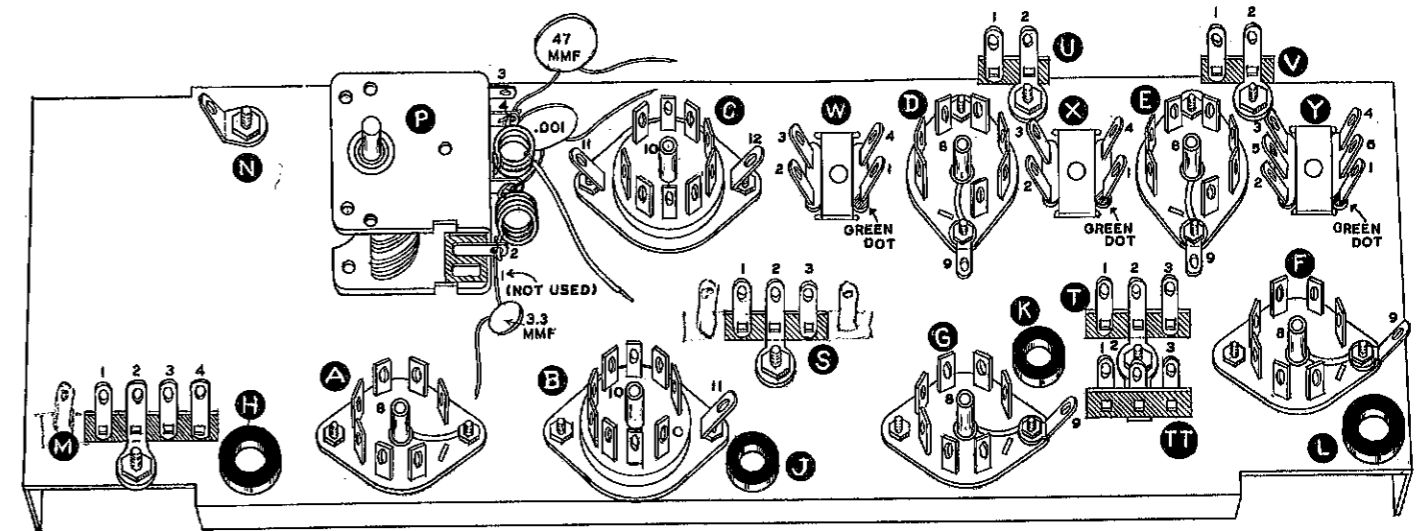
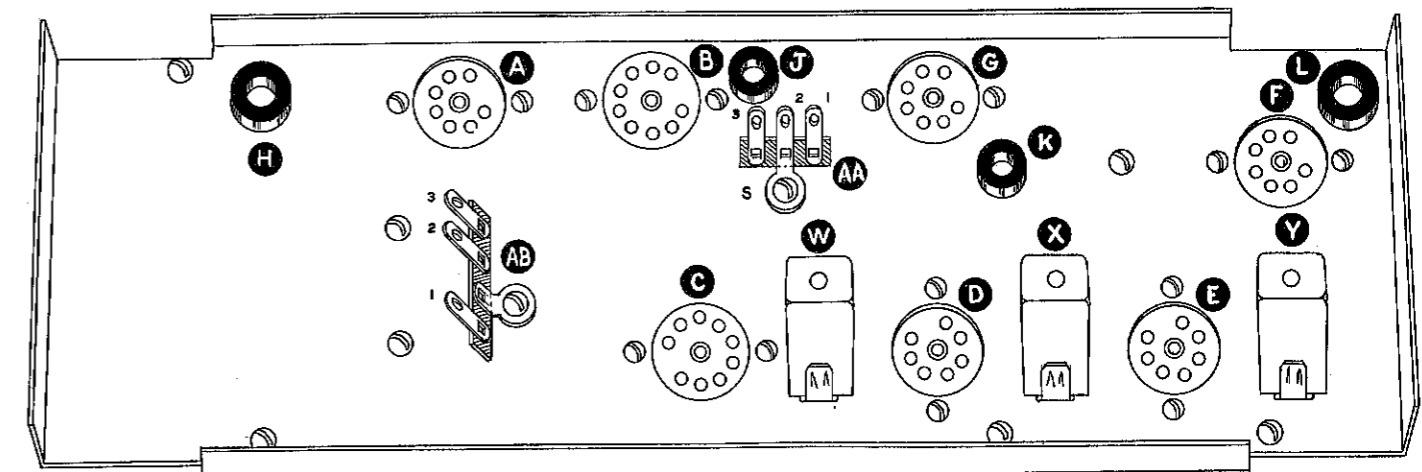

Figure 1



CHASSIS TOP

Figure 2

- () Place the chassis on the bench so that it corresponds to Figure 1. The cutouts for the IF transformers must be located at the upper right. Note that this chassis is used in a different manner, in that all wiring is done on the open side and this side is considered as the chassis bottom. When observing the chassis with the flanges upward, you are looking at the top. If in doubt, check the pictorials and the inside photographs on Page 1.

(✓) Mount a 7-pin tube socket at location A. Use 3-48 screws and nuts, with lockwashers under both nuts. Make sure that the entire socket is mounted on the wiring or bottom side of the chassis. The pins will short to the chassis if the socket is mounted on top. Place the gap between pins 1 and 7 to the right as shown in Figure 1. Refer to Figure 4 and note clockwise pin number sequence.

(✓) In similar fashion, install a 9-pin socket at location B. Mount a ground lug under the right hand nut as shown. Orient the socket in the same direction as socket A. Bend the ground lug straight up. Observe Figure 3.

(✓) In the same manner, mount a 9-pin socket at C. Observe socket orientation. Place a ground lug under each nut and bend straight up. Observe Figure 3.

(✓) Install a 7-pin socket at location D with 3-48 hardware. The blank space between pins 1 and 7 is toward the center of the chassis. Mount a ground lug under the centermost nut and bend up.

(✓) Similarly, mount a 7-pin tube socket at location E. Place a ground lug under the nut nearest the center of the chassis and bend up.

(✓) Mount a 7-pin tube socket at location F, with the gap between pins 1 and 7 to the right. Install a ground lug under the nut nearest the gap and bend up.

(✓) Install a 7-pin tube socket at location G in the same fashion, with a ground lug under the nut nearest the gap. Bend the lug upward.

(✓) Mount 3/8" rubber grommets in holes H and L.

(✓) Mount 5/16" rubber grommets in holes J and K.

(✓) Install a 2-lug terminal strip (1-lug grounded) at location U, using 6-32 x 3/8 hardware. Orient as shown in Figure 1.

(✓) Mount a 2-lug terminal strip (1-lug grounded) at location V in the same manner.

(✓) At location T, secure two 3-lug terminal strips with one 6-32 x 3/8 bolt as shown.

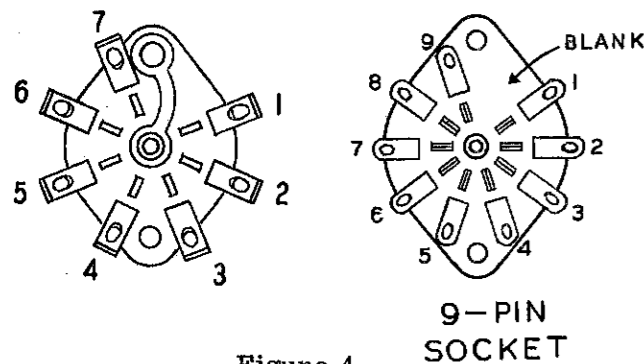

Figure 4

9-PIN SOCKET

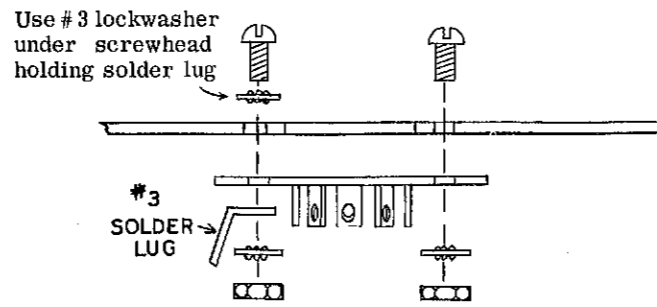

Figure 3

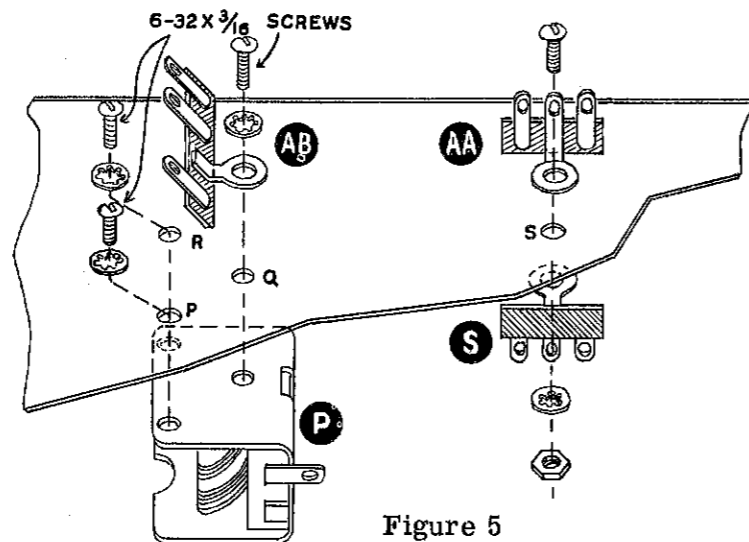

Figure 5

(✓) Secure a 4-lug terminal strip (1 lug grounded) at location M, orienting as shown in Figure 1.
 (✓) Install the #6 solder lug with a 6-32 x 3/8 screw and nut at location N. No lockwasher is needed since this lug incorporates a self-locking feature.

(✓) Refer to Figures 1, 2 and 5 and place a 6-32 x 3/8 screw through a 3-lug terminal strip, through chassis location S from the top, a 3-lug terminal strip, lockwasher and nut. Observe the orientation of the two strips.

(✓) Observe Figure 6 and mount a 4-lug IF transformer at location W, on top of the chassis. This transformer is placed so that the green dot or #1 lug is nearest pin 1 of socket D. Hold the transformer in place with your fingers or hold the assembly against the workbench and push a mounting clip through the two remaining chassis slots. Push one side down until the clip locks in place on one side of the transformer. Then push the other side down with a screwdriver until the end locks in place on the opposite side of the transformer.

(✓) In the same manner, install a 4-lug IF transformer at location X, with the green dot nearest pin 1 of socket E.

(✓) Similarly, install the 5 or 6-lug ratio detector transformer at Y. The side with a green dot should be to the right and the number 1 pin near pin 7 of socket F. In some instances lug #5 may be missing from the transformer.

NOTE: The tuning assembly has been carefully adjusted at the factory. Since these adjustments are critical, the unit must be handled very carefully if calibration is to be maintained. Avoid touching the coils and leave the condenser plates fully meshed to avoid damaging them.

(✓) Mount the tuning condenser assembly at location PQR orienting it as shown. Place short 6-32 x 3/16 screws through locations P and R, with lockwashers under the heads. Observe Figure 5. Do not install a screw at Q yet. Dress the .001 μfd disc condenser under the oscillator coil as shown in Pictorial 1 and Figure 8.

(✓) Place a small 6-32 x 3/16 screw through a lockwasher and 3-lug terminal strip and then through location Q into the remaining mounting of the tuning assembly. See Figures 2 and 5.

This completes the mechanical assembly of the chassis.

WIRING OF THE FM-3A FM TUNER

NOTE: ALL GUARANTEES ARE VOIDED AND WE WILL NOT REPAIR OR SERVICE INSTRUMENTS IN WHICH ACID CORE SOLDER OR PASTE FLUXES HAVE BEEN USED. WHEN IN DOUBT ABOUT SOLDER, IT IS RECOMMENDED THAT A NEW ROLL PLAINLY MARKED "ROSIN CORE RADIO SOLDER" BE PURCHASED.

Pictorial 1 on Page 14 is a representation of the completed main chassis wiring. We again suggest that you use the large fold-in pictorials for reference as the work progresses. They are duplicates of the pictorials in the manual. Read the notes on the inside rear cover and on Page 12 concerning wiring and soldering.

Refer to Pictorial 1. Note that each component part has been given a code designation which corresponds with the identification used during the assembly of the kit. In addition, each terminal on the part has also been assigned a number.

When the instructions read, "Connect one end of a 100 KΩ resistor to tube socket A2 (NS)," it will be understood that the connection is to be made to contact pin 2 of tube socket A. The abbreviation "NS" indicates that the connection should not be soldered as yet, for other wires will be added. When the last wire is installed, the terminal should be soldered and the abbreviation "S" is used to indicate this.

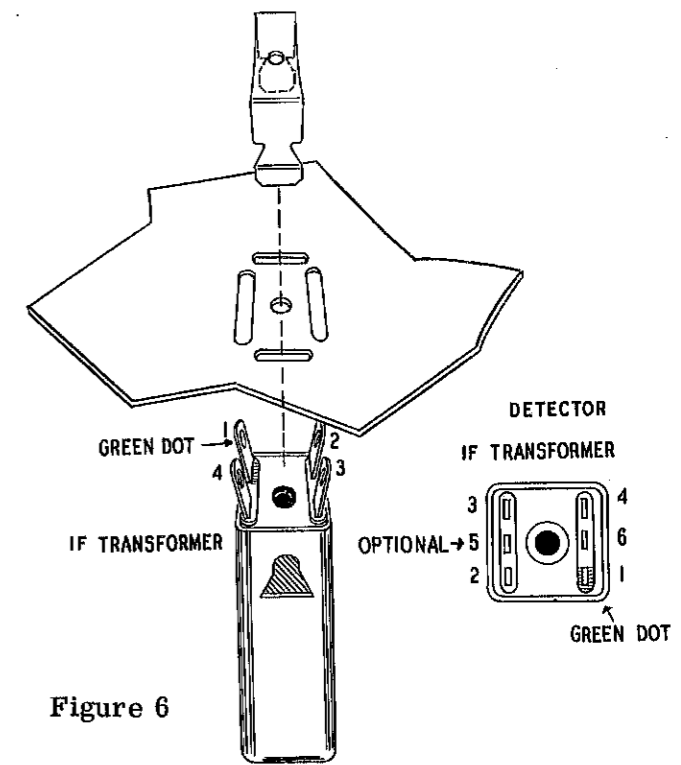

Figure 6

Unless otherwise indicated, all wire used is insulated. Wherever there is a possibility of bare leads on resistors and condensers shorting to other parts or to chassis, the leads should be covered with insulated sleeving. This is indicated in the instructions by the phrase "use sleeving." Bare wire is used where lead lengths are short and the possibility of short circuits non-existent.

Leads on resistors, condensers and transformers are generally much longer than they need to be to make the indicated connections. In these cases, the excess leads should be cut off before the part is added to the chassis. In general, the leads should be just long enough to reach their terminating points. Not only does this make the wiring much neater, but in many instances the excessively long leads will actually lead to instability or oscillation.

The pictorials indicate actual chassis wiring, designate values of the component parts and show color coding of leads where pertinent. We very strongly urge that the chassis layout, lead placement and grounding connections be followed exactly as shown. While the arrangement shown is probably not the only satisfactory layout, it is the result of considerable experimentation and trial. Grounding around the 6BQ7A and 6U8 is especially critical and changes will invariably lead to trouble with oscillation. If the layout is followed carefully, it will result in a stable instrument operating at a high degree of sensitivity and dependability.

Space has been provided for you to check off each operation as it is completed. This is particularly important in wiring and it may prevent omissions or errors, especially where your work is interrupted frequently as the wiring progresses. Some kit builders have also found it helpful to mark each lead in colored pencil on the pictorial as it is added.

Note that a number appears after each solder (S) instruction. This number indicates the number of leads connecting to the terminal in question. For example, if the instructions read "Connect a 470 K Ω resistor from socket B7 (S) (2) to B8 (NS)," it will be understood that there will be two leads connected to the terminal at the time it is soldered. This additional check will help avoid wiring errors.

PROPER SOLDERING PROCEDURE

Only a small percentage of Heathkit purchasers find it necessary to return an instrument for factory service. Of these, by far the largest proportion function improperly because of poor or improper soldering.

Correct soldering technique is extremely important. Good solder joints are essential if the performance engineered into the kit is to be fully realized. If you are a beginner with no experience in soldering, a half-hour's practice with odd lengths of wire and a tube socket will be a worthwhile investment.

High quality solder of the proper grade is most important. There are several different brands of solder on the market, each clearly marked "Rosin Core Radio Solder." Such solders consist of an alloy of tin and lead, usually in the proportion of 50:50. Minor variations exist in the mixture such as 40:60, 45:55, etc. with the first figure indicating the tin content. Radio solders are formed with one or more tubular holes through the center. These holes are filled with a rosin compound which acts as a flux or cleaning agent during the soldering operation.

NO SEPARATE FLUX OR PASTE OF ANY KIND SHOULD BE USED. We specifically caution against the use of so-called "non-corrosive" pastes. Such compounds, although not corrosive at room temperatures, will form residues when heated. The residue is deposited on surrounding surfaces and attracts moisture. The resulting compound is not only corrosive but actually destroys the insulation value of non-conductors. Dust and dirt will tend to accumulate on these "bridges" and eventually will create erratic or degraded performance of the instrument.

NOTE: ALL GUARANTEES ARE VOIDED AND WE WILL NOT REPAIR OR SERVICE INSTRUMENTS IN WHICH ACID CORE SOLDER OR PASTE FLUXES HAVE BEEN USED. WHEN IN DOUBT ABOUT SOLDER, IT IS RECOMMENDED THAT A NEW ROLL PLAINLY MARKED "ROSIN CORE RADIO SOLDER" BE PURCHASED.

If terminals are bright and clean and wires free of wax, frayed insulation and other foreign substances, no difficulty will be experienced in soldering. Crimp or otherwise secure the wire (or wires) to the terminal, so that a good joint is made without relying on solder for physical strength. To make a good solder joint, the clean tip of the soldering iron should be placed against the joint to be soldered so that the terminal is heated sufficiently to melt solder. The solder is then placed against both the terminal and the tip of the iron and will immediately flow out over the joint. Refer to the sketch below. Use only enough solder to cover wires at the junction; it is not necessary to fill the entire hole in the terminal with solder. Excess solder may flow into tube socket contacts, ruining the socket, or it may creep into switch contacts and destroy their spring action. Position the work so that gravity tends to keep the solder where you want it.

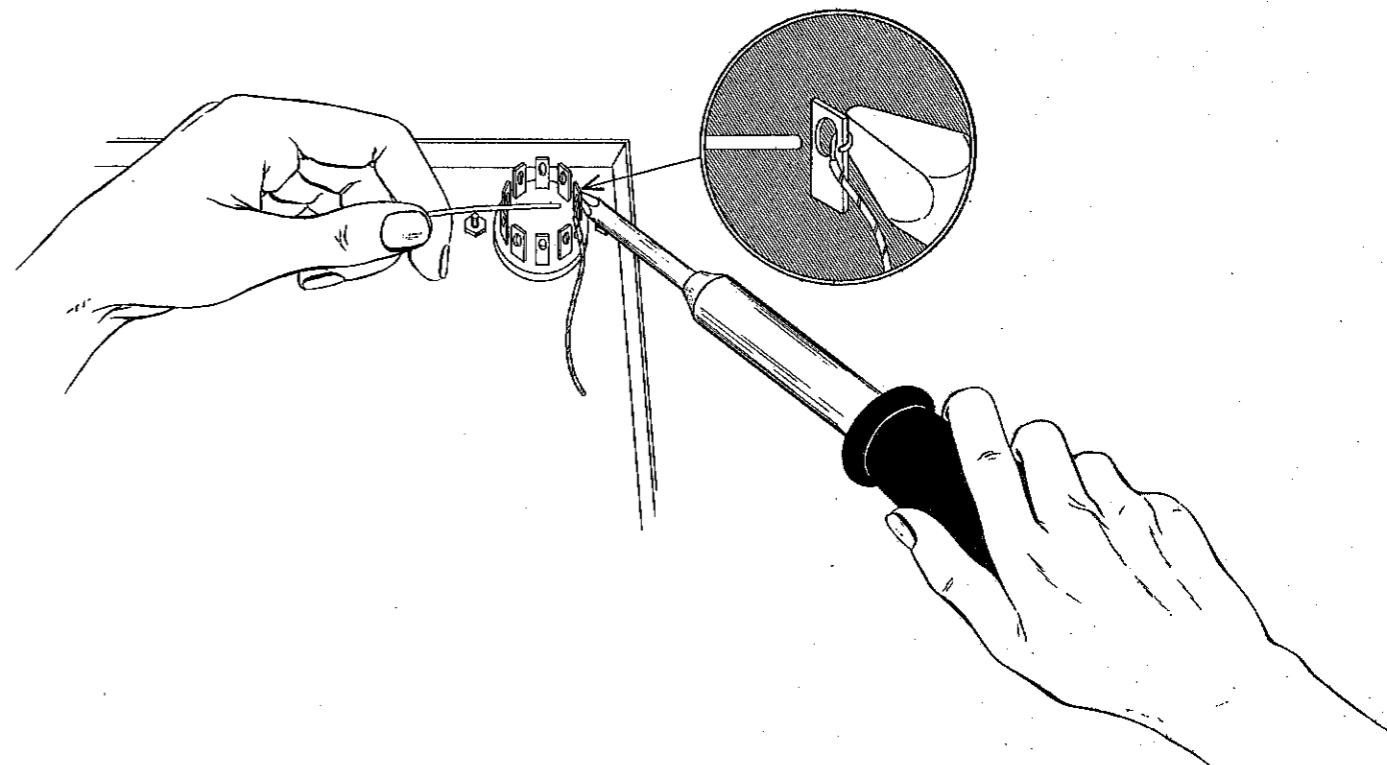

A poor solder joint will usually be indicated by its appearance. The solder will stand up in a blob on top of the connection, with no evidence of flowing out caused by actual "wetting" of the contact. A crystalline or grainy texture on the solder surface, caused by movement of the joint before it solidified is another evidence of a "cold" connection. In either event, reheat the joint until the solder flows smoothly over the entire junction, cooling to a smooth bright appearance. Photographs in the adjoining picture clearly indicate these two characteristics.

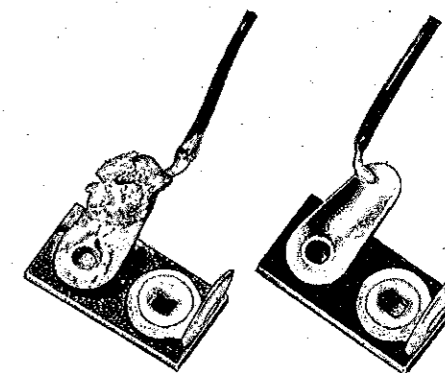

A good, clean, well-tinned soldering iron is also important to obtain consistently perfect connections. For most wiring, a 60 or 100 watt iron, or the equivalent in a soldering gun, is very satisfactory. Smaller irons generally will not heat the connections enough to flow the solder smoothly over the joint and are recommended only for light work, such as on etched circuit boards, etc. Keep the iron tip clean and bright. A pad of steel wool may be used to wipe the tip occasionally during use.

Take this precaution and use reasonable care during the assembly of the kit. This will insure the wonderful satisfaction of having the instrument operate perfectly the first time it is turned on.

- (✓) Connect a wire from terminal strip M3 (NS) to socket A5 (NS).
- (✓) Run a wire from terminal strip M1 (NS) to terminal strip S1 (NS). Dress the wire tight to chassis, between socket A and the tuning assembly.
- (✓) Connect a 100 Ω 1 watt resistor (medium size, brown-black-brown) from terminal strip M4 (NS) (use sleeving) to socket A7 (NS). Dress close to chassis.
- (✓) Route a wire from socket A5 (NS) tight to chassis between transformer W and socket D to terminal strip U1 (NS).
- (✓) Run a wire from terminal strip U1 (NS) to terminal strip V1 (NS).
- (✓) Connect a .001 μfd 1000 volt (1 kv) disc condenser from socket A7 (S) (2) to socket B4 (S) (3).

This completes the high voltage wiring to the B+ distribution points.

- (✓) Inspect the 20-20 μfd 350 volt electrolytic filter condenser. Note that two leads appear at one end and one at the other. Mount the condenser so that the end with two leads is toward terminal strip M. Place one of the leads through M3 and the other through M4 and push the condenser close to the terminal strip. Secure the connection at M3 (NS) and M4 (NS).
- * (✓) Connect the single lead at the opposite end of the condenser to ground lug N (NS).
- * () In the same manner, install the single section 20 μfd 150 volt electrolytic condenser from terminal strip M1 (NS) to ground lug N (S) (2). The + or positive end connects to M1.
- (✓) Install a 1 KΩ 2 watt resistor (large size, brown-black-red) from M3 (NS) to M4 (S) (3). Mount close to the terminal strip with the leads vertical in respect to chassis.
- * () Connect an 8.2 KΩ 1 watt resistor (medium size, gray-red-red) from terminal strip M1 (S) (3) to M3 (S) (4).

NOTE: The importance of short component and wire leads in high frequency equipment such as the Heathkit FM-3 Tuner cannot be overemphasized. Long leads will cause instability, oscillation and loss of sensitivity. Circuit wiring around sockets B and C is especially critical, since frequencies from 88 mc to 118.7 mc are present and the gain of the stages is extremely high. Unusually close wiring is employed in all signal carrying stages but it is not difficult if the instructions are followed exactly. "Picture wiring" is not recommended since the lead lengths become excessively long, even though the wiring may look much more attractive. The shortest distance between two points is always a straight line.

- (✓) Install a .001 μfd disc condenser from socket B7 (NS) to ground lug B11 (NS). Cut the leads so that they are just long enough to reach and dress the condenser close to chassis, over the wires already present.
- (✓) Connect a 470 KΩ resistor (yellow-violet-yellow) from socket B7 (S) (2) to B8 (NS). Mount as close to the socket as possible.
- (✓) Run a 10 KΩ resistor (brown-black-orange) from socket A5 (S) (3) (use sleeving) to socket B6 (NS). The resistor body should be close to B6.
- (✓) Connect the 3.3 μmf condenser already part of tuning assembly P2, to socket B6 (S) (2). Do not use any more lead length than absolutely necessary.

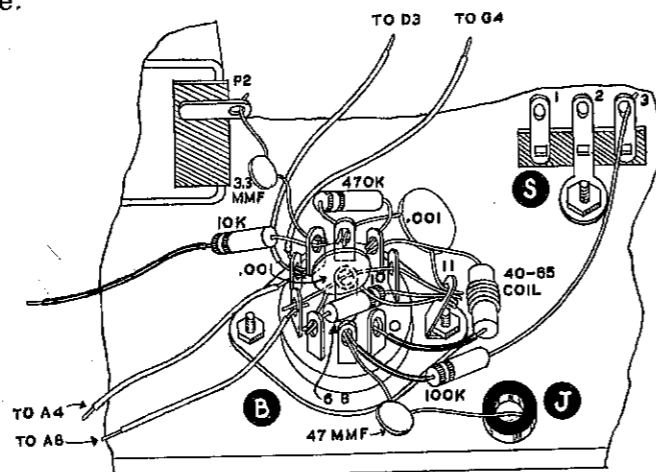

Figure 7

- (✓) Cut one lead of a 47 μmf disc condenser to a length of 3/8". Connect this lead to socket B2 (NS). Pass the free end through grommet J.
- (✓) On the opposite or top side of the chassis, connect the free end of the 47 μmf condenser appearing through grommet J to terminal strip AA3 (NS).
- (✓) On the top side of the chassis, connect a short bare wire from terminal strip AA1 (NS) to AA2 (S) (1).
- (✓) On the chassis bottom, connect a 100 KΩ resistor (brown-black-yellow) from socket B2 (S) (2) (use sleeving) to terminal strip S3 (NS). The resistor body should be close to B2.

- (✓) Run a 68 Ω resistor (blue-gray-black) from socket B3 (NS) between pin 1 and the center post to ground lug B11 (NS) as shown.
- (✓) Similarly, connect a .001 μfd disc condenser between socket B3 (S) (2) and ground lug B11 (S) (4). Dress the condenser directly over the resistor so that the disc is vertical in respect to chassis. When soldering B11, make sure the solder flows smoothly over all leads connected to the lug.
- (✓) Connect the 40-65 neutralizing choke, the component wound with a single layer of heavier wire, from socket B1 (S) (1) (use sleeving) to B8 (S) (2). The leads should be just long enough to allow choke to be dressed to the right of ground lug B11, without touching this lug. Make sure the end connected to B1 does not protrude beyond the chassis edge. In case of confusion, the neutralizing choke can be identified from the 45-1 filament choke by noting that it has heavier wire and fewer turns.

This completes the wiring of the 6BQ7A cascode RF amplifier stage. Carefully check all connections for secure soldering and make sure no short circuits exist.

- (✓) Install a .005 μfd disc condenser from IF transformer W4 (NS) (use sleeving) to ground lug C12 (NS). Dress close to chassis.
- (✓) Connect a .001 μfd disc condenser from socket C3 (NS) to ground lug C12 (NS). Dress close to chassis and keep leads short.
- (✓) Connect a 1 megohm resistor (brown-black-green) from socket C2 (NS) to ground lug C12 (S) (4). Make sure all leads are securely soldered at C12. Dress the resistor over the .001 μfd condenser connected to C3.
- (✓) Connect a 100 KΩ resistor (brown-black-yellow) from IF transformer W3 (NS) to socket C3 (S) (2).

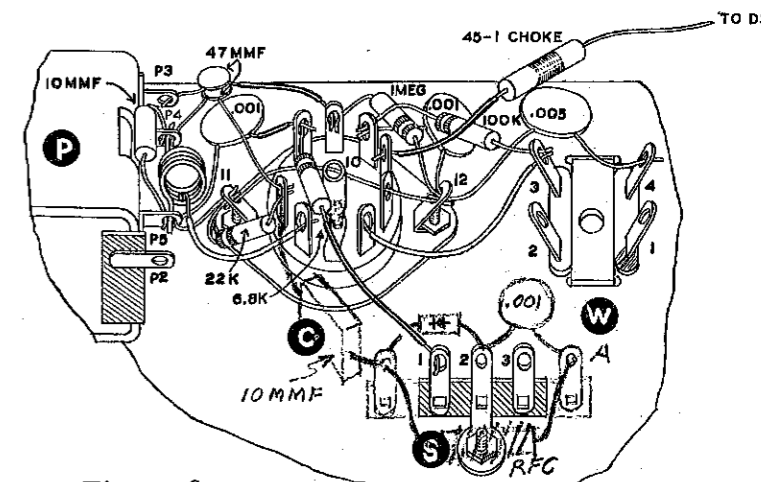

Figure 8

- (✓) Run a short piece of insulated wire from socket C6 (S) (1) to IF transformer W3 (S) (2).
- () Install the 45-1 filament choke (wound with finer wire) from socket D3 (NS) to socket C4 (S) (1) (use sleeving). Dress close to chassis around transformer W as shown.
- (✓) Bend pin 7 of socket C over until it rests tightly against center post C10. Solder the pin securely to the post (2), flowing solder to this connection and over the wire running through the post, to insure a good ground connection. Do not run a wire from pin 7 to the center post, since this makes the ground lead too long. (The two connections at the center post consist of the wire running through the post center and the pin soldered to the side of the post.)
- (✓) Connect a 22 KΩ resistor (red-red-orange) from socket C9 (NS) to ground lug C11 (S) (3). Keep the leads as short as possible.
- (✓) Run the coil tap wire which is one turn away from tuning assembly lug P5 on the oscillator coil to socket C8 (S) (1). Keep this wire straight and clip off excess, if any.
- (✓) Connect the 47 μmf condenser which is part of tuning assembly P4 to socket C9 (S) (2). Orient the condenser parallel with the chassis and clip lead to length just sufficient to reach C9.
- (✓) Install a 47 μmf disc condenser from tuning assembly lug P3 (S) (1) to socket C2 (S) (2) (use sleeving). Note that the condenser is installed so that the body is directly above the 47 μmf condenser connected to P4. After completing the soldering operation, press the two condensers together so that the insulated bodies touch each other. Do not let the bare wires touch. This operation creates coupling capacity between the oscillator and mixer circuits, increasing efficiency and sensitivity.

- (✓) Run a 6.8 K Ω 1 watt resistor (medium size, blue-gray-red) from socket C1 (S) (2) to terminal strip S1 (NS) (use sleeving). Dress the resistor body close to C1 over the center post C10.
- (✓) Connect a 10 K Ω resistor (brown-black-orange) from terminal strip U1 (NS) to transformer W4 (S) (2). The resistor body should rest over the leads on socket D3.
- (✓) Run a short bare wire from IF transformer W2 (S) (1) to terminal strip S3 (NS).
- (✓) Bend transformer lug W1 and socket lug D1 toward each other and hook W1 through the opening in D1. Solder the junction (1).

The 6U8 oscillator mixer stage is now complete. Check carefully for short circuits and poor solder connections. Clean out any clippings or solder splashes that may be present.

- (✓) Install a 150 Ω resistor (brown-green-brown) from socket D2 (NS) to ground lug D9 (NS). Dress between pin D1 and the center post D8.
 - (✓) Connect a .005 μ f disc condenser from socket D2 (S) (2) to socket D7 (S) (2). Keep the leads short, dressing the condenser over the 150 Ω resistor and vertical in respect to chassis.
 - (✓) Bend socket pin D5 and IF transformer pin X3 toward each other and lock in place as before. Solder the junction (1).
 - (✓) Connect a .005 μ f disc condenser from socket D6 (NS) to ground lug D9 (S) (3). Dress flat to chassis. Make sure the solder flows smoothly over all wires connected to D9.
 - (✓) Run a .005 μ f disc condenser from socket D4 (NS) to IF transformer X4 (NS) (use sleeving). Dress close to chassis.
 - (✓) Install a 68 K Ω resistor (blue-gray-orange) from socket D6 (S) (2) to IF transformer X4 (NS). Dress between X2 and X3, keeping the alignment opening clear. The body of the resistor must be close to D6.
 - (✓) Mount a .005 μ f disc condenser from terminal strip U1 (S) (4) to U2 (S) (1). Dress as tight to the strip as possible.
 - (✓) Connect a 2.2 K Ω resistor (red-red-red) from terminal strip V1 (NS) to IF transformer X4 (S) (3).
 - (✓) Connect a 47 Ω resistor (yellow-violet-black) from transformer lug X1 (S) (1) to socket E1 (S) (1).
 - (✓) Run a short bare wire from IF transformer X2 (S) (1) to socket ground lug E9 (NS).
 - (✓) Cut two wires to a length of 2 1/2". Strip and tin all four ends and twist the two wires together. At one end, connect one wire to socket D3 (S) (4) and the other to D4 (S) (3). Bend wires back over the chassis to keep them out of the way.
- The first 6CB6 IF amplifier stage is now complete. Check for short circuits, wire clippings and solder splashes.
- (✓) Connect a 68 Ω resistor (blue-gray-black) from socket E2 (NS) to ground lug E9 (NS). Dress between E1 and center post E8.
 - (✓) Connect a .005 μ f disc condenser from socket E2 (S) (2) to socket E7 (S) (2). Dress above the 68 Ω resistor and vertical in respect to chassis.
 - (✓) Connect socket lug E5 to ratio detector transformer Y3 (S) (1) by bending the pins toward each other and locking in place.
 - (✓) Run a .005 μ f disc condenser from socket E4 (S) (2) to detector transformer Y4 (NS) (use sleeving). Dress close to chassis.
 - (✓) Install a .005 μ f disc condenser from socket E6 (NS) to ground lug E9 (S) (4). Dress close to chassis. Make sure all connections are securely soldered.
 - (✓) Connect a 68 K Ω resistor (blue-gray-orange) from socket E6 (S) (2) to detector transformer Y4 (NS). Dress between Y3 and Y5, leaving the bottom alignment opening clear. The resistor body should rest against Y5.

- (✓) Run a 2.2 K Ω resistor (red-red-red) from terminal strip V1 (S) (3) to detector transformer Y4 (S) (3).
- (✓) Install a 68 Ω resistor (blue-gray-black) from detector transformer Y6 (S) (1) (use sleeving) to terminal strip T3 (NS). Dress close to chassis.
- (✓) Connect a short bare wire from detector transformer Y2 (S) (1) to socket F5 (S) (1).
- (✓) Similarly, connect a bare wire from Y1 (S) (1) to socket F7 (S) (1).

This completes the wiring of the second IF amplifier stage. Check carefully for wiring errors, short circuits, solder splashes and loose clippings. Lug Y5 of the detector transformer is not used and no wires should be attached to or touching this lug.

- (✓) Connect a 270 μ f disc condenser from socket F2 (NS) to terminal strip T3 (NS). Dress close to chassis. See Figure 9.
- (✓) Connect a 270 μ f disc condenser from socket F1 (NS) (use sleeving) to terminal strip T3 (NS). Dress close to chassis.
- (✓) Run a 1500 Ω resistor (brown-green-red) from socket F2 (S) (2) (use sleeving) to terminal strip TT1 (NS) (use sleeving). Dress close to chassis between strip T and TT.
- (✓) Run a 1000 Ω resistor (brown-black-red) from socket F1 (S) (2) (use sleeving) to terminal strip TT3 (NS).
- (✓) Connect a 6.8 K Ω resistor (blue-gray-red) from terminal strip TT2 (NS) to TT3 (NS). Dress between T and TT as shown in Figure 9 and Pictorial 1.

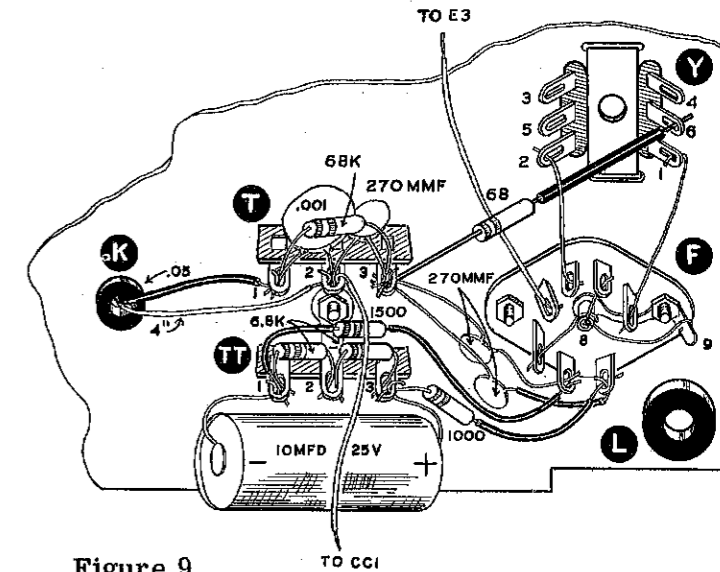

Figure 9

- (✓) Similarly, connect a 6.8 K Ω resistor (blue-gray-red) from terminal strip TT1 (NS) to TT2 (S) (2). Dress as before.
- (✓) Install a 10 μ f 25 volt electrolytic condenser from terminal strip TT1 (NS) to TT3 (S) (3). The positive (+) end connects to TT3. Dress tight to terminal strip TT and chassis so that the condenser clears the bottom edge of the chassis. Keep the end connected to TT1 away from ground lug G9.
- (✓) Install a 270 μ f disc condenser from terminal strip T3 (NS) to T2 (NS).
- (✓) Run a .001 μ f disc condenser from terminal strip T1 (NS) to T2 (NS).
- () Cut a wire to a length of 4". Strip and tin both ends and connect one end to terminal strip T2 (NS). Pass the free end through grommet K and leave free.
- () In the same fashion, prepare a wire 2 1/4" long and connect one end to terminal strip T2 (S) (4). Dress the free end straight up or in a direction where it will be out of the way.
- (✓) Connect a 68 K Ω resistor (blue-gray-orange) from terminal strip T3 (S) (5) to T1 (NS).
- (✓) Cut one lead of a .05 μ f 400 volt tubular condenser to a length of 1 1/2". Slip sleeving over this end and pass through grommet K from the top of the chassis. Connect the end appearing through K at the bottom to terminal strip T1 (NS). On top of the chassis, bend the condenser body over toward socket F.
- () In the same fashion, cut one lead of the remaining .05 μ f 400 volt tubular condenser to a length of 1 1/2", install sleeving and pass through grommet K from the top of the chassis. Connect the end appearing through K at the chassis bottom to socket G5 (NS). On top of the chassis, bend the body of the condenser toward socket B.

This completes the wiring of the 6AL5 ratio detector stage. Carefully check for short circuits, clippings and solder splashes.

- (✓) Connect a 1 KΩ resistor (brown-black-red) from socket G7 (S) (1) to ground lug G9 (NS). Keep the end connected to G9 clear of the negative lead of the electrolytic condenser connected to TT1.
- * () Install a 1 megohm resistor (brown-black-green) from socket G6 (NS) to ground lug G9(S) (3), observing the same precautions mentioned in the previous step.
- * () Run a 47 KΩ resistor (yellow-violet-orange) from terminal strip S1 (S) (3) (use sleeving) to socket G5 (S) (2).
- (✓) Install a .01 μfd disc condenser from terminal strip S2 (S) (1) to S3 (NS).
- (✓) Run a 330 KΩ resistor (orange-orange-yellow) from terminal strip S3 (S) (4) (use sleeving) to terminal strip TT1 (S) (4) (use sleeving).

This completes wiring of the chassis part of the audio amplifier and the AGC line. The chassis is also complete. Clean out clippings and solder splashes and carefully check the entire chassis for short circuits. Compare the chassis against Pictorial 1, looking for errors in wiring. A little time spent at this point may save a considerable amount of trouble upon completion of the kit. If any wires or component leads appear longer than they absolutely have to be, it will be worthwhile to shorten them. Several points will be found not soldered when checking. Do not solder A3, A4, T1 or G6.

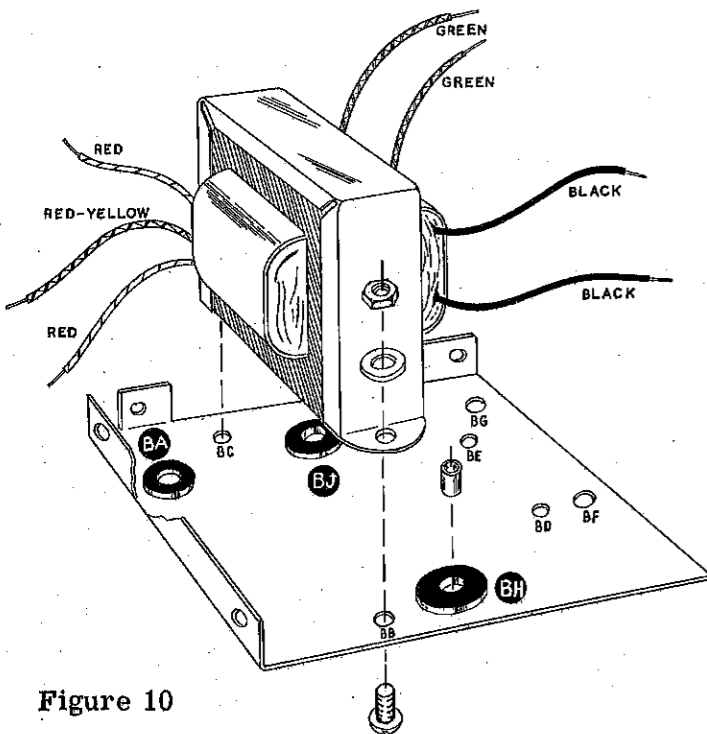

Figure 10

- (✓) Identify the left end bracket B, which is plain aluminum with bends on the bottom and one end only. See Figure 10. Install a 3/8" grommet at location BA.
- (✓) Install large diameter 7/16" soft rubber grommets at locations BH and BJ.
- (✓) Insert a 3/16" metal spacer in the center of each large grommet as shown in Figure 11.

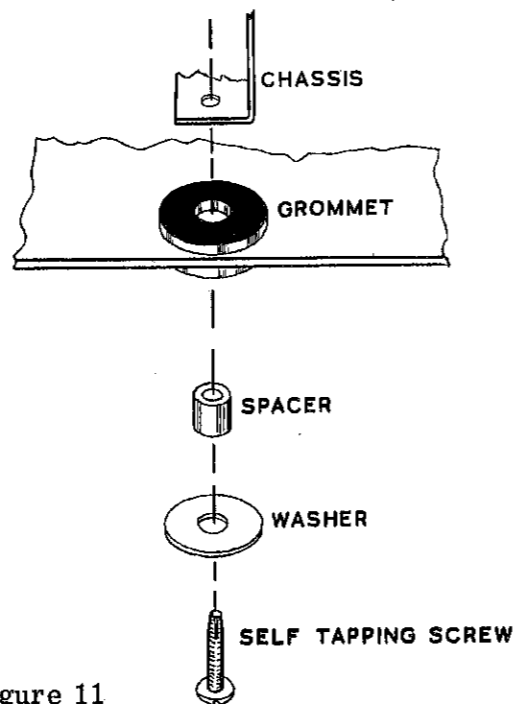

Figure 11

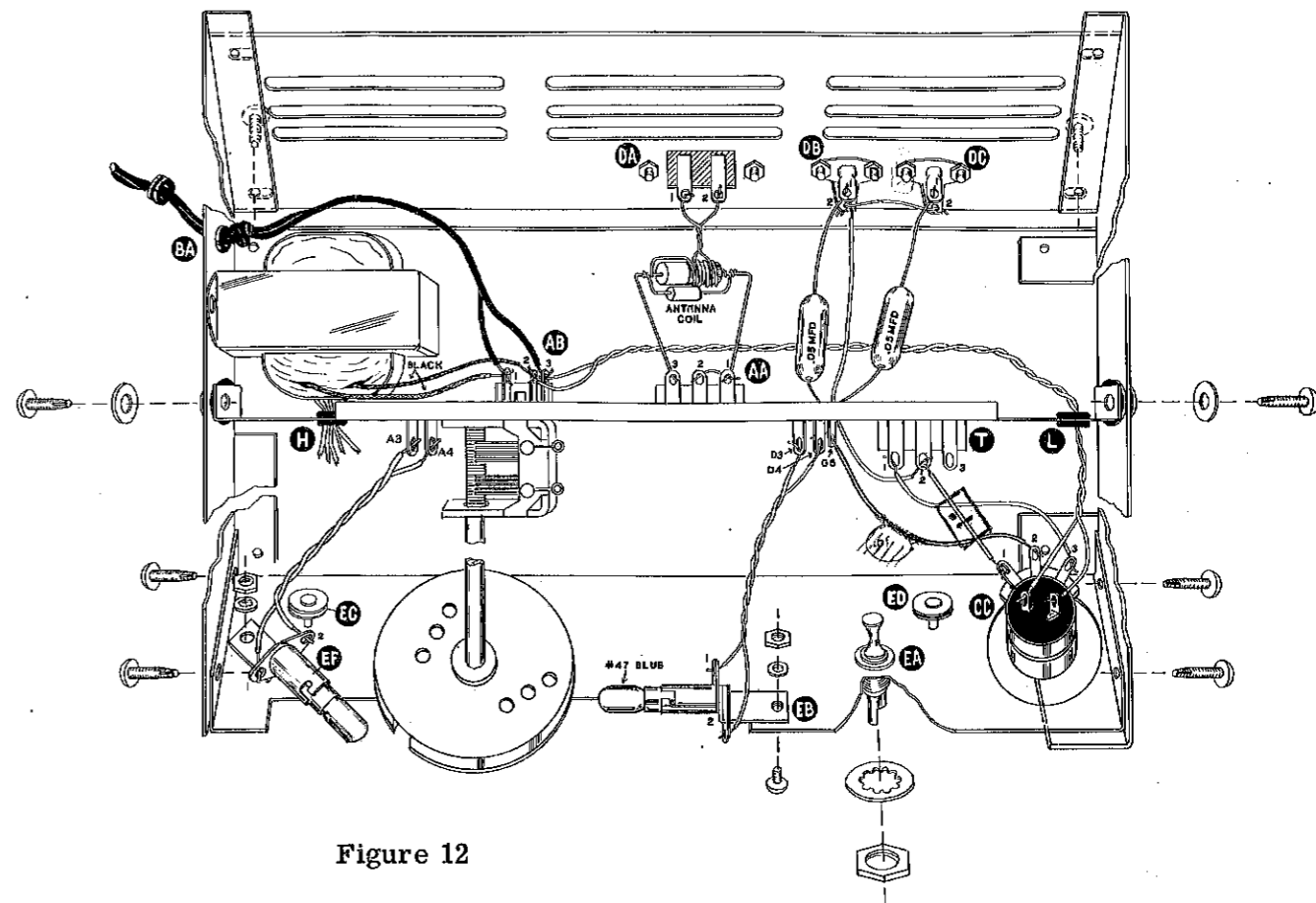

Figure 12

- (✓) Using the two heavy 8-32 screws, mount the power transformer on the left bracket, placing #8 lockwashers under the nuts. Note that the screws are inserted outside the bracket through holes BB and BC and the lockwashers and nuts are on the transformer side. The red and red-yellow leads should be nearest grommet BA.
- (✓) Mount bracket B on the left or tuning condenser end of the chassis, with the transformer fitting over the chassis top as shown in Figure 12. Place a 9/16" washer on a 6-32 self-tapping screw and insert through the spacer previously installed in grommet BH. Line the screw up with the top chassis opening and secure the assembly. Before completely tightening the screw, start the second self-tapping screw and washer through the bottom opening BJ. Now tighten both screws.
- (✓) Install two 7/16" grommets in the large openings in the right hand bracket and insert the 3/16" metal spacers in each grommet. Install the bracket on the right hand end of the chassis in the same fashion. The large hole should be forward. See Figure 12.
- (✓) Place the red, red-yellow and green power transformer leads through grommet H on the chassis. Cut one green lead to length sufficient to reach socket A3, strip and tin the lead and connect it to A3 (NS).
- (✓) In the same fashion, connect the remaining green lead to socket A4 (NS).
- (✓) Cut two wires to a length of 3 1/2". Strip all four ends and twist together. At one end of the twisted pair, connect one lead to socket A3 (S) (3) and the other to A4 (S) (3).
- (✓) Connect the red-yellow lead to terminal strip M2 (S) (1).
- (✓) Connect a red lead to socket A1 (S) (1). Dress over the socket to keep this lead above the chassis edge.
- (✓) In the same manner, connect the remaining red lead to socket A6 (S) (1).
- (✓) On top of the chassis, connect one black transformer lead to terminal strip AB1 (NS). See Pictorial 2.
- (✓) Connect the remaining black lead to terminal strip AB2 (NS).

- (✓) Install an 8-32 set screw in the bushing and mount the large condenser drive pulley on the tuning condenser shaft with the bushing away from the condenser frame. With the condenser plates fully meshed, orient the opening in the outer edge of the pulley so that it is toward ground lug N on the chassis. The edge of the pulley must be flush with the end of the tuning condenser shaft when the set screw is tightened.
- (✓) Mount pilot lamp socket EF on the dial plate with 6-32 hardware. Observe Figure 12 and 17.

- (✓) Mount the dial plate as shown in Figure 12, with the long cut-out facing upward. Secure with 6-32 self tapping screws in the four foremost holes in the end brackets.

- () Prepare the volume control CC as shown in Figure 13. Slip sleeving over one lead of a .01 μ fd disc condenser and connect this lead to CC2 (S) (1). Do not cut away any of the leads.

- () Cut a wire to a length of 3", strip and tin both ends and connect one end to CC3 (S) (1).

- () Cut two wires to a length of 11". Hold an end of each wire evenly together and twist the pair together up to approximately 1" from each end. Strip and tin all four ends.

- () At one end of this cable, connect one lead to control switch terminal CC4 (S) (1) and the remaining free end to CC5 (S) (1).

- () Place a large lockwasher over the control shaft and temporarily install the control through the openings provided in the dial plate and right end bracket. See Figure 14. Tighten the control in place with lugs 1, 2 and 3 pointing straight down over socket F.

- () Pass the twisted leads from CC4 and CC5 through chassis grommet L and dress along the center of the chassis as shown in Pictorial 2. Connect one lead to terminal strip AB2 (S) (2) and the remaining lead to AB3 (NS).

- () Run the free end of the lead connected to terminal strip T2 to control lug CC1 (S) (1).

- () Pass sleeving over the free lead of the .01 μ fd disc condenser connected to CC2 and connect this end to socket G6 (S) (2).

- () Connect the lead from CC3 to terminal strip T1 (S) (4).

- () Slip a 3/8" rubber grommet over the line cord and pass the cord through grommet BA in the left end bracket from the outside. DO NOT forget the grommet on the line cord. Tie a knot approximately 5" from the end for strain relief. Connect one line cord lead to terminal strip AB1 (S) (2) and the remaining lead to AB3 (S) (2).

- () Identify the antenna coil, which is wound on a 2 watt resistor and has a 10 μ fd condenser connected across the resistor. Cut both of the resistor leads to a length of 1 1/4". DO NOT cut the twisted leads. Note that the coil with the twisted leads is nearer one end of the resistor. Connect this end to terminal strip AA1 (S) (2), which is the grounded end, and the end furthest from the coil to AA3 (S) (2). The coil assembly must stand straight up, vertical in respect to the chassis, with the twisted leads in line, also vertical to the chassis.

- (✓) Mount the 2-lug screw type terminal strip at location DA on the back panel with 6-32 hardware. Note that the strip mounts on the outside, or painted side of the panel as shown in Figure 15 on Page 23.

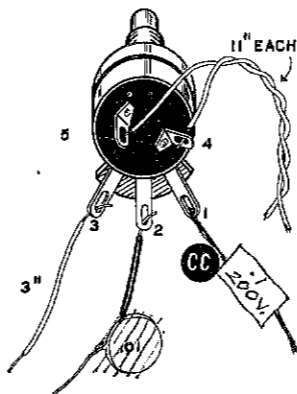

Figure 13

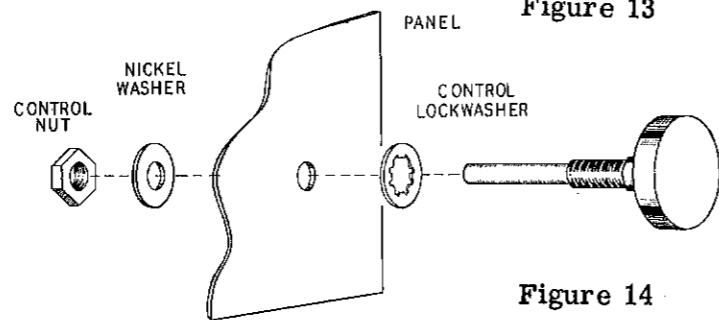

Figure 14

HOW TO MOUNT CONTROLS & SWITCHES.

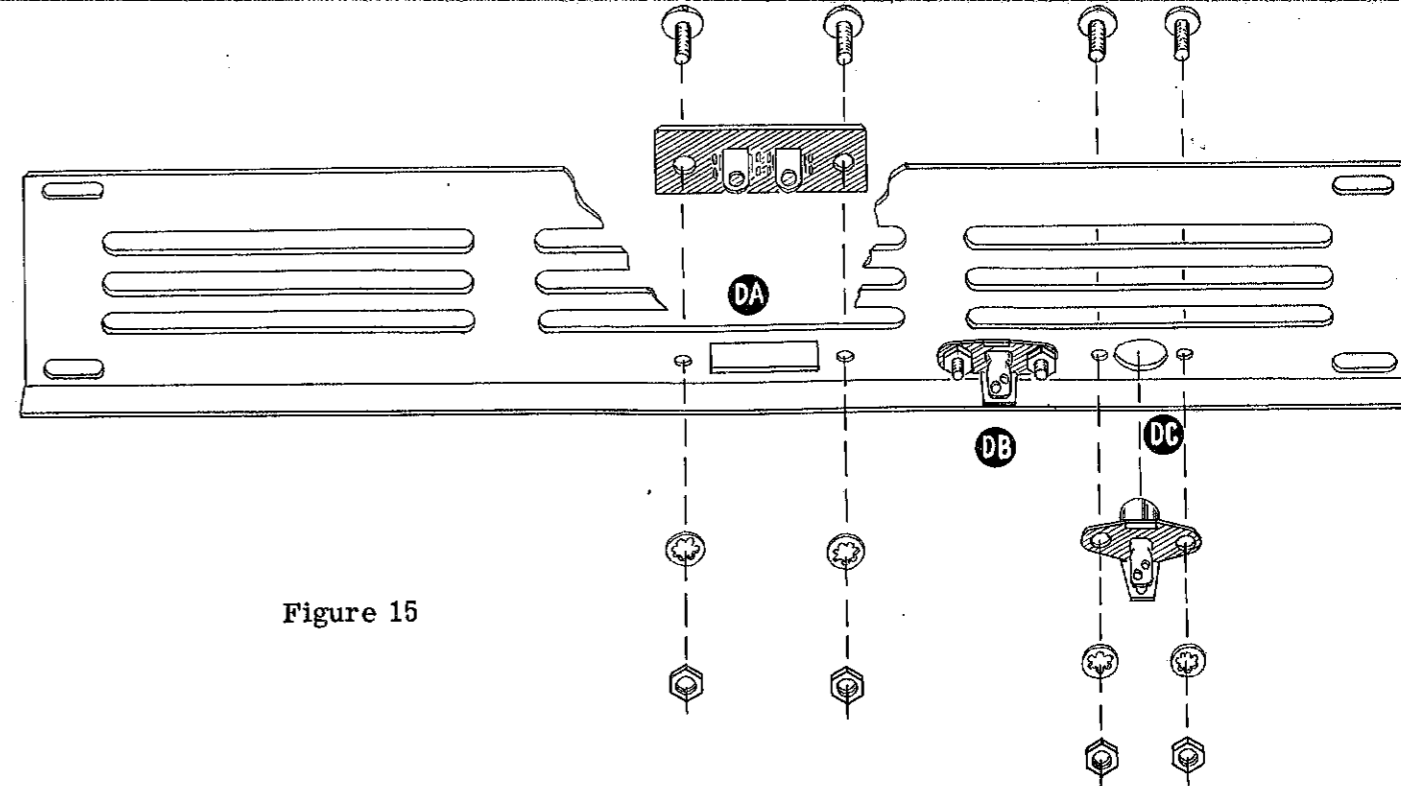

Figure 15

- (✓) Install a phono connector at DB on the rear panel with 6-32 hardware. Note that these connectors are installed inside the panel as shown in Figure 15. The ground lug should be nearest the panel flange.

- (✓) In the same manner, install a phono connector at DC.

- () Install the back plate with the bent flange to the bottom. Use 6-32 self-tapping screws in the bottom holes at each end only, as shown in Figure 12.

- () Connect one of the twisted leads of the antenna coil to terminal strip DA1 (S) (1) and the remaining lead to DA2 (S) (1).

- () Connect a bare wire from connector ground lug DB2 (NS) to connector ground lug DC2 (S) (1).

- () Connect the insulated wire appearing through chassis grommet K to connector ground lug DB2 (S) (2).

- () Connect the free lead of the .05 μ fd 400 volt condenser previously bent toward socket B to connector DB1 (S) (1).

- () Connect the free lead of the remaining .05 μ fd 400 volt condenser to connector DC1 (S) (1).

- () Mount pilot lamp socket EB with 6-32 hardware on the dial plate. The screw goes through the small hole near the center of the dial plate, the socket, a lockwasher and nut. The socket is oriented parallel with the dial plate edge toward the tuning condenser. If alignment of the set is intended upon completion, the socket may be moved upward temporarily to clear the alignment opening in the dial plate.

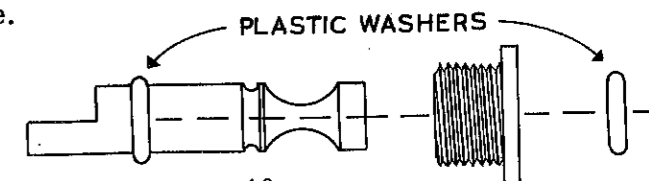

Figure 16

- (✓) Assemble the dial drive shaft assembly as shown in Figure 16. Begin by pushing one of the plastic "O" washers on the shaft from the flatted end until it falls in place in the slot provided for it. Do not use tools with sharp edges to force the washer over the edge of the flat, for it is possible that the washer will be broken. After the first washer is in place, put a small amount of lubriplate or vaseline on the shaft. Do not use an excessive amount since it may cause dial cord slippage. Install the bushing in the direction shown in Figure 16 and install the other plastic washer from the drive side of the shaft. A spare washer is furnished in case of accidental damage during installation.

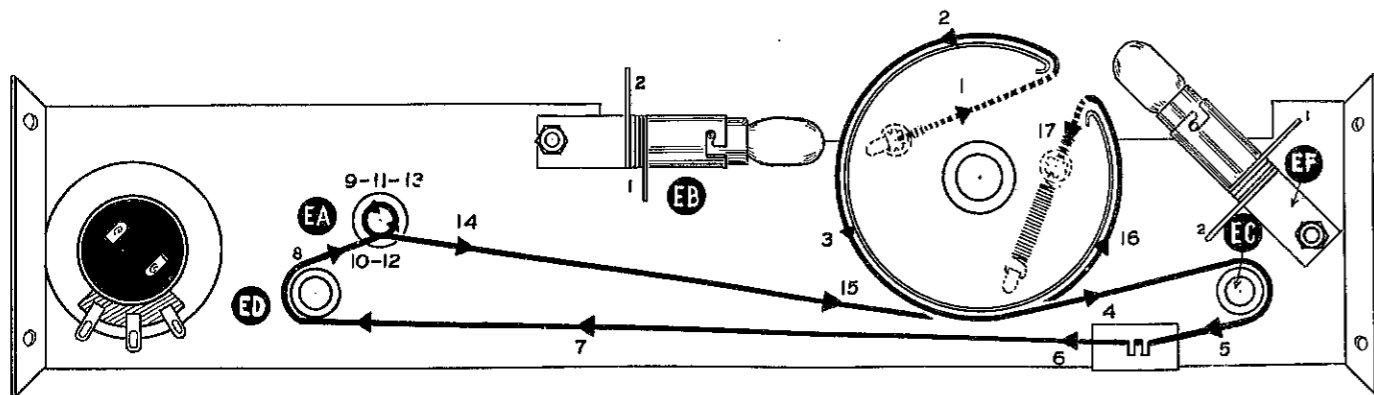

Figure 17

- (✓) Mount the drive shaft assembly through the dial plate from the rear at location EA. Refer to Figure 12 and note that the bushing goes through the dial plate, a large lockwasher and a control nut. Tighten securely.
- () Identify the two wires previously connected to socket D3 and D4. Connect one wire to pilot light socket EB1 (S) (1) and the other to EB2 (S) (1).
- () Identify the two wires previously connected to socket A3 and A4. Connect one wire to pilot light socket EF1 (S) (1) and the other to EF2 (S) (1).
- (✓) Observe Figure 17 and install the dial cord assembly. Begin by hooking one of the eyelets over the ear provided on the tuning drum. Run the cord counterclockwise around the pulley (looking from the back of the tuner), around idler pulley EC, across the dial plate to idler pulley ED, around drive shaft EA 3 turns and back to the bottom side of the drum. Bring the cord counterclockwise around the drum and through the opening. Hook the dial cord spring on the remaining ear on the drum and the other end of the spring to the eyelet on the dial cord.
- () Install the dial pointer up from the bottom of the dial plate. Spread the 3 prongs and place the dial cord between them. Temporarily install the front panel as outlined on pages 28 and 29. With the tuning condenser fully closed, set the pointer under the mark to the left of "88" of the dial. Pinch the lugs together to secure the pointer in place, taking care not to cut the cord. Turn the tuning control through its entire range to make sure everything operates properly. Remove the panel if alignment is intended. Otherwise the panel can be left in place.

NOTE: Six feet of audio cable is furnished with the kit and this should be sufficient for the average installation. It is always good practice to mount the various components of a high fidelity installation as close together as feasible, with the exception of the speaker system. Long audio cables between components cause loss of high frequency response unless the output impedance is very low. The output impedance at the fixed level jack is 47 K Ω , which is relatively high. RG58A/U cable, furnished with the kit, has a capacity of approximately 28.5 $\mu\mu\text{f}$ per foot, or 171 $\mu\mu\text{f}$ for the entire 6' length. This capacity will cause the output to be down 6 db at 20,000 cycles, so longer cable cannot be used at the fixed output, unless the cable has lower capacity. If it is possible to use a shorter length, by all means do so, since the high frequency performance will be improved. Refer to the "Outputs" section under INSTALLATION in this manual.

Output impedance at the variable output is approximately 15 K Ω and losses will be considerably less for a given amount of cable. The response will be down 6 db at 20,000 cycles with 175 feet of RG58A/U and nearly perfectly flat with cable lengths of 100 feet or less, although hum can become a serious problem with such extreme lengths. The cable length should be just long enough to meet the requirements of the installation for best performance.

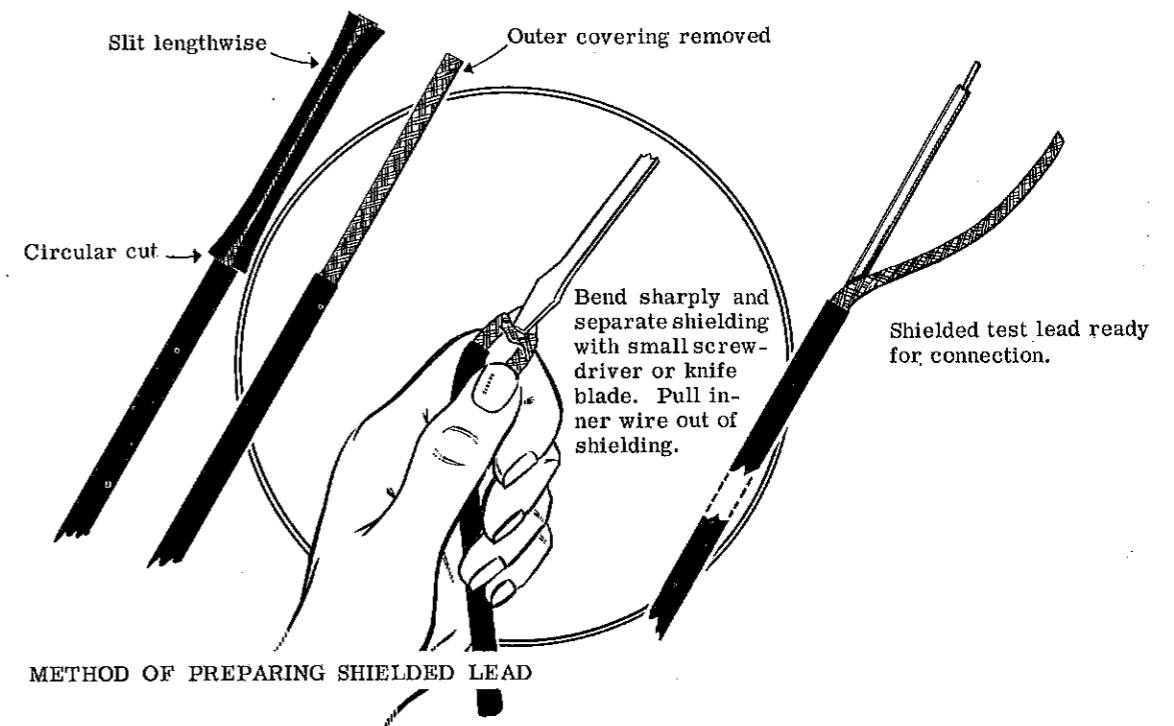

Figure 18

- () Prepare the audio cable. Strip approximately 1" of outer rubber insulation from each end of the cable. At each end, bend the exposed shielding braid over and make an opening in it with a sharp pointed tool of some kind, such as an ice pick. Pull the insulated inner conductor through and strip away approximately 5/8" of insulation. Check with Figure 18.
- () Install the phono connectors on each end of the cable as shown in Figure 19. Insert the prepared inner conductor through the back of the connector until it will go no further. A small amount of wire should show at the tip of the connector. Solder the wire to the connector at this point. Next, wrap the shield braid around the plug shell and solder securely. Repeat the operation for the opposite end of the cable, unless the audio equipment to be used with the tuner uses some other type of connector.

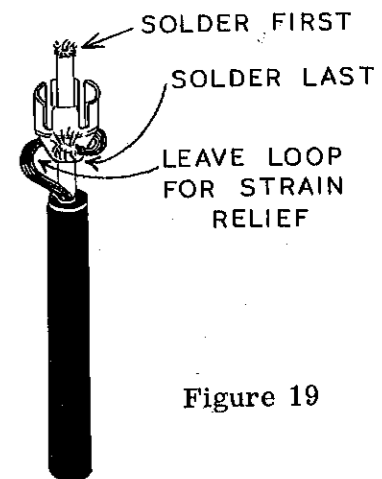

Figure 19

IMPORTANT WARNING: MINIATURE TUBES CAN BE EASILY DAMAGED WHEN INSTALLING THEM IN THEIR SOCKETS. THEREFORE, USE EXTREME CARE WHEN INSTALLING THESE TUBES. WE DO NOT GUARANTEE OR REPLACE MINIATURE TUBES BROKEN DURING INSTALLATION.

- () Insert the 6BQ7A tube in socket B, a 6U8 at C, a 6CB6 at D, a 6CB6 at E, a 6AL5 at F and a 6C4 at G. Do not install the 6X4 in socket A yet. Place the #47 bulbs in the pilot lamp sockets. Slip a 1" long piece of large diameter sleeving over each pilot lamp socket. Push down as far as it will go.

NOTE: At no time should the tuner be operated without the 6C4 or 6U8 tube in its socket. Plate current drawn by these tubes reduces the voltage across the 20 μf d decoupling condenser-resistor network to a level within the operating limits of the condenser. If either tube is removed, the high voltage may exceed the condenser rating, causing breakdown. When checking the tubes, turn the receiver off until replacement is made.

This completes construction of the tuner. The unit should now be tested before the front panel, and top and bottom covers are installed.

TESTING THE COMPLETED TUNER

Before connecting the receiver to the AC outlet, check the following points:

1. Be sure the 6X4 rectifier is not in its socket.
2. If an ohmmeter is available, check the DC resistance from terminal strip M3 to ground. The reading should be at least 100,000 Ω after 15 seconds. If considerably lower, carefully recheck the wiring for an error or short circuit. If everything appears to be all right, try removing the tubes one at a time to see if the short will disappear. If it does, the tube may be shorted or an error may exist at the tube socket. If this procedure fails to help, it will be necessary to disconnect the high voltage wires one at a time until the short circuit disappears to isolate the source of trouble.
3. Be sure the switch is off by rotating the volume control to its full counterclockwise position.

Connect the line cord to a 110 to 125 volt 50/60 cycles AC outlet. **DO NOT CONNECT THE TUNER TO A DC (DIRECT CURRENT) LINE. SERIOUS DAMAGE TO THE POWER TRANSFORMER WILL RESULT.** No attempt should be made to use this unit on 25 cycle AC lines, since the transformer may be seriously damaged and the receiver will not operate.

Turn the receiver on by rotating the volume control clockwise until a click is heard. The filaments of the 6BQ7A, 6U8, the two 6CB6's, 6AL5 and the 6C4 should show a red color and the pilot lamp should light. Now insert the 6X4 rectifier tube in socket A. This tube should also show filament color. If the 6X4 plates show a red color or if the tube shows a bright violet glow internally, turn the tuner off immediately and recheck the wiring for an error. Any such action indicates that excessive current is being drawn from the power supply.

High current can be caused by errors or shorts in the wiring or by a defective tube. The procedure described under Step 2 above will help locate the source of difficulty.

NOTE: The tubes in the tuner normally become quite hot due to the relatively large amount of current drawn through them. This characteristic is typical of all tubes where the plate current is relatively high and does not indicate that anything is wrong with the tuner.

Connect one end of the audio cable previously prepared to the output nearest to the antenna terminals at the rear of the tuner. Connect the opposite end to the input of the amplifier or preamplifier to be used. Advance the volume control to the full clockwise position. A fairly loud "hiss" should be heard from the speaker system. If the volume control has no effect on the level of the noise, the condensers connected to the two output connectors may have been accidentally interchanged. Corrective measures are not necessary, connect the cable to the outside audio output instead. Rotate the tuning control over its entire range. The sound produced by the speaker should change somewhat. Strong local FM stations may be heard. If the receiver will operate in this manner, it may be assumed that it is operating properly. In case of improper performance, follow the procedures outlined under **IN CASE OF DIFFICULTY**.

ALIGNMENT OF THE TUNER

After alignment is completed, or if it is intended that the tuner be aligned at a later date, it is suggested that the alignment tool be taped to the inside surface of the back panel near the bottom so that it will not be misplaced. Masking tape, transparent tape or even adhesive tape will do. The tool is not generally useful since it is designed for a specific type of transformer.

If the receiver functions satisfactorily when first tested with an antenna connected, the steps under **ALIGNMENT OF THE TUNER** can be omitted and final assembly completed as per instructions. Best "fringe area" performance will be obtained by aligning the receiver, following the subsequent instructions.

The tuning assembly, the IF transformers and the ratio detector transformer are pre-aligned at the factory against standards developed during design and testing of the tuner. In general, this alignment will be satisfactory if the tuner is to be operated in an area where there are a number of strong stations. If most of the stations are quite distant from the listening point, it will probably be advisable to go through the following alignment procedure to get the highest possible sensitivity from the tuner, unless the performance is satisfactory when tested with the antenna system connected to the tuner. Perfect pre-alignment is practically impossible due to the critical nature of electronic circuits at very high frequencies. Things such as variance in wiring capacity, tube capacity and lead lengths, as well as handling of the parts will all tend to detune the circuit to some extent.

To align the receiver, connect the ground lead of a signal generator to terminal strip U2, which is grounded to chassis. Connect the output or "hot" lead of the signal generator through a .01 μ fd condenser to pin 1 of socket D (the first 6CB6 socket). The generator should be connected with the receiver turned off, for it will be necessary to work in close quarters near several high voltage points. Special precautions should be taken near terminal strips U1 and V1, since high voltage is present at both points. Connect the ground lead of a vacuum tube voltmeter or a 20,000 Ω per volt meter to chassis near 6C4 socket G and the meter input lead to terminal strip TT1. Set the meter to read DC-, for the output voltage is negative at this point. Set the meter range switch to the 1 1/2 or 3 volt range, depending on the type of meter and turn on the tuner. Allow a few minutes for warmup and then adjust the signal generator output to give a reading of approximately 1 volt. The generator frequency must be 10.7 megacycles (mc).

Observe the alignment tool furnished with the kit carefully. Note that the two ends are different, one having a shoulder to limit the insertion travel of the tool and the other end having a small diameter shank behind the hexagonal drive. The end with the small diameter shank may be used to align each of the slugs in each transformer from one end of the transformer but this is not recommended unless the operator is thoroughly familiar with alignment procedures. Possibility of misalignment will be avoided by using the end with a shoulder at the top and bottom of each transformer, since it is impossible to turn both slugs at once with this end.

Reference to the top slug indicates that the adjustment is made on the core nearest the back of the tuner. The bottom slug is the core nearest the chassis.

Alignment is started by adjusting the bottom slug of ratio detector transformer Y for maximum indication of the meter. (**IMPORTANT:** Always decrease the output of the signal generator to maintain a constant reference reading on the meter, rather than changing the range setting of the meter.) **DO NOT** touch the top slug of the ratio detector transformer at this time. Next, adjust the top and bottom slugs of the second IF transformer X for maximum indication, reducing the generator output as alignment proceeds.

Turn the tuner off and disconnect the hot lead of the signal generator from pin 1 of socket D. Leave the ground lead connected to terminal strip U2 and connect the generator output through the .01 μ fd condenser to pin 2 of socket C, the 6U8 stage. Turn the receiver on and reduce the generator output to read approximately the same on the meter as before and adjust the top and bottom slugs of IF transformer W for maximum output, reducing generator output as necessary. **NOTE:** An extremely high gain IF system is used in the Heathkit FM-3A Tuner and most generators have enough leakage at 10.7 megacycles to cause some reading to be evident with the generator output turned all of the way down. If the lowest output reading obtainable is still considerably above the level used as a starting reference, leave the signal generator output at minimum and increase the range setting of the meter as necessary.

IF alignment is completed by removing the meter input lead from terminal strip TT1 and connecting it to terminal strip T1. Leave ground lead connected to ground. Set the meter to highest sensitivity range and adjust the top slug of ratio detector transformer Y for zero output voltage. Move the alignment tool back and forth a few times to make sure that the meter swings both sides of the zero mark. If not, turn the core further in or out until a + or - swing can be obtained when the core is moved in either direction from the zero output point. Disconnect all leads from the tuner. Orient the pilot lamp socket parallel with the dial plate edge if it was moved.

Alignment of the tuning assembly should not be attempted unless there is conclusive evidence of misalignment. Since most signal generators do not cover the frequency range of 88 to 108 megacycles, it will probably be necessary to use FM stations of known frequency as a signal source. An antenna should be connected to the antenna terminals or if a high frequency signal generator is available, connect the output to the antenna terminals. Connect a voltmeter to ground and terminal strip TT1 as before. Tune in a station near 106 mc or set the signal generator and tuner dial to 106 mc and carefully adjust the RF trimmer (nearest the dial drum) for maximum indication on the meter. Adjust very slowly, for the adjustment is critical. Rock the dial back and forth while adjusting the trimmer in order to find the highest peak response. The oscillator trimmer, nearest the chassis, should not be touched unless the calibration is off badly. If this should be the case, tune to a station known to be near 106 mc. Turn the tuning knob to set the pointer to a point nearer the proper frequency mark on the dial, but keep the signal tuned in well enough to cause an indication on the meter. Carefully adjust the oscillator trimmer for maximum indication and repeat the procedure until proper frequency calibration is obtained. The same procedure should be observed if a signal generator is used. After oscillator adjustments are completed, the RF trimmer should be readjusted as described above. Alignment of the FM-3A Tuner is now complete.

FINAL ASSEMBLY OF THE TUNER

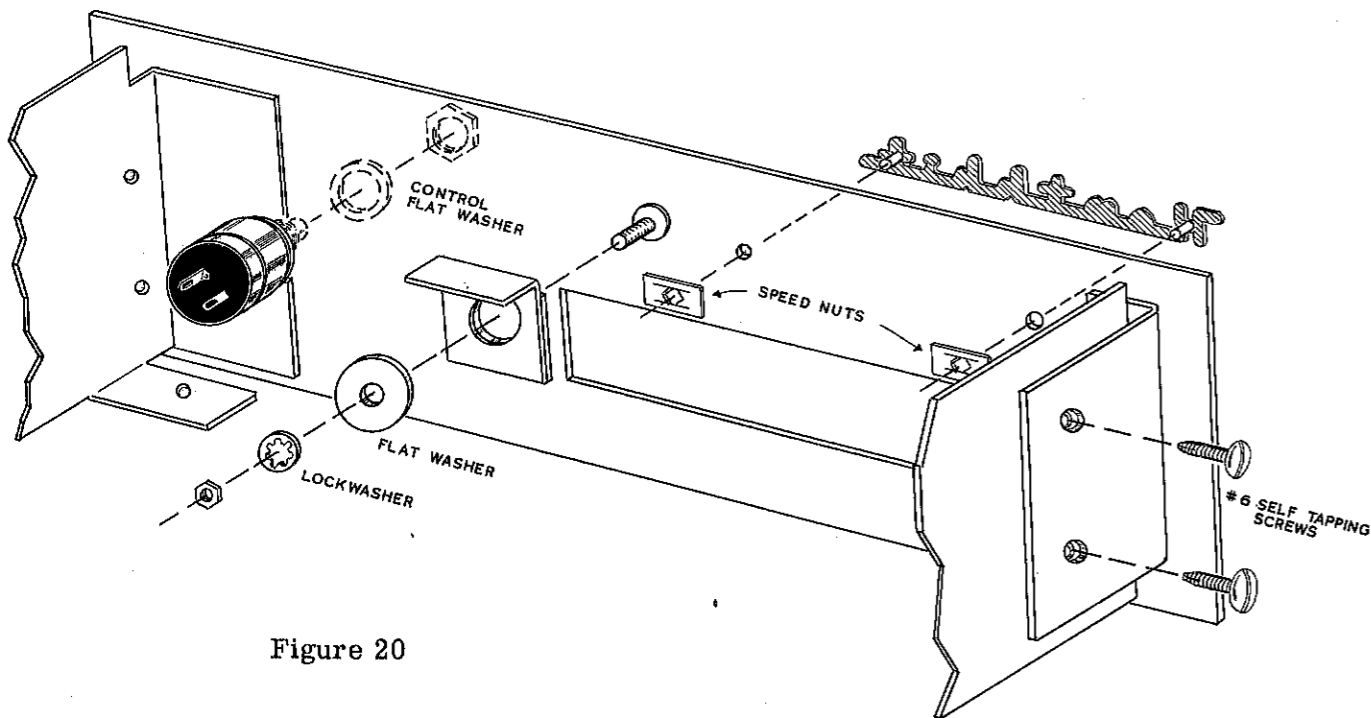

Figure 20

- () Place the panel reinforcing bracket over the stud at the center of the front panel, as shown in Figure 20. The stud goes through the bracket, a large 9/16" flat metal washer, a lock-washer and nut. Tighten in place with the bracket flange slightly below and parallel with the top of the panel. Note: Avoid bending the front panel during construction and installation of the tuner, for the glass will crack under excessive strain.
- (✓) Mount the HEATHKIT nameplate on the front panel. Insert the pins through the small holes in the upper left corner of the panel. Push a spring steel speednut down over each pin from the back of the panel. The long side of each speednut must be parallel with the top of the panel. Cut off excess length of each pin.
- () Make sure the tuner is disconnected from the power outlet and remove the nut holding the volume control in place on the right bracket. Hold the control firmly in place and slip the right hand opening in the panel over the control shaft. Place the control flat washer over the shaft and secure with the nut. Do not tighten yet.

- () At the left end, secure the panel with a 6-32 self-tapping screw through each elongated hole in the front panel bracket, after lining these holes up with the ones in the left chassis bracket. Leave the screws slightly loose.
- () Bend both pilot lamp brackets forward until the bulbs almost touch the front panel.
- () Observe Figure 21 and install the four rubber feet in the four large holes provided in the bottom cover. Insert from the painted side of the cover.
- () With the cooling vents to the rear, install the bottom cover as shown in Figure 22, using 6-32 self-tapping screws at each dimpled opening.

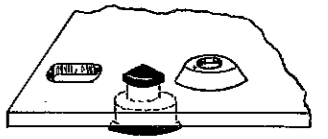

Figure 21

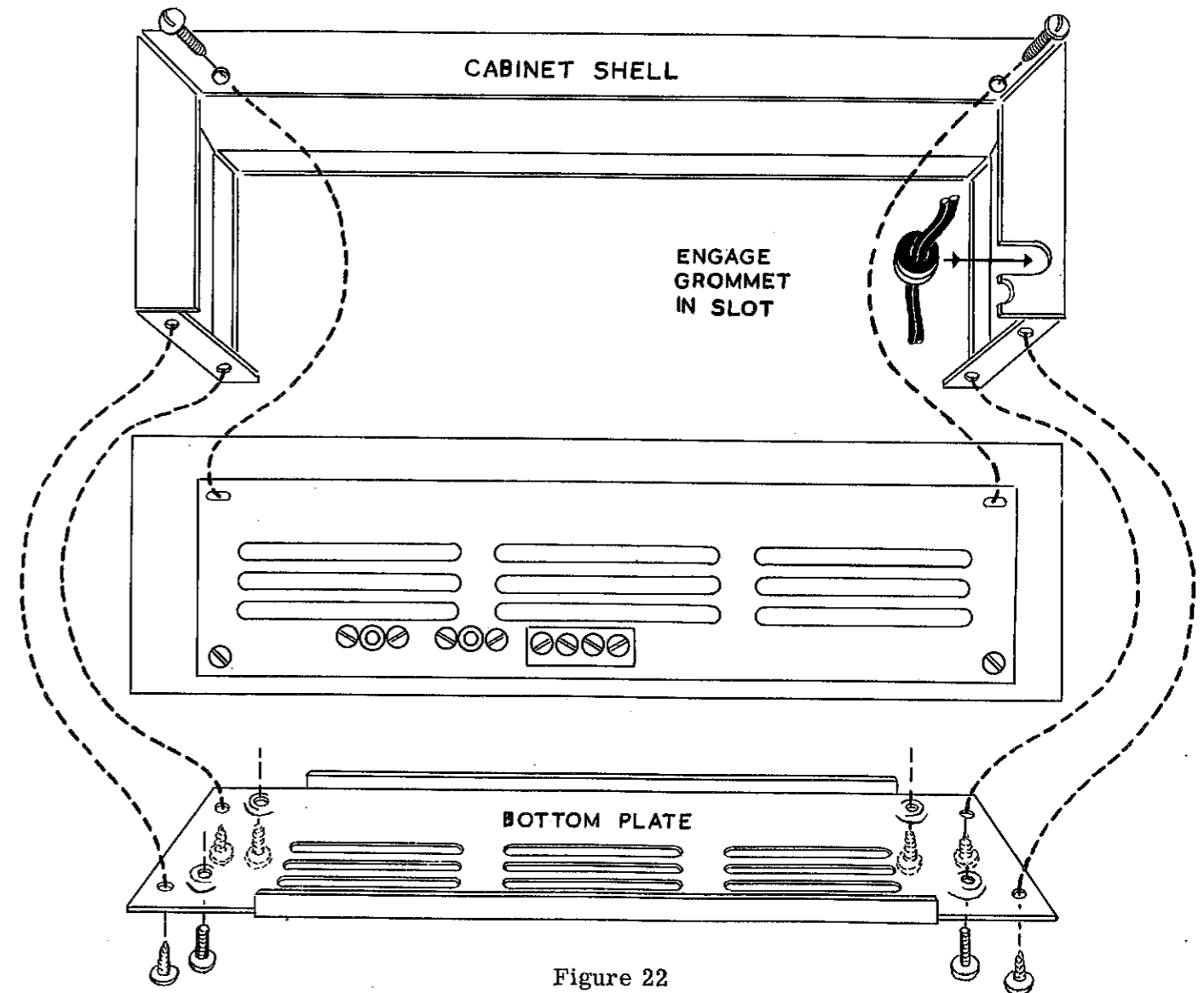

Figure 22

- () Align the bottom cover so that the bottom edge is just flush with the bottom edge of the panel and tighten the control nut and the self-tapping screws at the left end. Inspect the assembly from the top to make sure none of the electrical components mounted on the chassis are touching the bottom cover.
- () Slip the knobs on the control shafts. The knobs push on the flatted shafts, after proper alignment between the flat and the spring insert in the knob. If necessary, loosen the volume control nut to secure proper relationship between the knob indicator line and the panel markings. Then retighten the nut.

- () Install the top cover. Before sliding in place, engage the free grommet previously installed on the line cord in the slot provided at one end of the cover. Engage the front lip of the cover with the panel clamp as shown in Figures 20 and 22 and let the cover down until the bottom flanges rest on the bottom cover. Fasten in place by inserting two 6-32 self-tapping screws through the two small holes in the top rear flange of the shell. These screws will pass through slots in the rear panel and thread into the end brackets.
- () Turn the tuner upside down and fasten the top shell to the bottom cover with #6 sheet metal screws through each of the four elongated slots provided. Before tightening the sheet metal screws, make sure the top shell sides are parallel with the edges of the front panel. If necessary, adjust the cover and tighten the screws.

The tuner is now ready to place in service.

IN CASE OF DIFFICULTY

1. Recheck the wiring. Trace each lead in colored pencil on the pictorial as it is followed in the receiver. Most cases of difficulty result from wrong connections or poorly soldered joints. Often having a friend check the wiring will reveal a mistake consistently overlooked.
2. If possible, compare tube socket voltages with those shown in the table. The readings should be within 20% of those tabulated if a vacuum tube voltmeter is used. Other type meters may give lower readings, due to loading effects. If the voltage fails to compare with the value shown, check further into the circuit involved by checking the various components (resistors, condensers, tubes, etc.).

SOCKET TUBE TYPE	Pin 1	Pin 2	Pin 3	Pin 4	Pin 5	Pin 6	Pin 7	Pin 8	Pin 9
A 6X4	190-230 AC ₁₆₅	NC	0	6.3AC	210 195	190-230 AC ₁₆₅	250 235		
B *6BQ7A	75 80	0.1-0.5 Neg. ₃₆	0.5-0.2 28	0	6.3AC	150 150	55 57	75 80	0
C 6U8	110 80	2 Neg. _{2.5}	85 70	6.3AC	0	180 160	0	0	3-6 Neg. 2-2.5
D 6CB6	0.1-0.5 Neg. ₃₆	1.1 106	6.3AC	0	200 175	95 77	0		
E 6CB6	0	0.6 .57	6.3AC	0	200 175	70 46	0		
F *6AL5	0.5-1.5 .3	0.5-1.5 Neg. ₃	0	6.3AC	0.1-1± 0	0	0.1-1± 0		
G 6C4	55 104	NC	0	6.3AC	55	0	1.8 2.8		

A --- 5V.

C --- OK

All readings taken with a Heathkit vacuum tube voltmeter. All readings are DC voltages measured to chassis, unless otherwise specified. The antenna must be disconnected and the dial set to 108 mc.

NC - no external connection to this contact.

Line voltage - 115 volts 60 cycles.

*Socket voltages for the 6BQ7A and 6AL5 are subject to wide variation. Voltage at pins 1, 2, 3, 7 and 8 of the 6BQ7A will vary due to different tube characteristics, for the two halves of the tube are connected in series. Also, the voltages will vary depending on the AGC voltage at pin 2, which in turn is dependent on the dial setting.

The 6AL5 readings will vary depending on dial setting. It is important that readings on this tube be taken with no signal tuned in. Different tuners will also tend to give varying amounts of residual AGC voltage for the same dial setting. Voltages substantially above those shown in the voltage chart may be indicative of oscillation, especially if the voltage remains high regardless of dial setting. In this case, follow the instructions under OSCILLATION which follow.

Some common types of troubles are listed below along with simple trouble-shooting procedures which are often helpful in locating the source of difficulty.

TUNER COMPLETELY INOPERATIVE: If no sound of any kind is evident when the volume control is turned fully clockwise with the output connected to an amplifier and an antenna connected to the input, check the 6X4 rectifier tube visually once again to be sure that the plates are not red. When sure that everything is all right at this point, check the interconnecting audio cable for short circuits between the shell of the plug and the inner conductor at both ends (an ohm-meter check is recommended) and make sure the connection is secure at both ends.

A screwdriver is a useful tool for making simple disturbance tests. If a stage in the tuner is operating normally, a sound will be heard in the speaker when the grid of an operating stage is touched by the metal part of the screwdriver. This procedure should be started at the 6C4 stage with the volume control turned fully clockwise. Touch the screwdriver to pin 6 of socket G. A click or hum should be heard in the speaker. If not, check the wiring to this stage once again. If the wiring appears to be correct, check the tube and the audio cable. Check the .05 μ fd condenser connected to pin 5 to make sure it is not open or shorted.

When everything is operating normally in the 6C4 stage, the 6AL5 stage should be checked in the same manner, touching pins 1, 2, 5 and 7. Although a click may not be heard, the characteristic of the noise output, if any, should change. Before assuming the 6AL5 stage is at fault, it would be advisable to check the 6CB6 stage E by touching pin 1. No response of any type will indicate trouble in either of these stages. Follow the procedure outlined above to localize the trouble. Give special attention to soldered connections, for a poor connection could cause the receiver to be inoperative.

The remaining check points in order are 6CB6 stage D pin 1, 6U8 stage C pin 2 and pin 9, and 6BQ7A stage B pins 7 and 2. A gradual increase in response should be noted as the test proceeds toward the input of the tuner. If a point is found where no response is obtained, the defective stage has been isolated and the checking can be concentrated in the area of the stage involved. Response all the way through the tuner but no signal reception may be indicative of serious misalignment of either the IF stages or the tuning condenser assembly. A revue of the alignment procedure previously described is in order in this case.

If a signal generator and VTVM are available, the same procedure can be observed by injecting an AM modulated signal at the points indicated above at the appropriate frequency. Response can be heard in the speaker or the VTVM can be used as an indicator by connecting it between ground and terminal strip TT1. Some response will usually be heard even with an AM signal, due to some frequency modulation effects that are usually present. The use of such instruments is highly recommended, if possible, but the screwdriver disturbance tests will suffice.

OSCILLATION: If the tuner operates, but tends to whistle when a station is tuned in, or very low sensitivity is evident, it is likely that the unit is oscillating. Another indication is a high negative voltage at TT1 when no station is tuned in. Oscillation is usually caused by poor connections or improper lead dress. Shorten all leads as much as possible, dressing them close to the chassis. Resolder any connections about which there may be some doubt. Defective tubes may cause instability and it may be worthwhile to have them checked. If identical types are on hand, try substituting them. Also try exchanging the two 6CB6's in sockets D and E. If possible, check the .001 and .005 μ fd disc bypass condensers for an open condenser will often cause instability. Slight adjustment of the IF transformers will frequently stabilize the tuner, especially when it is unaligned.

HUM AND NOISE: Under some conditions, hum may be encountered when the tuner is connected to the audio system. Usually this can be reduced by reversing the direction of the line cord in its receptacle. This should be tried both for the tuner and the main amplifier. Hum in the high level output only would indicate a defective 6C4 tube or an error in wiring at the 6C4 socket. Hum on both outputs may be caused by improper grounding of the entire installation, unless the hum is tuneable in the receiver. In this case, the 6U8 may be the source of trouble because of 60 cycle frequency modulation of the oscillator, or the 6AL5 may be faulty.

A rushing or hissing noise is normal when the receiver is being tuned between stations. This noise should disappear or quiet down substantially when a station is tuned in, depending on the signal strength. Failure to quiet properly may indicate improper alignment or a poor antenna installation if the tuner is operated in fringe areas. Of course, perfect limiting cannot be expected on very distant stations.

Oscillation can cause excessive noise in the receiver, as can a defective tube. Also, the antenna lead-in can pick up some noise, but this can be reduced by twisting the lead-in approximately one turn for each two feet of 300 Ω ribbon.

EXCESSIVE DRIFT: A small amount of drift will normally be noticed during warm-up of the tuner but it will stabilize quickly. Usually the drift will be noticeable only on weak stations. Continuous drifting is usually caused by a poor connection or defective component in the 6U8 oscillator circuit or possibly even a defective 6U8 tube. The 10 $\mu\mu\text{f}$ N750 condenser connected across the oscillator coil on the tuning assembly is the temperature compensating condenser and any defect in it can cause a substantial amount of drift.

Under certain conditions, the IF stages can drift but this is relatively small unless something is wrong with the circuit. Again the soldering should be checked around the two 6CB6 tube sockets and to the IF and ratio detector transformers. Test the tubes or try exchanging the 6CB6's in their sockets.

LOW SENSITIVITY: Lack of sensitivity might be traced to improper alignment or to a defective tube. Both should be checked if optimum performance is to be obtained. Also, most FM or TV antennas are directional and they should be oriented for best overall signal reception.

INSTALLATION

THE ANTENNA is a very important part of the high fidelity FM installation, especially if good reception of weak signals is desired. There are several different types of antennas, all of which will do a good job if properly installed.

The simplest and certainly the least expensive antenna is a simple folded dipole made of 300 Ω ribbon as indicated in Figure 23. The "T" part of this type of antenna must be hung so that it is as straight as possible, with no twist in the lead. Frequently the lead is stapled, nailed or taped to a piece of wood or heavy cardboard to reinforce it. This type antenna is directional, so it should be oriented for best reception and placed as high as possible. This type is not recommended for long range reception.

Most TV antennas make excellent FM antennas and are frequently used for this purpose. However, it is not advisable to operate the TV set and the tuner off the same line simultaneously, since this will create a mismatch to the detriment of both TV and FM reception. Either a matching device should be used or a switching arrangement worked out.

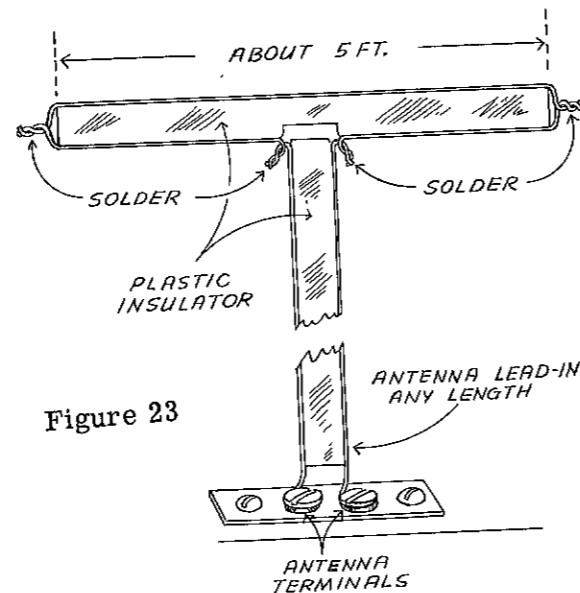

Figure 23

FOLDED DIPOLE ANTENNA
MADE FROM 300 OHM TWIN-
LEAD TRANSMISSION LINE

Best possible operation will be obtained using one of the commercially available antennas designed especially for FM operation and installing it as high off the ground as conveniently possible. The lead-in should be twisted approximately one turn every two feet of length to reduce noise pickup. Conventional TV antenna grounding and lightning protection devices should be used for safe operation.

A 300 Ω antenna input is provided on your Heathkit FM-3A Tuner. Thus the antenna installed must be a 300 Ω impedance type.

PROPER TUNING is essential if full enjoyment of FM programming is to be obtained. Mistuning will result in excessive distortion and noise. When listening to weak stations, only one response will usually be noticed and tuning should be adjusted for maximum quieting, which will coincide with the maximum audio output point. Strong stations will frequently cause a triple tuning response to be evident, a normal characteristic of most FM detectors not using AFC. When tuning a strong station, a weak and distorted response will be noticed, followed by a strong clear response and then another weak one. The strong response should always be used and adjustment made for distortion free performance. Quieting on strong signals will be apparent over a wide tuning range, but distortion on loud passages of music will be noticed if improperly tuned. **TWO OUTPUTS** are provided on the rear panel of the tuner for maximum flexibility of installation. If wired correctly, the output nearest the antenna terminals is the high level output, controlled by the volume control. This output should be used if it is desired to control the audio level at the tuner or if the amplifier used with the tuner has low gain. If the tuner is to be operated through an AM radio or TV set which has a phono jack for this purpose, the high level output should be used.

If the tuner is to be used with a separate preamplifier such as the Heathkit WA-P2 and will be located close to the control unit, it will probably be preferable to use the outer output, which is lower level direct from the detector and de-emphasis network. This output is not affected by the volume control, making it more convenient to operate the controls of the preamplifier, since the output level will always be the same for a given station. This will prevent annoying blasting encountered if the volume control of the tuner is accidentally turned up too far when it is turned on.

The high level variable output may be used with the preamplifier also. For best results, the volume or input level controls on the preamp should be set at low level and the volume control of the tuner used in its mid-range position. Any residual noise that may be present in the 6C4 audio stage will be kept at a minimum in this manner.

A common misunderstanding seems to prevail regarding impedance matching in high fidelity installations. In general, exact matching is required only in the case of power output types of devices, such as a high fidelity power amplifier and its associated speaker system, or a line amplifier to the transmission line and its termination. Most of the other components of the system have medium low or low impedance outputs in the order of 600 Ω to approximately 50 K Ω taken from cathode followers or heavily loaded voltage amplifiers, such as used in the Heathkit FM-3A Tuner. These outputs are usually wired to produce voltage, not power, at low impedance and so matching is not required and in most cases is undesirable. The Heathkit FM-3A, as well as most other audio source equipment, is designed to operate into a load of 100 K Ω or higher. Best performance will be obtained working into an input impedance or resistance of 500 K Ω or 1 megohm.

In general, the Heathkit FM-3A Tuner may be used with any type of transformer operated amplifier which has provision for a crystal phonograph pickup or tuner. Simply connect the audio cable to the appropriate input. If no such input is provided on the unit to be used, most radio servicemen can install one for a reasonable fee.

DO NOT CONNECT THE TUNER TO ANY AC-DC TYPE EQUIPMENT. The entire tuner cabinet and panel is connected to circuit ground and connection to AC-DC equipment will make the tuner hot to one side of the AC line, an extremely dangerous situation. Fatal shock could result. AC-DC amplifiers can be used only when the input is isolated from the AC line.

Sufficient signal exists at the high level output to drive high impedance earphones of the magnetic or crystal type. This makes it possible to listen to favorite late hour programs without disturbing others. Also, binaural broadcasts can be enjoyed by using the FM-3A tuner to drive one earphone and an AM tuner such as the Heathkit BC-1 to drive the other.

HEAT DISSIPATION in the tuner is adequately taken care of through the ventilating slots in the top, back and bottom covers. The rubber feet lift the tuner high enough off the mounting surface to allow air circulation underneath. When installing the tuner, make sure none of the ventilation cutouts are blocked off.

The FM-3A will become quite warm after it has been in operation for a fairly long period of time. This is especially true when the tuner is installed in an abnormally warm location. All components in the tuner are adequately rated to handle this heat without danger of breakdown but there is a chance that the finish on fine wood furniture may be damaged unless certain precautions are observed. In some cases the temperature beneath the tuner may reach as high as 120° F. and it is possible that delicate finishes could be blistered by this heat. If there is reason to doubt the ability of the surface to withstand heat, it may be advisable to put some kind of insulating material between the tuner and the surface. A cloth doily, cardboard or a thin asbestos pad should be sufficient. It is extremely unlikely that the heat would damage glass, leather or plastic surfaces and most finished woods will withstand the heat without damage. Some types of finishes are more delicate than others, however and a little care taken during installation may avoid unhappiness later.

The tuner is primarily designed to sit out in the open and it is for this reason that careful attention has been given to the physical appearance. If the tuner is to be mounted in a cabinet of some type, make sure the back of the enclosure is open and the space large enough to allow unrestricted air circulation. If the available space is small or air circulation is poor, it is recommended that the top and bottom covers be left off to aid cooling. Excessive heating of components in the tuner may lead to premature failure.

Mounting the tuner on end, with the knobs in a vertical plane is not recommended, for radiated heat from the IF amplifier tubes is trapped by the IF transformers, causing overheating.

If it is desired to mount the tuner on its back in a horizontal panel arrangement, it will be necessary to leave the top and bottom covers off to avoid trapping heat on the circuit side of the chassis. Good ventilation in the cabinet is essential if this mode of operation is employed. The panel should be elevated about 1/8" or more above the cabinet panel to allow a circulation path directly around the tuner. This can be accomplished by placing rubber grommets or wood spacers between the two panels.

In all cases where the tuner is operated without the top and bottom covers, some provision should be made so that it will be impossible for small children or pets to get at the back of the tuner. High voltages in the circuit are exposed and they can cause severe injury to anyone coming in contact with them.

REPLACEMENTS

Material supplied with Heathkits has been carefully selected to meet design requirements and ordinarily will fulfill its function without difficulty. Occasionally improper instrument operation can be traced to a faulty tube or component. Should inspection reveal the necessity for replacement, write to the Heath Company and supply all of the following information:

- A. Thoroughly identify the part in question by using the part number and description found in the manual parts list.
- B. Identify the type and model number of kit in which it is used.
- C. Mention the order number and date of purchase.
- D. Describe the nature of defect or reason for requesting replacement.

The Heath Company will promptly supply the necessary replacement. Please do not return the original component until specifically requested to do so. Do not dismantle the component in question as this will void the guarantee. If tubes are to be returned, pack them carefully to prevent breakage in shipment as broken tubes are not eligible for replacement. This replacement policy does not cover the free replacement of parts that may have been broken or damaged through carelessness on the part of the kit builder.

SERVICE

In event continued operational difficulties of the completed instrument are experienced, the facilities of the Heath Company Service Department are at your disposal. Your instrument may be returned for inspection and repair for a service charge of \$5.00 plus the cost of any additional material that may be required. **THIS SERVICE POLICY APPLIES ONLY TO COMPLETED INSTRUMENTS CONSTRUCTED IN ACCORDANCE WITH THE INSTRUCTIONS AS STATED IN THE MANUAL.** Instruments that are not entirely completed or instruments that are modified in design will not be accepted for repair. Instruments showing evidence of acid core solder or paste fluxes will be returned not repaired.

The Heath Company is willing to offer its full cooperation to assist you in obtaining the specified performance level in your instrument. Factory repair service is available for a period of one year from the date of purchase or you may contact the Engineering Consultation Department by mail. For information regarding possible modification of existing kits, it is suggested that you refer to any one or more of the many publications that are available on all phases of electronics. They can be obtained at or through your local library, as well as at any electronic outlet store. Although the Heath Company sincerely welcomes all comments and suggestions, it would be impossible to design, test, evaluate and assume responsibility for proposed circuit changes for specific purposes. Therefore, such modifications must be made at the discretion of the kit builder according to information which will be much more readily available from some local source.

SHIPPING INSTRUCTIONS

Before returning a unit for service, be sure that all parts are securely mounted. Attach a tag to the instrument giving name, address and trouble experienced. Pack in a rugged container, preferably wood, using at least three inches of shredded newspaper or excelsior on all sides. **DO NOT SHIP IN THE ORIGINAL KIT CARTON AS THIS CARTON IS NOT CONSIDERED ADEQUATE FOR SAFE SHIPMENT OF THE COMPLETED INSTRUMENT.** Ship by prepaid express if possible. Return shipment will be made by express collect. Note that a carrier cannot be held liable for damage in transit if packing, in HIS OPINION, is insufficient.

SPECIFICATIONS

All prices are subject to change without notice. The Heath Company reserves the right to discontinue instruments and to change specifications at any time without incurring any obligation to incorporate new features in instruments previously sold.

WARRANTY

The Heath Company limits its warranty of parts supplied with any kit to a period of three (3) months from the date of purchase. Replacement will be made only when said part is returned postpaid, with prior permission and in the judgment of the Heath Company was defective at the time of sale. This warranty does not extend to any Heathkits which have been subjected to misuse, neglect, accident and improper installation or applications. Material supplied with a kit shall not be considered as defective, even though not in exact accordance with specifications, if it substantially fulfills performance requirements. This warranty is not transferable and applies only to the original purchaser. This warranty is in lieu of all other warranties and the Heath Company neither assumes nor authorizes any other person to assume for them any other liability in connection with the sale of Heathkits.

The assembler is urged to follow the instructions exactly as provided. The Heath Company assumes no responsibility or liability for any damages or injuries sustained in the assembly of the device or in the operation of the completed instrument.

HEATH COMPANY
Benton Harbor, Michigan

PART No.	PARTS Per Kit	DESCRIPTION	PART No.	PARTS Per Kit	DESCRIPTION
Resistors					
✓ 1-1	1	47 Ω	Wire-Cable-Sleeving		
✓ 1-2	3	68 Ω	✓ 89-1	1	Line cord
✓ 1-9	2	1 KΩ	✓ 340-2	1	length Bare wire
✓ 1-11	1	1.5 KΩ	✓ 343-2	1	length Shielded cable
✓ 1-19	2	6.8 KΩ	✓ 344-1	1	length Hookup wire
✓ 1-20	2	10 KΩ	✓ 346-1	1	length Sleeving
✓ 1-22	1	22 KΩ	✓ 346-6	2	length 3/8" sleeving
✓ 1-25	1	47 KΩ	Tubes-Pilot Lamp		
✓ 1-26	2	100 KΩ	✓ 411-4	1	6C4
✓ 1-31	1	330 KΩ	✓ 411-40	1	6AL5
✓ 1-33	1	470 KΩ	✓ 411-64	1	6X4
✓ 1-35	2	1 megohm	✓ 411-67	2	6CB6
✓ 1-44	2	2.2 KΩ	✓ 411-71	1	6BQ7A
✓ 1-60	3	68 KΩ	✓ 411-80	1	6U8
✓ 1-66	1	150 Ω	✓ 412-1	2	#47 bulb
✓ 1-4A	1	8.2 KΩ 1 watt	Grommets-Clips-Tool-Nameplate-Feet		
✓ 1-17A	1	100 Ω 1 watt	✓ 73-1	4	3/8" rubber grommet
✓ 1-25A	1	6.8 KΩ 1 watt	✓ 73-4	2	5/16" rubber grommet
✓ 1-15B	1	1 KΩ 2 watt	✓ 73-6	4	7/16" rubber grommet
Condensers					
✓ 21-14	4	.001 μfd disc	✓ 260-7	3	IF transformer mounting clip
✓ 21-16	2	.01 μfd disc	✓ 261-4	4	Rubber feet
✓ 21-17	3	270 μμf disc	✓ 391-1	1	Nameplate
✓ 21-27	8	.005 μfd disc	✓ 490-1	1	Alignment tool
✓ 21-32	2	47 μμf disc	Metal Parts		
✓ 21-43	1	.001 μfd 1000 volt disc	✓ 90-M37F	1	Cabinet Shell
✓ 23-61	2	.05 μfd tubular	✓ 200-M109	1	Chassis
✓ 25-4	1	10 μfd 25 volt	✓ 100-M96	1	Front panel
✓ 25-19	1	20 μfd 150 volt	✓ 203-M77F	1	Rear panel
✓ 25-30	1	20-20 μfd 350 volt	✓ 204-M90	1	Left end bracket
Coils-Chokes-Transformers					
✓ 40-65	1	Neutralizing coil	✓ 204-M91	1	Right end bracket
✓ 40-66	1	Antenna coil	✓ 205-M47F	1	Bottom plate
✓ 45-1	1	RF choke	✓ 207-M15	1	Panel clamp
✓ 52-6	2	IF transformer	Hardware		
✓ 53-2	1	Ratio det. transformer	250-2	14	3-48 x 5/16" screw
✓ 54-34	1	Power transformer	250-7	3	6-32 x 3/16" screw
✓ 100-89	1	Tuning assembly	250-8	4	#6 x 3/8 sheet metal screw
Control-Dial Parts-Knobs					
✓ 19-27	1	1 megohm control w/switch	250-9	14	6-32 x 3/8" screw
✓ 100-M70	1	Tuning drum	250-16	1	8-32 x 3/16" set screw
✓ 100-M85	1	Dial cord assembly	250-18	2	8-32 x 3/8" screw
✓ 100-M90F	1	Dial plate assembly	250-46	18	6-32 self-tapping screw
✓ 253-28	3	Plastic "O" washer	252-1	14	3-48 hex nut
✓ 258-1	1	Dial cord spring	252-3	15	6-32 hex nut
✓ 453-19	1	Drive shaft	252-4	2	8-32 hex nut
✓ 455-13	1	Shaft bushing	252-7	2	3/8-32 control nut
✓ 462-28	2	Knob	252-16	2	Speed nut
✓ 463-11	1	Dial pointer	253-10	1	3/8 nickel washer
Sockets-Plugs-Terminal Strips					
✓ 431-3	1	3-lug terminal strip	253-21	5	9/16 flat washer
✓ 431-6	1	2-lug screw-type strip	254-1	18	#6 lockwasher
✓ 431-10	4	3-lug terminal strip	254-2	2	#8 lockwasher
✓ 431-12	1	4-lug terminal strip	254-4	2	3/8 control lockwasher
✓ 431-14	2	2-lug terminal strip	254-7	21	#3 lockwasher
✓ 434-44	2	Pilot lamp socket	255-2	4	#6 x 3/16 spacer
✓ 434-37	5	7-pin socket	259-1	1	#6 solder lug
✓ 434-42	2	Phono connector socket	259-6	7	#3 solder lug
✓ 434-56	2	9-pin socket	✓ 595-142	1	Construction manual
✓ 438-4	2	Phono plug			

GROMMETS

SPACER



LOCKWASHERS



SOLDER LUGS

WASHERS



NUTS



SCREWS



SCREWS

SPEED NUT



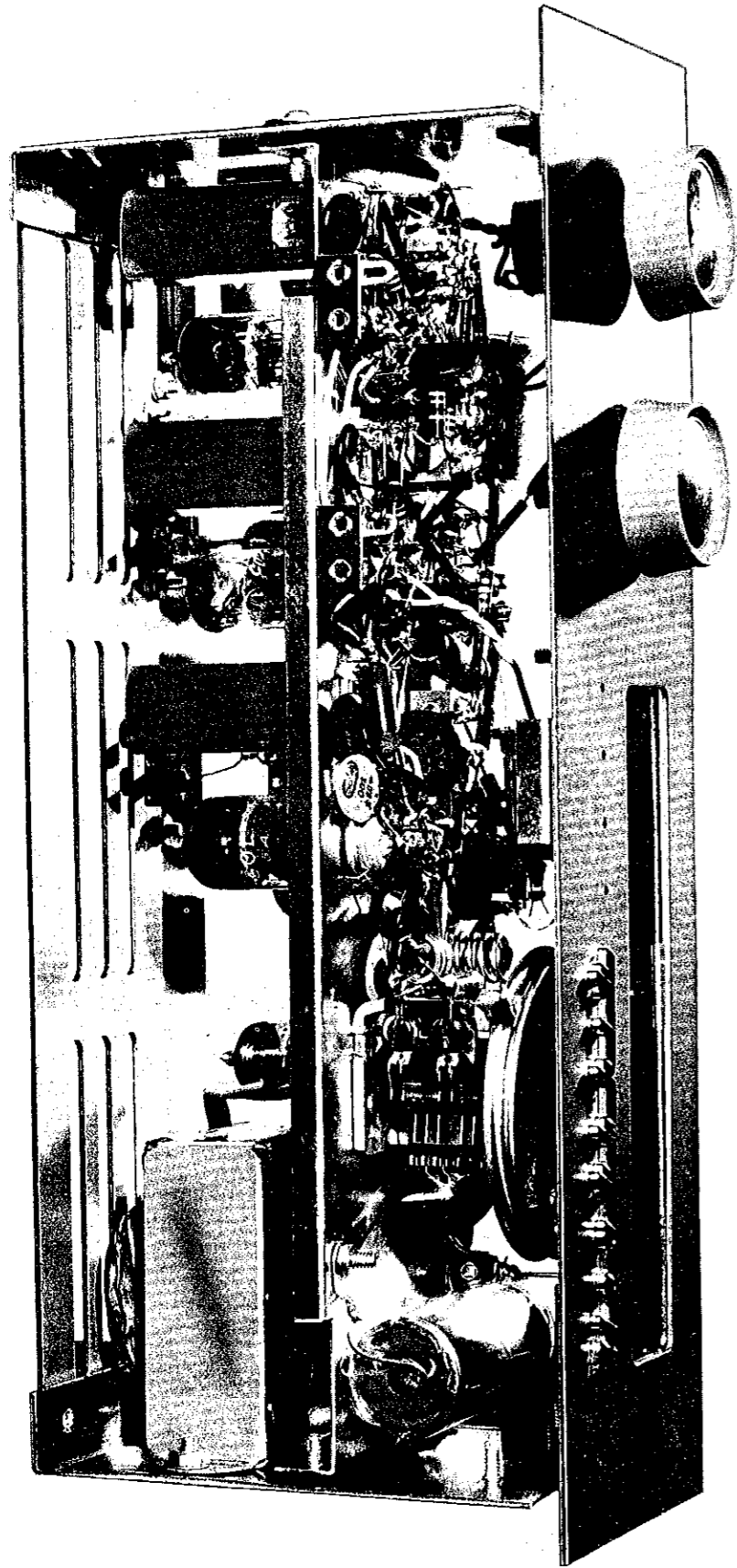

INSIDE VIEW CHASSIS BOTTOM

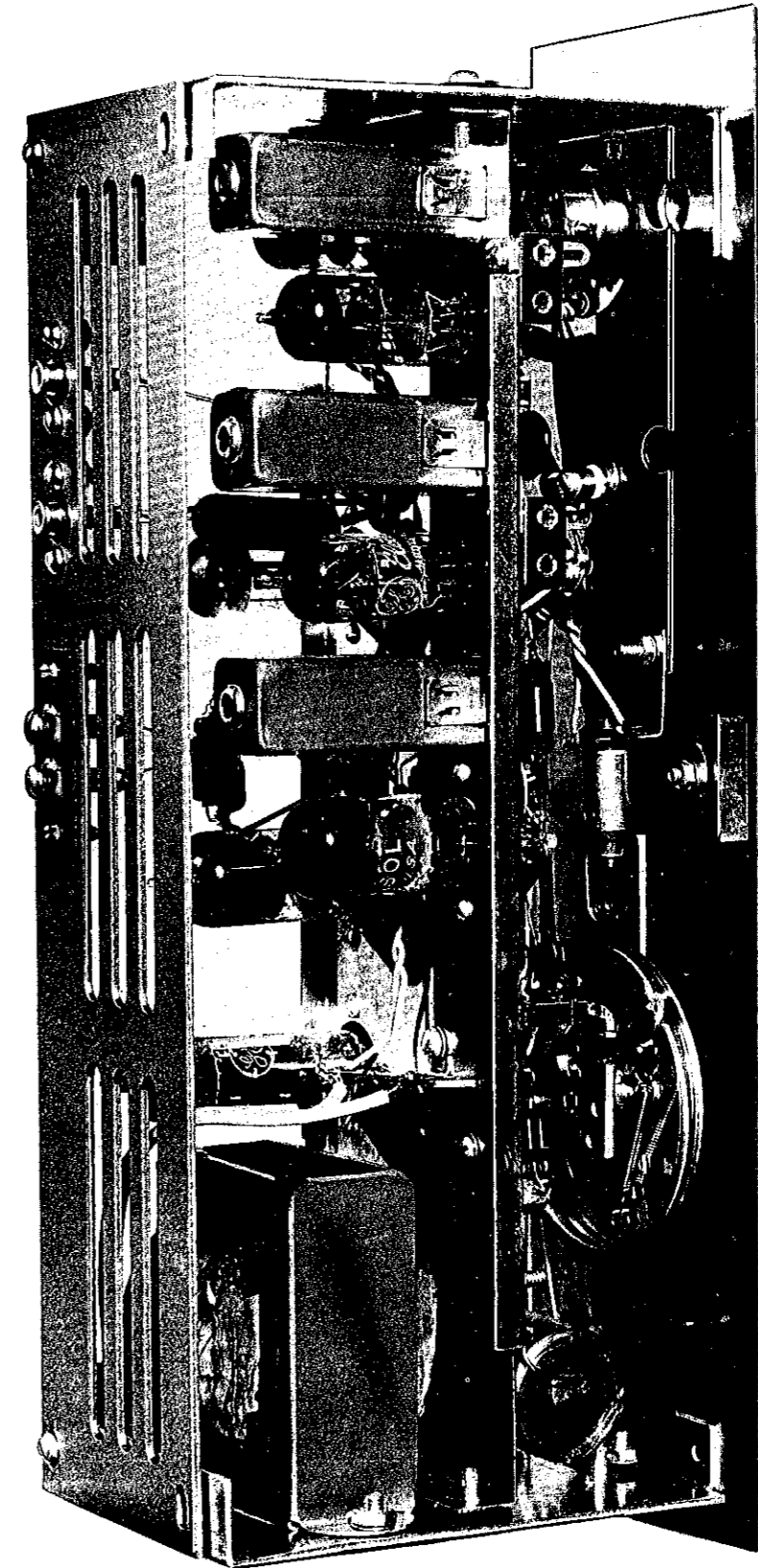

INSIDE VIEW CHASSIS TOP

HELPFUL KIT BUILDING INFORMATION

Before attempting actual kit construction read the construction manual through thoroughly to familiarize yourself with the general procedure. Note the relative location of pictorials and pictorial inserts in respect to the progress of the assembly procedure outlined.

This information is offered primarily for the convenience of novice kit builders and will be of definite assistance to those lacking thorough knowledge of good construction practices. Even the advanced electronics enthusiast may benefit by a brief review of this material before proceeding with kit construction. In the majority of cases, failure to observe basic instruction fundamentals is responsible for inability to obtain desired level of performance.

RECOMMENDED TOOLS

The successful construction of Heathkits does not require the use of specialized equipment and only basic tools are required. A good quality electric soldering iron is essential. The preferred size would be a 100 watt iron with a small tip. The use of long nose pliers and diagonal or side cutting pliers is recommended. A small screw driver will prove adequate and several additional assorted screw drivers will be helpful. Be sure to obtain a good supply of rosin core type radio solder. Never use separate fluxes, paste or acid solder in electronic work.

ASSEMBLY

In the actual mechanical assembly of components to the chassis and panel, it is important that the procedure shown in the manual be carefully followed. Make sure that tube sockets are properly mounted in respect to way or pin numbering location. The same applies to transformer mountings so that the correct transformer color coded wires will be available at the proper chassis opening.

Make it a standard practice to use lock washers under all 6-32 and 8-32 nuts. The only exception being in the use of solder lugs—the necessary locking feature is already incorporated in the design of the solder lugs. A control lock washer should always be used between the control and the chassis to prevent undesirable rotation in the panel. To improve instrument appearance and to prevent possible panel marring use a control flat nickel washer under each control nut.

When installing binding posts that require the use of fiber insulating washers, it is good practice to slip the shoulder washer over the binding post mounting stud before installing the mounting stud in the panel hole provided. Next, install a flat fiber washer and a solder lug under the mounting nut. Be sure that the shoulder washer is properly centered in the panel to prevent possible shorting of the binding post.

WIRING

When following wiring procedure make the leads as short and direct as possible. In filament wiring requiring the use of a twisted pair of wires allow sufficient slack in the wiring that will permit the twisted pair to be pushed against the chassis as closely as possible thereby affording relative isolation from adjacent parts and wiring.

When removing insulation from the end of hookup wire, it is seldom necessary to expose more than a quarter inch of the wire. Excessive insulation removal may cause a short circuit condition in respect to nearby wiring or terminals. In some instances, transformer leads of solid copper will have a brown baked enamel coating. After the transformer leads have been trimmed to a suitable length, it is necessary to scrape the enamel coating in order to expose the bright copper wire before making a terminal or soldered connection.

In mounting parts such as resistors or condensers, trim off all excess lead lengths so that the parts may be installed in a direct point-to-point manner. When necessary use spaghetti or insulated sleeving over exposed wires that might short to nearby wiring.

It is urgently recommended that the wiring dress and parts layout as shown in the construction manual be faithfully followed. In every instance, the desirability of this arrangement was carefully determined through the construction of a series of laboratory models.

SOLDERING

Much of the performance of the kit instrument, particularly in respect to accuracy and stability, depends upon the degree of workmanship used in making soldered connections. Proper soldered connections are not at all difficult to make but it would be advisable to observe a few precautions. First of all before a connection is to be soldered, the connection itself should be clean and mechanically strong. Do not depend on solder alone to hold a connection together. The tip of the soldering iron should be bright, clean and free of excess solder. Use enough heat to thoroughly flow the solder smoothly into the joint. Avoid excessive use of solder and do not allow a flux flooding condition to occur which could conceivably cause a leakage path between adjacent terminals on switch assemblies and tube sockets. This is particularly important in instruments such as the VTVM, oscilloscope and generator kits. Excessive heat will also burn or damage the insulating material used in the manufacture of switch assemblies. Be sure to use only good quality rosin core radio type solder.

Antenna General		Resistor General		Neon Bulb		Receptacle two-conductor	
Loop		Resistor Tapped		Illuminating Lamp		Battery	
Ground		Resistor Variable		Switch Single pole Single throw		Fuse	
Inductor General		Potentiometer		Switch double pole single throw		Piezoelectric Crystal	
Air core Transformer General		Thermistor		Switch Triple pole Double throw		1000 =	K
Adjustable Powdered Iron Core		Jack two conductor		Switch Multipoint or Rotary		1,000,000 =	M
Magnetic Core Variable Coupling		Jack three conductor		Speaker		OHM =	Ω
Iron Core Transformer		Wires connected		Rectifier		Microfarad =	MF
Capacitor General		Wires Crossing but not connected		Microphone		Micro Microfarad =	MMF
Capacitor Electrolytic		A. Ammeter V. Voltmeter		Typical tube symbol 	Binding post Terminal strip		Wiring between like letters is understood
Capacitor Variable		G. Galvanometer MA. Milliammeter uA. Microammeter, etc.					

HEATH COMPANY

A Subsidiary of Daystrom Inc.

THE WORLD'S FINEST ELECTRONIC EQUIPMENT IN KIT FORM

BENTON HARBOR, MICHIGAN

Peerless ELECTRICAL PRODUCTS

division of ALTEC LANSING CORPORATION
9356 SANTA MONICA BLVD., BEVERLY HILLS, CALIF.

BRADSHAW 2-6254
CRESTVIEW 3-5101

Spec. 16309

Customer: Heath Company

OUTPUT TRANSFORMER

Max. operating level 25 watts + 44 DBM
Freq. response ± 1 DB 10 CPS to 75 KC

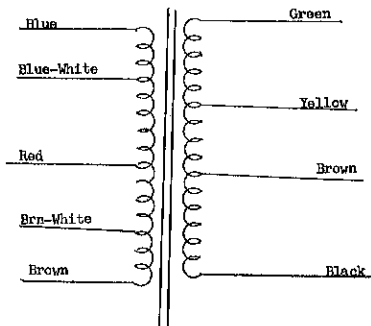

TEST VOLTAGE

Pri 2000 V. RMS
Sec 1250 V. RMS

FRI Z
10,000 \sim C.T.
With Screen
Taps

CONNECT TO
Blue-Red-Brown
Blue-Wh & Brn-Wh

MOUNT WITH 8-32 SCREWS

SEC Z
16 \sim
8 \sim
4 \sim

CONNECT TO
Grn & Blk
Yel & Blk
Brn & Blk

1-10-55
(cs)



SPECIAL NOTICE MODEL W-5M KIT

ed below, should be made in your W-5M manual before you

- om: () Connect a 15 k ohm 1 watt resistor
(medium body.....)
- to: () Connect a 15k ohm 2 watt resistor
(large body.....)