

ASSEMBLY AND OPERATION OF THE HEATHKIT "CHIPPEWA" LINEAR AMPLIFIER MODEL KL-1

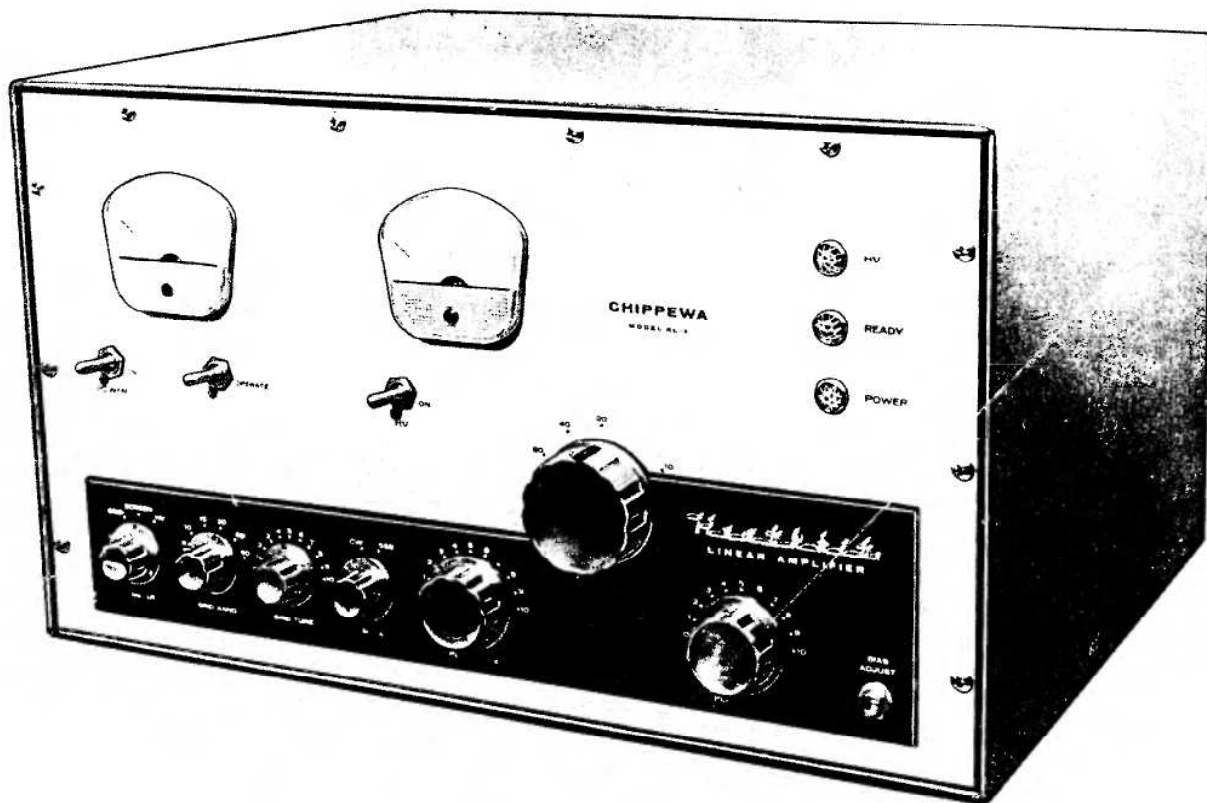

SPECIFICATIONS

Driving Power Required (measured at input connector on 10 meters):

Class AB1 (tuned grid) ¹ :	10 watts peak.
Class C (tuned grid) ¹ :	40 watts peak.
Class AB1 (swamped grid) ² :	60 watts peak.

Power Input:

Class AB1 (SSB-voice modulation):	2000 watts PEP.
Class AB1 (SSB-two tone test):	1300 watts.
Class AB1 (AM linear):	1000 watts.
Class C (CW):	1000 watts.

Notes: 1 - Less on lower frequencies
2 - Same on all frequencies

Power Output (20 meters)³:

Class AB1 (SSB-voice modulation): 900 watts PEP.
Class AB1 (SSB-two tone test)⁴: 550 watts.
Class AB1 (AM linear): 300 watts.
Class C (CW): 750 watts.

Output Impedance: 50-72 ohms (unbalanced).

Input Impedance: Tuned grid: 50-72 ohms (unbalanced).
Swamped grid: 170 ohms (unbalanced).

Band Coverage: 80, 40, 20, 15, 10 meters.

Panel metering: 0-50 ma grid current.
0-100 ma screen current.
0-5000 volt plate voltage.
0-1000 ma plate current.

Tube Complement:

Final Tubes: 2 - 4-400A.
Clamp Tube: 1 - 6DQ6.
Voltage Regulators: 4 - OD3.
2 - OC3.

Power Requirements:

AC (Power Supply Primary Circuit): . . . 250 watts, 115 volts, 50-60 cycles.
DC: 3000 volts, 450 ma.

Cabinet Size: 19 1/2" wide x 11 5/8" high x 16" deep.

Net Weight: 61 lbs.

Shipping Weight: 70 lbs.

Notes: 3 - At specified inputs
4 - Third and fifth order distortion products down in excess of 30 db.

INTRODUCTION

With the increasing popularity of single sideband suppressed carrier phone transmission as a mode of amateur communication, more amateurs are finding it possible to run higher transmitter power inputs than they could previously afford with conventional AM equipment. Since high level modulating equipment is not necessary in single sideband service, the cost of converting to high power is considerably reduced.

In keeping with this trend toward higher power in single sideband service, the Heathkit "Chippewa" Model KL-1 Linear Amplifier was designed to provide capabilities for operating at maximum legal amateur power inputs in SSB, CW or AM service, using one of the many popular SSB, CW and AM exciters available today as a driver.

Attractively styled to complement the Heathkit "Apache" Transmitter, "Mohawk" Receiver and SB-10 Single Sideband Adapter, the "Chippewa" Linear Amplifier adds to this group of ham equipment full power capability along with complete versatility in the present day modern amateur station.

Π network output coupling is employed to provide easy matching to low impedance antennas and to reduce harmonic radiation. The push-pull tuned grid input circuit requires a minimum of driving power and provides stable operation through grid neutralization. Carefully designed corks, critically placed, eliminate all traces of parasitic oscillation.

Convenient panel controls include POWER switch, TUNE-OPERATE switch, HV (high voltage) ON-OFF switch, FINAL BAND switch, METER switch, GRID BAND switch, GRID TUNING and MODE switches, PLATE TUNING, PLATE LOADING and BIAS ADJUST.

The GRID BAND switch, in addition to providing a tuned input circuit on all bands, also provides an untuned grid circuit position. In this switch position the grid circuit utilizes a high wattage, low resistance swamping resistor. If, therefore, the exciter to be used has a peak power output capability of approximately 65 watts or more, grid circuit tuning can thus be eliminated.

The METER switch enables the operator to read grid current, screen current and plate voltage. A separate second panel meter is provided to monitor plate current continuously.

The MODE switch permits instant selection of either CW, SSB, or AM operation. In the CW position the amplifier operates Class C, making use of the higher efficiency of this class of operation. In SSB position the amplifier operates Class AB1 for linear SSB and AM operation with "voltage only" drive required.

Accessory connections are available on the rear apron of the chassis providing complete compatibility with all control circuitry in the Heathkit "Apache" Transmitter and SB-10 SSB Adapter combination. These accessory connections will be found versatile enough to accomplish control of the KL-1 by many existing popular exciters. Connections to the power supply to be used are also located on the rear apron. The control circuitry, while designed to be used with the Heathkit Kilowatt Power Supply, Model KS-1, is conventional and thoroughly adaptable for use with other existing power supplies.

RF input and output coaxial connections, as well as a special high voltage coaxial connector, are also located on the rear apron in addition to a permanently installed coaxial connection to an RF pickup coil which samples RF voltage in the plate tank circuit. This latter connection provides a convenient and efficient means of continuously monitoring the RF output waveform, utilizing an accessory oscilloscope.

The formed and welded one piece cabinet, as well as the filtered exciter control leads and shielded power supply cable, all contribute to effectively reduce radiations which cause TVI.

IN AN RF AMPLIFIER OF THIS SIZE WITH ITS ASSOCIATED POWER SUPPLY, LETHAL VOLTAGES ARE PRESENT. AS A CONSEQUENCE, GREAT CARE MUST BE EXERCISED AT ALL TIMES WHEN TESTING OR OPERATING THIS EQUIPMENT. Adequate ground connections must be provided for each chassis.

The following block diagram and circuit description will provide the kit builder with a sound understanding of the amplifier, which will prove an invaluable aid during construction. We recommend that you read the Circuit Description thoroughly before beginning construction.

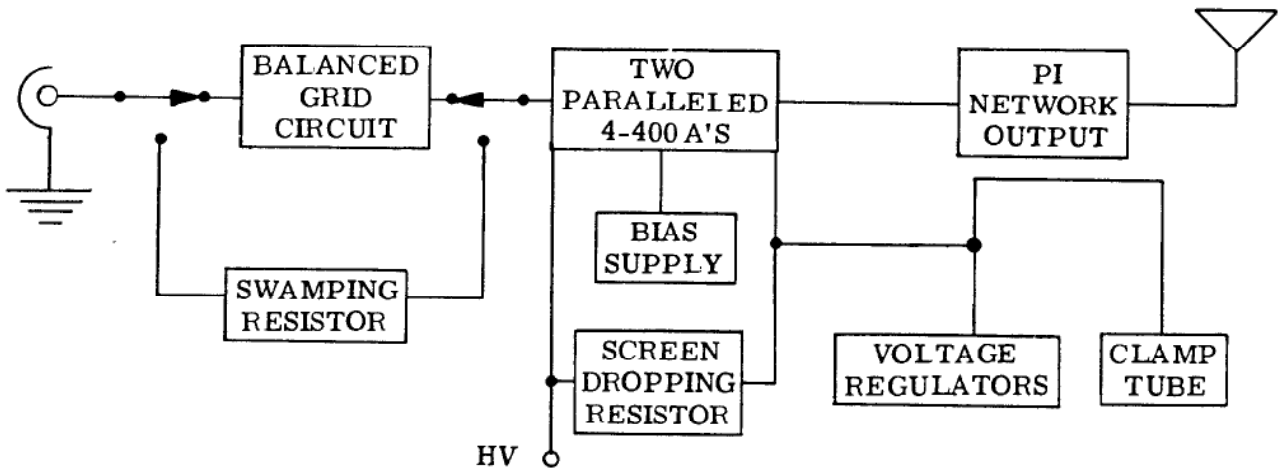

BLOCK DIAGRAM

CIRCUIT DESCRIPTION

GRID CIRCUIT

Two grid circuit configurations are used in the KL-1 in order to provide the versatility necessary to accommodate the variety of power output levels available in current SSB excitors in use.

One configuration consists of a push-pull tuned circuit capable of being switched to 80, 40, 20, 15 or 10 meters. Input excitation is link-coupled to the center of this balanced grid tank coil and the circuit is tuned with a dual 50 $\mu\mu\text{f}$ butterfly capacitor. The use of a push-pull tuned grid circuit allows the use of low power excitors to drive the KL-1 and also provides for grid neutralization of the amplifier; a method that is simple, economical and dependable. The RF voltage fed back to the grid from the amplifier through the grid-plate capacity of the 4-400A's is cancelled out by an equal voltage opposite in phase to that which is supplied to the grid by allowing the end of the grid tank coil opposite the grid connection to "look" at the 4-400A plates through a small neutralizing stub.

When the "R" position of the GRID BAND switch is selected, the entire tuned circuit is bypassed and the second or resistive grid circuit configuration is employed. The input excitation is delivered to a 170 Ω , 80 watt, non-inductive load resistor. The voltage developed across this resistive load provides the required driving voltage for Class AB1 operation. This grid circuit configuration can be used only for Class AB1 linear operation but has the advantage of being capable of using higher power excitors as drivers without the necessity of power reducing networks. No neutralization or grid tuning is required on any band in Class AB1 linear operation because of the very heavy grid loading provided by the swamping resistor.

Regardless of which grid driving method is used, excitation is fed in parallel to the grids of both amplifier tubes through a blocking capacitor and parasitic choke. Fixed DC grid bias voltage is shunt fed to the grid through an RF choke. This bias voltage is adjustable and is set with a front panel mounted rheostat to fix the appropriate value of resting plate current for Class AB1 operation. An additional adjustable grid leak resistor (shorted out when operating Class AB1) furnishes added bias voltage for proper Class C operation.

A meter shunt in series with the grid bias lead allows panel metering of the grid current over a range from 0 to 50 milliamperes.

SCREEN CIRCUIT

The screen voltage for the 4-400A's is obtained through series dropping resistors and voltage regulator tubes operating from the high voltage plate supply. In addition, a clamp tube, left connected to the screens along with the VR tubes at all times provides complete cutoff of the final tube during CW key-up conditions. This is important in order to prevent any final tube noise from appearing in the receiver when operating full break-in CW.

In Class AB1 operation, the MODE switch contacts shorting out a portion of the fourth dropping resistor for CW operation, shown on the Schematic, are opened and the fourth resistor tap is adjusted to the proper value of voltage regulator current. The screen voltage is then well regulated at 810 volts over the entire range of screen current. The cathode and screen of the clamp tube are at ground potential during Class AB1 operation, thus the clamp tube is completely cut off and does not interfere with the action of the VR tubes.

In Class C operation, the MODE switch shorts out the fourth dropping resistor and the three 14 K Ω resistors, in series, provide the proper voltage drop to establish a Class C key-down operating screen voltage of approximately 300 volts. This is well below the firing voltage of the VR tubes and thus the VR tubes do not interfere with normal Class C operation. However, should the clamp tube fail, the VR tubes will fire and hold the screen voltage to a safe value during key-up conditions, thus affording extra protection for the final tubes.

The clamp tube circuit is unusual in that, during Class C CW operation, the clamp tube cathode is placed at the negative fixed bias potential and the clamp tube screen is at ground, or zero, potential. The sharp cutoff pentode operation thus obtained enables the negative voltage developed by the final tube grid current flow through the final grid leak resistor when drive is applied during key-down conditions to cut the clamp tube off. The 4-400A screens thus operate at their normal Class C voltage. However, when drive is removed during key-up condition, the clamp tube grid and cathode are at equal potential, and the clamp tube draws sufficient current through the screen dropping resistors to actually lower the 4-400A screen voltage to a negative potential with respect to ground. The negative screen voltage, along with the fixed negative grid bias completely cuts off the final tubes. The plate to cathode voltage in the clamp tube is low enough under these conditions so that, even though heavy clamp tube plate current is drawn, the clamp tube plate dissipation is well under the maximum rating. The series resistance in both the grid and screen leads of the clamp tube serve to limit grid and screen dissipation to safe values.

For tuning up in Class C operation, the TUNE position of the TUNE-OPERATE switch places the screens at a point on a voltage divider network where the voltage is approximately 150 volts. This limits the off resonance plate current of the 4-400A's to a safe value to prevent damage due to excessive plate dissipation. Once the amplifier plate circuit has been resonated, returning the switch to the OPERATE position allows normal tuning and operation.

The screens are well bypassed for maximum stability and parasitic chokes help eliminate all traces of parasitic oscillations in both the final and clamp tubes.

BIAS AND CONTROL CIRCUITS

A fixed bias supply is incorporated, using a full-wave bridge rectifier and choke input filter circuit. Two adjustments are made in setting bias voltages: One for Class AB1 operation made from the front panel; another for Class C operation in the form of an adjustable resistor accessible at a subchassis location. Once set, excluding tube aging and fine adjustment for maximum linearity, bias adjustments should remain constant.

The control relay circuitry associated with the accessory socket basically requires that 115 V AC be applied to the control relay from the exciter when either the VOX relay is energized in SSB or linear AM operation, or grid drive is applied to the KL-1 in CW operation. This voltage is easily obtained from the antenna relay terminals of the exciter. The antenna relay itself can be connected in parallel with the control relay by means of the accessory socket terminals of the KL-1. If the antenna relay voltage is obtained from different points in the exciter for SSB or linear AM and CW operation (as in the case of the Heathkit Model TX-1 and SB-10 combination), then a set of mode switch contacts selects the proper voltage, as shown.

The function of the control relay is twofold. In SSB or linear AM operation, during standby periods one set of control relay contacts lifts the ground end of the bias adjust rheostat in order to apply cutoff bias to the KL-1. This avoids excessive power supply plate relay switching, which would shorten relay life as well as be objectionably noisy. During CW operation, the MODE switch contacts, in parallel with the remaining control relay contacts, are open, requiring that the control relay be closed before the high voltage can be applied. Since in CW operation the relay is energized by the application of grid drive to the KL-1 from the exciter, this feature permits single switch control at the exciter (leaving the KL-1 HV switch in the ON position). It also provides extra protection for the KL-1, in conjunction with the clamp tube, against tube damage due to the application of plate voltage without grid drive.

A meter shunt in series with the screen lead allows panel metering of the screen current over a range from 0 to 100 milliamperes.

PLATE CIRCUIT

The plate circuit of the KL-1 utilizes a conventional pi network for maximum harmonic suppression and ease of tuning. The plates of the 4-400A's are shunt fed, utilizing an appropriate RF choke, blocking capacitor, bypass capacitor and ruggedly designed parasitic chokes. An RF choke is placed across the output of the pi network to protect against high voltage being placed on the antenna in the event of blocking capacitor failure.

A specially designed dual section tuning capacitor provides a separate low capacity section for tuning the 10 and 15-meter bands in order to maintain an adequate L/C ratio. A special switch coupled to the PLATE BAND switch connects both sections of the tuning capacitor together for tuning the 20, 40 and 80-meter bands.

The plate current of the KL-1 is continuously monitored by a separate meter in series with the plate lead. This meter reads 1000 milliamperes full scale and is specially designed to safely withstand the high plate voltages involved.

A 5 megohm series meter shunt allows panel metering of the plate voltage from 0 to 5000 volts DC.

PRELIMINARY TESTING

CAUTION: In any of the following steps on testing, operation and installation, as well as in troubleshooting cases of difficulty, PLEASE REMEMBER THAT LETHAL VOLTAGES AND CURRENTS PRESENT WITHIN THIS AMPLIFIER CAN CAUSE INSTANT DEATH. The following shaded steps indicate prevailing dangerous conditions.

Help us to help you STAY ALIVE by following these steps:

1. Read all instructions carefully BEFORE you test check.
2. Use EVERY PRECAUTION when working on the equipment to AVOID electrical shock by- -
 - a. Turning OFF and DISCONNECTING the amplifier from its source of power if at all possible.
 - b. If it should be necessary to make tests called for with power ON, use EXTREME CARE. If possible, disconnect power, insert instruments, then keeping yourself clear of the leads, reapply power and make the desired measurements. Then, remove power and disconnect instruments involved in the test.
 - c. If this cannot be accomplished and you must contact the measured circuits with power ON, use insulated tools, prods or probes and, IN ALL CASES, work with one hand behind your back to avoid completing an accidental LETHAL electrical path with your body.
 - d. USE COMMON SENSE - WHY TAKE CHANCES? - IT'S YOUR LIFE - PLEASE BE CAREFUL!!

In the following tests frequent reference is made to the EXCITER and its controls. For those who are driving the KL-1 Linear Amplifier with a self-contained single sideband exciter these references to the exciter include controls which will all be located in such a self-contained unit.

For those who use an RF exciter (such as the DX-100 or "Apache" TX-1 with an adapter such as the SB-10 Sideband Adapter) the word EXCITER comprises both the RF unit and the Adapter with their associated controls.

Before connecting any cables to the KL-1 or performing any tests, it will be helpful in avoiding trouble from the very beginning to make a few ohmmeter continuity checks. If the readings obtained are within $\pm 10\%$ of those given using a Heathkit Volt-Ohm-Milliammeter Model MM-1, or equivalent, it may be safely considered that your amplifier is correctly wired and the following tests and adjustments entered into with confidence. If readings do not check, see section IN CASE OF DIFFICULTY on Page 81.

PRE-TEST OHMMETER CHECKS

NOTE: In the following checks "zero resistance" indicates a continuous or short circuit path. "Infinite resistance" indicates no continuity or an "open" circuit.

A. RF input receptacle resistance to ground -

() GRID BAND switch in 80, 40, 20, 15 or 10-meter position - zero resistance.

() GRID BAND switch in "R" position - 180Ω .

B. HV input receptacle to ground -

() TUNE-OPERATE switch in OPERATE position - 5 megohm.

() TUNE-OPERATE switch in TUNE position - $65 K\Omega$.

C. Accessory socket BF -

() Infinite resistance to ground on all pins under all control positions.

() Pin 7 to 8 - $2.6 K\Omega$ in all switch positions.

() Pin 2 to 4 - $2.6 K\Omega$ with MODE switch in CW position.

() Pin 2 to 4 - infinite resistance with MODE switch in SSB position.

() Pin 3 to 6 - zero ohms in any switch position.

D. Control plug BD -

() Pin 1 to ground - infinite resistance.

() Pin 2 to ground - infinite resistance.

() Pin 3 to ground - infinite resistance.

() Pin 4 to ground - infinite resistance.

() Pin 5 to ground - infinite resistance.

() Pin 6 to ground - zero resistance.

() Pin 1 to 2 - zero resistance with POWER switch in ON position.

() Pin 1 to 2 - infinite resistance with POWER switch in OFF position.

() Pin 1 to 3 - zero resistance with POWER switch in ON position.

() Pin 1 to 3 - infinite resistance with POWER switch in OFF position.

- () Pin 2 to 3 - zero resistance in all switch positions.
- () Pin 1 to 4 - 1100 Ω resistance with POWER switch in ON position.
- () Pin 1 to 4 - infinite resistance with POWER switch in OFF position.
- () Pin 1 to 4 - 1.0 Ω resistance with POWER and HV switches in ON position and MODE switch in SSB position.
- () Pin 1 to 4 - 1100 Ω resistance with POWER and HV switches in ON position and MODE switch in CW position.
- () Pin 2 to 4 - 1100 Ω resistance with the MODE switch in CW position.
- () Pin 2 to 4 - 1.0 Ω resistance with MODE switch in SSB position.
- () Pin 3 to 4 - 1100 Ω resistance with HV switch in OFF position.
- () Pin 3 to 4 - zero resistance with HV switch in ON position and MODE switch in SSB position.
- () Pin 3 to 4 - 1100 Ω resistance with HV switch in ON position and MODE switch in CW position.
- () Pin 1 to 5 - infinite resistance with POWER switch in OFF position.
- () Pin 1 to 5 - 500 Ω resistance with POWER switch in ON position, HV switch OFF.
- () Pin 1 to 5 - 250 Ω resistance with POWER switch in ON position, HV switch in ON position, MODE switch in SSB position.
- () Pin 2 to 5 - 500 Ω resistance with HV switch in ON position, MODE switch in CW position.
- () Pin 2 to 5 - 250 Ω resistance with HV switch in ON position, MODE switch in SSB position.
- () Pin 2 to 5 - 500 Ω resistance with HV switch in OFF position.
- () Pin 3 to 5 - 500 Ω resistance with HV switch in ON position, MODE switch in CW position.
- () Pin 3 to 5 - 250 Ω resistance with HV switch in ON position, MODE switch in SSB position.
- () Pin 3 to 5 - 500 Ω resistance with HV switch in OFF position, either MODE switch position.
- () Pin 4 to 5 - 650 Ω resistance with all switches OFF.
- () Pin 4 to 5 - 250 Ω resistance with HV switch in ON position, MODE switch in SSB position.
- () Pin 4 to 5 - 650 Ω resistance with HV switch in ON position, MODE switch in CW position.
- () Pin 1 to 6 - infinite resistance in all switch positions.
- () Pin 2 to 6 - infinite resistance in all switch positions.
- () Pin 3 to 6 - infinite resistance in all switch positions.
- () Pin 4 to 6 - infinite resistance in all switch positions.
- () Pin 5 to 6 - infinite resistance in all switch positions.

- () Monitor link to ground - zero resistance.
- () RF output to ground - approximately 4.8 Ω .

The foregoing assumes, of course, that the power supply, whether the Heathkit Model KS-1 or equivalent with similar control circuitry and cabling, has been checked and is in normal working order.

CAUTION!! Make no connections to AC power sources yet.

- () Install RF exciter connection to the grid input receptacle on the rear apron of the KL-1.
- () Connect the high voltage cable to the high voltage coaxial receptacle (other end connected to HV power supply receptacle).
- () Connect the accessory plug to the accessory socket.

NOTE: It is assumed that the kit builder has correctly wired the other end of the accessory cable to the antenna relay, sideband adapter/exciter combination or sideband exciter.

- () Connect an ADEQUATE ground from the ground terminal as short as possible to physical ground. Tie the exciter or exciter/adapter combination cabinet grounds to this ground with large diameter short wires.
- () Connect the dummy load to the RF output coaxial receptacle. The dummy load should be capable of handling 1000 watts for short periods of time.
- () Connect the control socket to the control plug on the KL-1 rear apron (other end to the control socket of the power supply).

Place KL-1 panel controls in the following positions:

- () POWER switch - OFF.
- () TUNE-OPERATE switch - OPERATE.
- () HIGH VOLTAGE switch - OFF.
- () PLATE BAND switch - 80 meters.
- () PLATE LOAD - counterclockwise.
- () PLATE TUNE - any position.
- () MODE switch - SSB.
- () GRID TUNE - zero position.
- () GRID BAND switch - R (resistive load) .
- () METER switch - screen current.
- () BIAS ADJUST - full counterclockwise.

Place EXCITER panel controls as follows:

- () BAND - 80 meters.
- () SIDEBAND - lower.
- () AUDIO GAIN - full counterclockwise.
- () FUNCTION switch - standby.

Carefully read each step through before performing the following:

EXTREME CAUTION!! Connect the exciter and KS-1 or equivalent power supply to the source of AC power. The exciter generally will require 115 V 60 cycle AC, the power supply 230 V 60 cycle AC single phase current.

- () Turn the exciter POWER switch to ON, MODE switch to SSB. The balance of exciter panel control settings are unimportant because no excitation is as yet required. BE SURE the exciter TRANSMIT-STANDBY switch remains in STANDBY position.
- () Now turn the KL-1 POWER switch to ON. In normal operation, the 4-400A and 6DQ6 tube filaments should light, the blower motor should operate and the green power indicator light should light.
- () If faulty operation is experienced, turn POWER switch OFF immediately and see the section IN CASE OF DIFFICULTY.
- () If normal operation is experienced, use a Volt-Ohm-Milliammeter and check the voltage from the bias adjust potentiometer center arm terminal L2 to ground, which should read about -275 volts. Refer to test setup shown in Figure 35A. Use CAUTION in making this check.
- () At the end of 60 seconds, the time delay relay in the power supply (providing the KS-1 or equivalent is used) should close at which time the amber READY light should light.

THIS INDICATES HIGH VOLTAGE IS NOW AVAILABLE WHEN THE HV SWITCH IS THROWN TO ITS ON POSITION. AGAIN USE CAUTION.

- () Now turn the exciter and KL-1 POWER switches OFF and disconnect from the source of AC.
- () Carefully remove the parasitic choke assembly down to the final RF choke. Replace the screw in the capacitor choke strap on top of the RF choke.
- () Carefully remove the 4-400A tubes from their sockets and set aside in a safe place.
- () Referring to test setup in Figure 35E, connect the negative lead of a Volt-Ohm-Milliammeter to the KL-1 chassis. Using an insulated probe, place the probe (positive lead) in pin 2 or 4 of either 4-400A tube socket. Note that there are air holes in the socket which contain no pins. Actual socket pins are numbered according to the insert. Set the meter on its 5000 DC volt scale.
- () Reconnect the AC source of power and turn the exciter and KL-1 POWER switches ON.
- () When the READY light again lights, throw the KL-1 HV switch ON and note the meter reading which should be near +810 volts. If this voltage is correct, proceed; if not, refer to the IN CASE OF DIFFICULTY section.
- () Note the voltage regulator tubes should light as well as the 6DQ6 filaments.
- () Turn the HV switch OFF and change the meter to its 500 volt DC scale. Connect the positive lead to chassis ground and negative probe to pin 3 of either 4-400A tube socket as shown in test setup Figure 35 F, and note the meter reading which should be near -275 volts. If this voltage is correct, proceed; if not, refer to the IN CASE OF DIFFICULTY section.
- () Turn the HV and POWER switch OFF and disconnect the KL-1 from the source of AC.

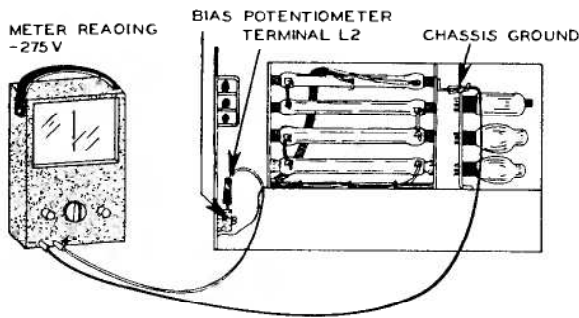

Figure 35A

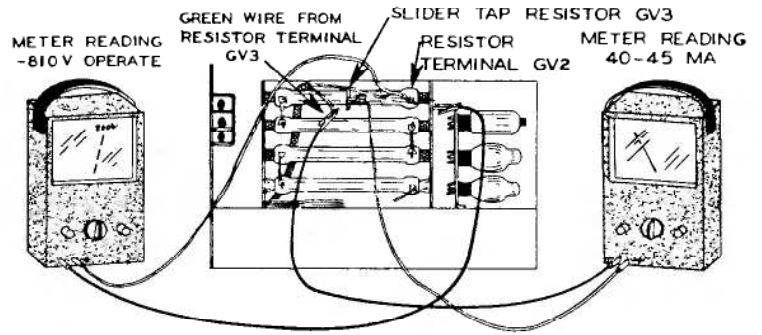

Figure 35B

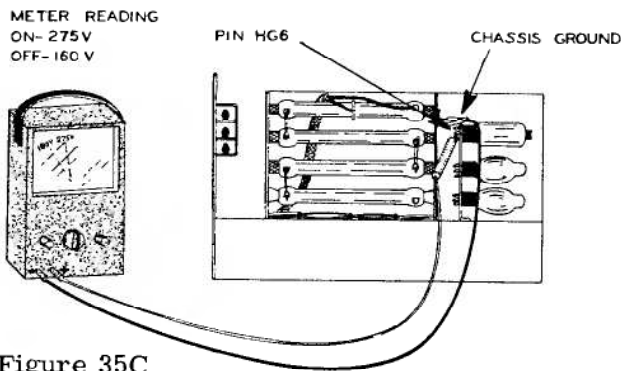

Figure 35C

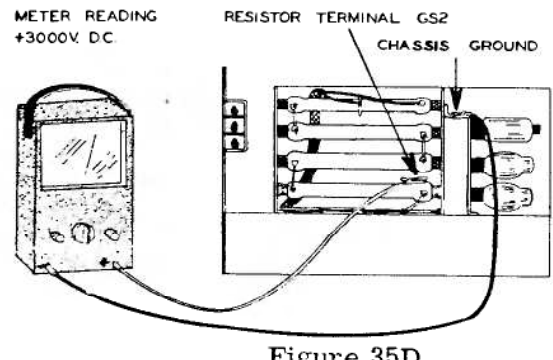

Figure 35D

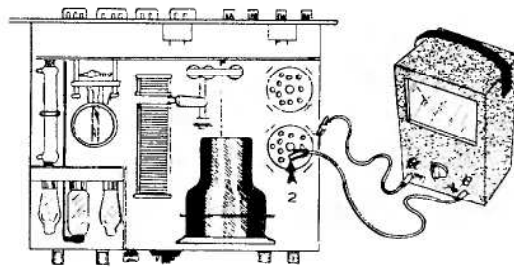

Figure 35E

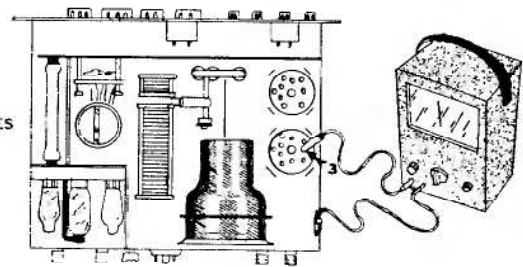
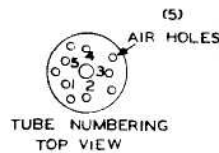

Figure 35F

- () Now carefully replace the 4-400A tubes in their sockets. Replace the parasitic choke assembly and reconnect to the tubes and to the final RF choke. Double check these connections to be sure they will remain mechanically stable.
- () Reconnect the source of AC and turn the POWER switch ON. Again in 60 seconds the READY light should light.
- () Place the KL-1 HV switch in ON position. The RED high voltage indicator light should light, but there should be NO plate current indication. There should be NO grid or screen current indication. The voltage regulator tubes should light. The 6DQ6 filaments should be lit.
- () If any faulty operation is observed, turn the HV switch OFF and refer to the IN CASE OF DIFFICULTY section. If not, proceed with the following steps.
- () With the METER switch in HV position, the meter should read slightly over 3000 volts (when KS-1 is used) if full line voltage is available. Voltage is read on the upper grid scale, using a multiplier of 100.
- () Place the exciter FUNCTION switch in MANUAL position. This should bring no change in previous meter readings except the plate current which should run approximately 85 ma.

SSB BIAS AND SCREEN VOLTAGE SETTINGS

- () With the exciter FUNCTION switch still in MANUAL, rotating the screwdriver bias adjust potentiometer clockwise should increase the plate current. NOW SET THE FRONT PANEL SCREWDRIVER BIAS ADJUST UNTIL THE FINAL PLATE CURRENT READS 180 MILLIAMPERES.

NOTE: It is normal for the 4-400A tubes to show color a few minutes after the bias is set.

- () Now return the exciter to STANDBY position, at which time the KL-1 plate current should return to zero.
- () Turn the KL-1 HV switch OFF.
- () Again referring to test setup shown in Figure 35B, CAREFULLY connect a Volt-Ohm-Milliammeter between chassis ground and screen resistor terminal GV1, using the 1500 volt scale. Disconnecting the wire from the SLIDER on resistor GV, connect another VOM (set at its 150 ma scale) between the slider and the disconnected lead as shown.
- () Turn the exciter and KL-1 HV switch ON. With the TUNE-OPERATE switch in OPERATE position, the voltage should read about +810 volts with current between 40 and 45 ma.
- () Turn the KL-1 HV switch OFF; turn the exciter to STANDBY.

NOTE: If these readings are not within such limits the slider on resistor GV should be adjusted for the readings indicated. Note movement of the slider on resistor GV will adjust the current but has little or no effect on screen voltage.

- () Reconnect the wires loosened for this test.
- () Turn the KL-1 HV switch ON.
- () Check the plate voltage between resistor terminal GS2 and chassis ground. This reading should be at or near 3000 volts DC. See Figure 35D for this test setup.
- () Turn the HIGH VOLTAGE switch OFF.
- () Turn the KL-1 power switch to OFF.
- () Disconnect the meter.

GRID CIRCUIT TUNING FOR CW OPERATION

- () Check to be sure the KL-1 MODE switch is now in CW position.
- () Turn the KL-1 power switch ON and await the READY light indication.
- () Turn the HIGH VOLTAGE switch ON momentarily. The red HV indicator light should NOT light. If any faulty operation is observed, turn the HV switch OFF immediately and refer to IN CASE OF DIFFICULTY section on Page 83. If not, proceed with the following steps.
- () Turn the HV switch OFF.
- () Place the KL-1 METER switch in GRID position.
- () Place the GRID BAND switch in 80-meter position.
- () Place the exciter in CW position, the BAND switch in 80 meters.

- () Obtain grid drive from the exciter as follows:
 - a. Tune driver stages of the exciter in normal fashion.
 - b. Place exciter loading control in minimum position.
 - c. If an exciter TUNE-OPERATE switch is available, place in TUNE position.
 - d. Turn on the exciter final and tune for minimum plate current.
- () Rotate the KL-1 grid tuning control until a maximum of 38 milliamperes grid current is indicated.
- () If peak grid current is less than 38 ma, increase the exciter loading.
- () If peak grid current is more than 38 ma, detune the KL-1 grid tuning control until the proper grid current is indicated.
- () Turn the exciter to STANDBY position.

BIAS SETTING FOR CLASS C OPERATION

- () Connect the positive lead of a Volt-Ohm-Milliammeter to chassis ground, negative lead to pin HG6 of the 6DQ6 clamp tube (this pin has a 33 K Ω 1 watt resistor and a green wire connected to it and can be reached with an insulated probe from the side of the control tube mounting bracket). See test setup shown in Figure 35C.
- () Set the meter to its 500 volt DC range.
- () Turn the exciter to TRANSMIT.
- () It is important that grid current remain 38 ma for this check.
- () The voltage read at this pin should be about -300 volts.
- () Turn the exciter to STANDBY.
- () The voltage read at this pin should drop to about -125 volts.
- () If these voltages are too high or too low, TURN OFF ALL POWER SWITCHES AND REMOVE EXCITER AND POWER SUPPLY CONNECTIONS FROM THE AC MAIN.
- () If the voltages were high, move the slider on bias resistor BP toward the chassis wall and retighten.
- () If the voltages were low, move the slider away from the chassis wall and retighten.
- () Restore the KL-1 to its normal position, reconnect all AC lines.
- () Turn the exciter and KL-1 POWER switches ON.
- () Turn the exciter to TRANSMIT and again observe the meter reading between chassis ground and pin 6 of the 6DQ6 clamp tube.
- () Repeat this procedure, if necessary, until the voltages measured are within normal limits, then turn the exciter to STANDBY and remove the test equipment. This procedure insures correct grid bias for Class C operation.

- () Return the KL-1 to its normal operating position.
- () Now turn the exciter to TRANSMIT and retune the exciter for the remaining bands, 40 through 10 meters.
- () In each position, tune the KL-1 grid circuit as before as a check to see that 38 ma grid drive is obtainable on all bands, indicating proper Class C grid circuit operation. At the higher frequencies it may be necessary to take the exciter out of the TUNE position, if so equipped, in order to obtain proper drive.

NOTE: IT IS NOT NECESSARY to again check grid bias and screen voltages, once the above steps have been checked and found in tolerance. IT IS NOT NECESSARY to change the final BAND switch when making the above grid current checks.

- () Turn the exciter to STANDBY.

Before testing this amplifier, it should be noted here that actual test and operation on the air may be done in the USA or possessions only by persons holding current valid Amateur Operator Licenses issued by the Federal Communications Commission.

Paragraph 12.131 of current U. S. Amateur Regulations regarding maximum authorized power is quoted below:

"Maximum authorized power. Except on frequencies within the band 420-450 mc (where the maximum DC plate power input to the final stage of the transmitter shall not exceed 50 watts), each amateur transmitter may be operated with a power input not exceeding 1 kilowatt to the plate circuit of the final amplifier stage of an amplifier-oscillator transmitter or to the plate circuit of an oscillator transmitter. An amateur transmitter operating with a power input exceeding 900 watts to the plate circuit shall provide means for accurately measuring the plate power input to the vacuum tube or tubes supplying power to the antenna."

CLASS C AMPLIFIER LOADING

- () Equip yourself with a small neon bulb, such as an NE2, in order to check the front panel and chassis for "floating" RF energy due to possible poor ground connections. If RF energy is present, the bulb will light when touching these metal parts, thus indicating further attention to proper grounding is necessary.
- () Return both exciter output and KL-1 grid input circuit to 80 meters.
- () Make certain the KL-1 PLATE BAND switch is set to 80 meters at this time.
- () Obtain proper 80-meter grid drive to the KL-1 as before.
- () Turn the exciter to STANDBY.

NOTE: MAKE SURE PROPER DUMMY LOAD IS CONNECTED TO THE KL-1 RF OUTPUT RECEPTACLE. USE OF AN ANTENNA IS NOT RECOMMENDED SINCE AT ONE OR MORE POINTS IN THE FOLLOWING TESTS, THE AMPLIFIER IS LOADED IN EXCESS OF 1 KILOWATT OF POWER INPUT FOR PURPOSES OF SSB LOADING CHECKS.

- () Set the KL-1 panel controls as follows:
 - a. TUNE-OPERATE switch in TUNE position.
 - b. LOADING control fully counterclockwise.
 - c. METER switch in SCREEN position.
 - d. MODE switch in CW position.

- () Turn the exciter to TRANSMIT.
- () Turn the KL-1 HV switch to ON position and quickly resonate the final plate tuning capacitor to resonance as indicated by minimum plate current.

NOTE: MAKE SURE THE PLATE CURRENT IS MINIMUM since RF arcing may otherwise occur in the final plate tank capacitor when changing the TUNE-OPERATE switch to OPERATE.

- () Place the TUNE-OPERATE switch in OPERATE position.
- () Rotating the LOADING control clockwise in small steps and, maintaining plate resonance (minimum plate current) at each step, continue this procedure until full loading of 300 ma (900 watt input) is obtained.
- () The amplifier is now fully loaded for Class C operation.
- () Screen current should read about 70 milliamperes.
- () Grid current should read 38 milliamperes.
- () Turn the exciter to STANDBY.

NOTE: Turning the exciter final to STANDBY automatically turns off the plate voltage to the KL-1 final amplifier (when using the KS-1 Power Supply with control circuitry as shown in the Schematic) even though the HV switch remains in the ON position.

- () Turn the KL-1 HV switch OFF.
- () Repeat the above loading procedure on all other bands, 40 through 10 meters.
- () Touch up the drive to 38 ma after loading on each band, if required.

NOTE: IN CHANGING BANDS, BE SURE TO TURN THE HV SWITCH OFF AT THE AMPLIFIER BETWEEN CHANGES, RETURN THE TUNE-OPERATE SWITCH TO TUNE AND LOADING CONTROL TO FULL COUNTERCLOCKWISE BEFORE TUNING UP ON EACH BAND. BOTH BAND SWITCHES MUST BE ON THE SAME BAND, AND THE METER SWITCH RETURNED TO GRID POSITION FOR GRID CURRENT READINGS.

- () Make the neon bulb to chassis and panel check on each succeeding band for RF energy indication. Correct for adequate ground, if necessary.
- () Turn the exciter to STANDBY.
- () Turn the KL-1 HV switch OFF.

NOTE: This completes all tests for proper final tank circuit operation in Class C except neutralization which will be covered in a separate section to follow.

SSB AMPLIFIER "R" GRID CIRCUIT TUNING

NOTE: If your exciter has a power output capacity of 65 watts or more, the following tests will check the proper operation of the resistive or untuned grid circuit position indicated on the KL-1 GRID BAND switch as "R".

- () Connect the output of an audio generator to the input of the exciter (or exciter/adapter combination) as the case may be.
- () Set the audio generator to a 30 millivolt output level and the frequency at 1000 cycles.

() Set the KL-1 panel controls as follows:

- a. TUNE-OPERATE switch to OPERATE.
- b. MODE switch to SSB.
- c. GRID BAND switch to "R".
- d. METER switch to GRID.
- e. PLATE BAND switch to 80 meters.
- f. HV switch to OFF.
- g. PLATE LOADING to 0.

() Set exciter, or exciter/adaptor combination, controls as follows:

- a. BAND switch to 80 meters.
- b. MODE switch to SSB.
- c. SIDEBAND to LOWER sideband.
- d. FUNCTION switch to STANDBY.

() Now load the exciter in normal manner, using inserted carrier as a single tone test until between 5 ma and 10 ma of KL-1 grid current is indicated. (Audio may be used instead of inserted carrier, if desired.)

() In no event exceed 38 ma grid current (maximum rating for two tubes).

() Suppress the inserted carrier (if inserted carrier was used), or turn the audio gain control down if audio was used.

This completes the test of the resistive input driving circuit. If you are using a low power exciter not capable of driving the final amplifier as above, it is suggested that the tuned grid circuit tuning technique described previously for CW operation be used. Tune for 5 to 10 ma of grid current, as before, and proceed as follows:

SSB AMPLIFIER LOADING AND TWO-TONE TEST

() Generate a two-tone test signal in the exciter by selecting the double sideband position on the exciter and inserting the 1000 cycle tone. Keep the audio gain control fully counter-clockwise.

NOTE: If the exciter used does not have provision for double sideband operation, the two-tone test can then be made in either SSB position by inserting TWO audio tones separated by 1000 cycles to obtain similar results.

() Place the HV switch in ON position.

() Placing the exciter or exciter/adaptor combination FUNCTION switch in MANUAL, advance AUDIO GAIN control until there is a slight increase in plate current from the 180 ma resting value. Then resonate the final (minimum plate current).

() Proceed to load the final amplifier by increasing both plate loading and audio gain, as required, maintaining plate tank resonance (minimum plate current) with the plate tuning control until a plate current of 430 milliamperes and SCREEN current of 8 milliamperes maximum are indicated.

NOTE: Notice that comparatively little excitation is required and that excitation and loading have a pronounced effect on screen current. The screen current is actually a very sensitive indication of proper load conditions.

- () Turn the exciter or exciter/adaptor combination FUNCTION switch to STANDBY.
- () Turn the HV switch OFF.
- () Remove the two-tone test signal.

This completes the testing for normal Class AB1 operation.

NEUTRALIZATION PROCEDURE

If a grid dip oscillator is not available and the 1 1/2" overall length of neutralizing stub was chosen, this predetermined length has been found to produce excellent neutralizing results. To do a more perfect job, however, the 1 3/4" length of the neutralizing stub is purposely long and can be gradually shortened, using a grid dip oscillator in DIODE position to check the neutralization as follows:

- () Place the KL-1 panel controls in the following positions:
 - a. METER switch in GRID position.
 - b. GRID BAND switch in 10-meter position.
 - c. GRID tuning in any position.
 - d. MODE switch in CW position.
 - e. FINAL tuning in any position.
 - f. FINAL BAND switch in 10-meter position.
 - g. Loading in full counterclockwise position.
 - h. POWER switch ON.
 - j. TUNE-OPERATE switch in TUNE position.
 - k. HV switch OFF.
- () Now tune the exciter for drive on 10 meters in the center of the band.
- () Turn the exciter to TRANSMIT and resonate its final.
- () Tune the KL-1 GRID TUNE control for 38 ma of grid drive, as previously described.

NOTE: The KL-1 HV switch is NOT turned to ON for this procedure.

- () Keeping the grid dip oscillator in DIODE position, tune the instrument to the amplifier frequency, loosely coupling to the 10-meter plate tank coil.
- () Resonate the KL-1 plate tuning and the grid dip oscillator for maximum reading.

NOTE: It is important to keep the coupling constant between oscillator and plate tank coil as it is the relative reading between steps which dictates whether more or less neutralizing energy is necessary. Try, therefore, to set the grid dip oscillator in a position where you won't need to move it between steps.

- () Note the reading of the grid dip oscillator scale.
- () Turn the exciter to STANDBY.
- () Clip off between 1/16" and 1/8" from the neutralizing stub.
- () Turn the exciter ON and again note the reading on the grid dip oscillator scale.
 - a. If this reading is less, you are proceeding in the right direction.
 - b. If this reading is higher, the stub must be made longer. If so, the exciter should be turned to STANDBY, the stub removed and a new, longer piece of wire inserted and the previous steps repeated.
- () Turn the exciter to STANDBY and again clip 1/16" to 1/8" from the neutralizing stub.
- () Turn the exciter ON and note the grid dip oscillator reading to see if it is again lower.
- () When the grid dip oscillator's lowest reading is reached, the amplifier may be considered neutralized.
- () Turn the exciter OFF.
- () Turn the KL-1 power OFF.

This completes the neutralizing procedure.

- () Remove all cable and ground connections.
- () Inspect all mechanical details to be sure all of these details are satisfactory prior to installing in the cabinet.

FINAL INSTALLATION

OPERATION AND LOADING

Use every precaution in operating. Although this amplifier is designed for safe operation, do not lose respect for its lethal capabilities.

CW

Set the front panel controls as outlined below:

Meter Switch	Grid
Grid Band.....	Desired Band
Mode Switch.....	CW
Plate Tune.....	5
Plate Load.....	0
Band Switch	Desired Band
Power	On
Tune Operate Switch.....	Tune
High Voltage Switch	Off

- () Tune your exciter to apply a small amount of carrier to the KL-1. (Note - less than 40 watts of driving power is needed to fully load the KL-1 on 10 meters. Take care, however, not to exceed 38 ma grid drive.)
- () Tune the Grid Tune control for maximum grid current but not in excess of 38 ma.
- () Increase the drive from the exciter, keeping the Grid Tune control tuned to maximum grid current, until 38 ma is reached.
- () Turn the high voltage switch to ON and tune the Plate Tune control for resonance, indicated by dip in plate current.
- () Turn the tune operate switch to OPERATE.
- () Turn the plate load control clockwise, maintaining plate current resonance with the Plate Tuning control, until the plate current reaches 300 ma (900 watts input with a plate voltage of 3000 volts).
- () The KL-1 is now fully loaded and ready for CW operation. While at this load the screen current should read about 70 ma.

SSB

Set the front panel controls as outlined below:

Meter Switch	Grid
Grid Band	
High power exciters (60 to 150 watt PEP output)..	R
Low power exciters (10 to 20 watt PEP output) ..	Desired Band
Mode Switch	SSB
Plate Tune	5
Plate Load	0
Band Switch.....	Desired Band
Power	On
Tune Operate Switch	Operate
High Voltage Switch.....	Off

High Power Exciter:

- () With full carrier inserted, load your exciter into the KL-1 until 5 to 10 ma of grid current flows.
- () Suppress the inserted carrier and, with the audio gain OFF turn the high voltage ON and the exciter to manual. The plate current should now read 180 ma.
- () Insert enough carrier to increase the KL-1 plate current to about 300 ma.
- () Tune the Plate Tune control for resonance, indicated by a dip in plate current.
- () Increase the amount of inserted carrier until a slight amount (1/2 to 1 ma) of grid current is drawn by the KL-1.
- () Turn the meter switch to screen.
- () Turn the Plate Load control clockwise, maintaining plate current resonance with the Plate Tuning control, until the plate current reaches 660 ma (2000 watts input with a plate voltage of 3000 volts). The screen current should now read about 40 ma. Load quickly since the plate dissipation of the 4-400A's is exceeded during this loading procedure.
- () Turn the High Voltage OFF.
- () Suppress the carrier and turn the exciter to VOX.
- () Turn the High Voltage ON. The KL-1 is now fully loaded and ready for SSB suppressed carrier operation.
- () Audio gain may now be applied. Depending on individual voice characteristics, the audio gain should be set so indicated plate current peaks run between 260 and 330 ma.

Low Power Exciter:

- () With full carrier inserted, load your exciter into the KL-1. Tune the Grid Tune control for maximum grid current (1 to 10 ma should be obtained).
- () Follow steps 2 through 11 for High Power Exciter.

NOTE: During operation with either high or low power exciter the grid current remains zero at all times and the screen current should kick negative, rising only slightly when peaks of maximum power are hit. Depending on individual voice characteristics, the plate current of the KL-1 will kick to between 260 and 330 ma before any flat topping is observed.

AM Linear:

For operation as an AM Linear, set the front panel controls for SSB operation.

- () Depending on your exciter, follow either the high or low power exciter loading procedure (steps 1 through 10) for SSB.
- () Reinsert carrier until a plate current of 330 ma (1000 watts at a plate voltage of 3000 volts) is reached. Note: The plate current is one half the current drawn if full carrier is inserted, but is the maximum carrier level that the linear can handle and provide 100% modulation capabilities.

During operation the grid and screen currents are zero and the plate current is constant (does not kick on modulation). Percentage modulation should be checked on an oscilloscope to prevent overmodulation in AM service.

SOME OPERATING REMINDERS

DO make certain the GRID and PLATE BAND switches are on the same band when operating.

Do remember when the untuned (R) grid position is selected, no grid tuning or grid band switching is required.

DO remember the untuned (R) grid position may be used only for Class AB1 operation whereas the tuned grid position may be used for both Class C and Class AB1 operation.

DO remember to turn the HV switch OFF when changing bands.

DO remember an Amateur License of the proper grade is required to operate this unit.

DO remember to stay within your Amateur regulations regarding power. See quoted U. S. regulations in section on PRELIMINARY TESTING on Page 65.

DO make certain your exciter signal is of good quality, since any signal fed to the amplifier will be amplified including magnification of any poor qualities inherent in the exciter.

USE CAUTION ON ALL TESTS. Work with power OFF if at all possible. Measurements made with a Heathkit MM-1 VOM (20,000 ohms/volt).

SYMPTOM	POSSIBLE CAUSE	TEST CHECKS
No power. No READY light. No blower operation.	1. Control <u>circuit</u> wiring error. 2. Control <u>cable</u> wiring error. 3. Blower leads not connected. 4. Blower leads open circuited.	1. Check control <u>circuit</u> wiring. 2. Check control cable wiring, pins 3 and 5. 3. Check physical connection. 4. Check for continuity.
No bias voltage present at bias adjust terminal L2. No bias voltage present at tube socket pin 3.	1. Bias transformer primary wiring error. 2. Secondary wiring error. 3. Diodes miswired. 4. Open filter capacitors. 5. Open choke. 6. Open potentiometer.	1. Check primary for continuity and AC voltage. 2. Check secondary for continuity and AC voltage. 3. Check diodes for proper polarity. 4. Check filter capacitors for open reading. 5. Check choke for continuity. 6. Check potentiometer for continuity.
Screen voltage excessively high.	1. Open voltage regulator string.	1. Check voltage regulator mounting bracket wiring.
No high voltage. No red light.	1. Control wiring error. 2. Control cable wiring error. 3. Control relay wiring error. 4. MODE switch in CW position.	1. Check control wiring, pins 4 to 2. 2. Check control <u>cable</u> wiring, pin 4. 3. Check wiring to control <u>relay</u> contact terminals. 4. MODE switch function now controlled by exciter.
HV indicator lights in CW position with exciter in <u>STANDBY</u> .	1. MODE switch wiring error. 2. Control relay wiring error. 3. Accessory socket wiring error.	1. Check MODE switch wiring, especially leads to the control relay. 2. Check control relay wiring. 3. Check accessory socket wiring, especially leads to the control relay coil.

SYMPTOM	POSSIBLE CAUSE	TEST CHECKS
Bias voltage <u>low</u> .	1. Wrong setting of bias resistor BP slider.	1. Move slider <u>away</u> from chassis wall and retighten (see section on PRELIMINARY TESTING).
Bias voltage high.	1. Wrong setting of bias resistor BP slider.	1. Move slider <u>toward</u> chassis wall and retighten (see section on PRELIMINARY TESTING).
No screen voltage.	1. Open screen resistors. 2. MODE switch wiring error. 3. TUNE-OPERATE switch wiring error.	1. Check each resistor for continuity. 2. Trace wiring from screen resistors to MODE switch. 3. Trace wiring from TUNE-OPERATE switch to screen resistors.
Control relay inoperative.	1. Open relay primary. 2. Lack of 115 V AC at primary. 3. MODE switch wiring error.	1. Check relay coil for open winding. 2. Check to determine if 115 V AC is present at the primary with exciter control ON. 3. Trace MODE switch to accessory socket wiring.
High resting plate current in SSB.	1. Bias not correctly set.	1. Reset bias according to section on PRELIMINARY TESTING.
Screen current too low.	1. Screen voltage low. 2. Bias set incorrectly.	1. Reset screen resistor tap according to section on PRELIMINARY TESTING. 2. Check voltage regulators and voltage. 3. Reset bias according to section on PRELIMINARY TESTING. 4. Recheck wiring of voltage regulators and voltage.
Unable to load or set proper SSB resting plate current.	1. TUNE-OPERATE switch in <u>TUNE</u> position.	1. Place TUNE-OPERATE switch in <u>OPERATE</u> position.

SYMPTOM	POSSIBLE CAUSE	TEST CHECKS
No drive - tuned GRID position.	<ol style="list-style-type: none"> 1. Faulty meter shunt. 2. Improper band selection. 3. GRID BAND switch wiring error. 	<ol style="list-style-type: none"> 1. Check meter shunt for continuity and resistance of 1.02 Ω. 2. Reset GRID BAND switch to proper band. 3. Trace GRID BAND switch wiring and check continuity.
No bias in CW position.	<ol style="list-style-type: none"> 1. Open or improper grid circuit wiring. 2. Bias supply not operative. 	<ol style="list-style-type: none"> 1. Check each component in grid circuit of 4-400A's to be sure none are open or shorted. 2. Check bias supply components and circuit wiring.
Unable to resonate final tank.	<ol style="list-style-type: none"> 1. Incorrect BAND switch taps or wiring. 2. Loose or open BAND switch connection. 3. Loose tuning capacitor connections. 	<ol style="list-style-type: none"> 1. Check BAND switch taps against front panel rotation. This is a shorting type switch. 2. Check coil taps to BAND switch for solid mechanical and electrical connections. 3. Check 10-meter coil tap to tuning capacitor connection.
High plate current with key up in CW position.	<ol style="list-style-type: none"> 1. Bias not correctly set. 2. 6DQ6 clamp tube not operative. 	<ol style="list-style-type: none"> 1. Reset bias according to section on PRELIMINARY TESTING. 2. Check for wiring error to 6DQ6 clamp tube. 3. Check voltages as given in section on PRELIMINARY TESTING.
RF on chassis as indicated when using a neon bulb.	<ol style="list-style-type: none"> 1. Poor ground connection. 2. Parasitic oscillation. 	<ol style="list-style-type: none"> 1. Check for adequate ground connection as discussed under GROUND CONNECTIONS. Correct condition and recheck. 2. Circuit layout modified from that shown - return to original layout. 3. Check parasitic chokes in grid, screen and plate circuits for evidence of open choke or open resistor.

SYMPTOM	POSSIBLE CAUSE	TEST CHECKS
Instability.	<ol style="list-style-type: none"> <li data-bbox="529 205 927 237">1. Not properly neutralized. <li data-bbox="529 331 927 384">2. Unsoldered connections - cold solder joints. 	<ol style="list-style-type: none"> <li data-bbox="1021 197 1508 289">1. Reneutralize, following section on NEUTRALIZATION PROCEDURE. <li data-bbox="1021 321 1393 384">2. Reheat connections and recheck.

For voltage and resistance measurements, see the Schematic and refer to section on PRELIMINARY TESTING.

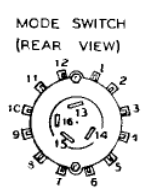
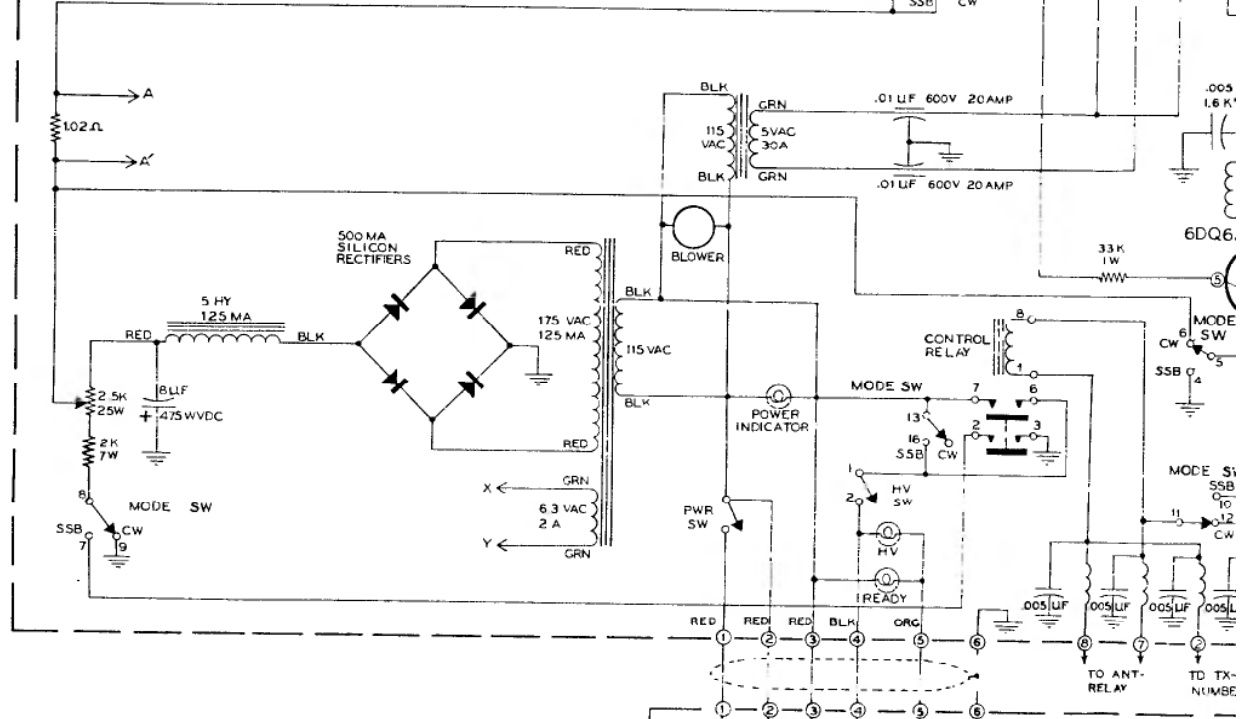
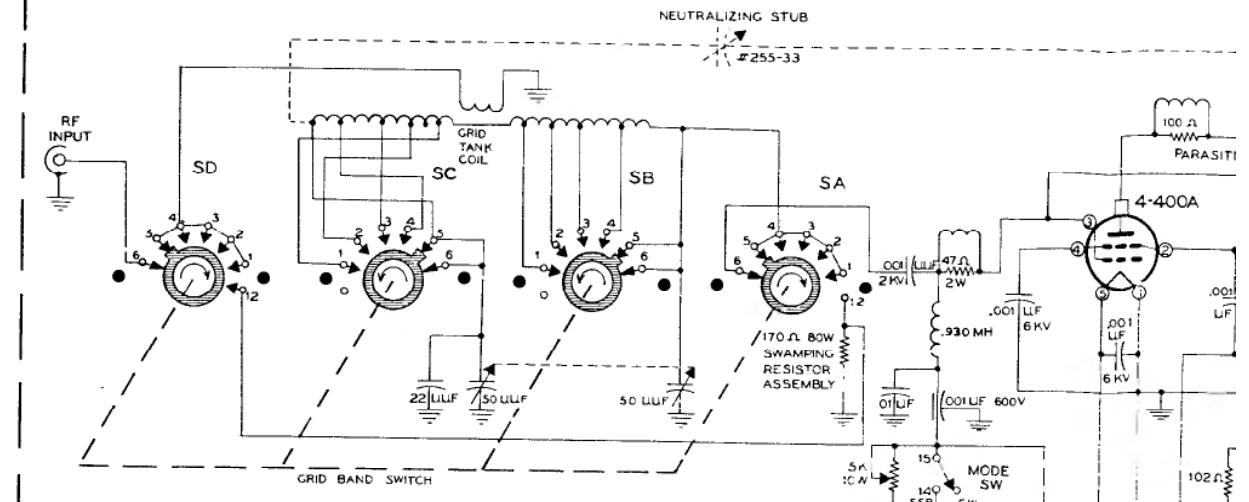

SHAFT FLAT 180° FROM TERMINAL 1 WHEN SWITCH IS IN COUNTER-CLOCKWISE POSITION.

230 VAC
3 WIRE
SINGLE PHASE

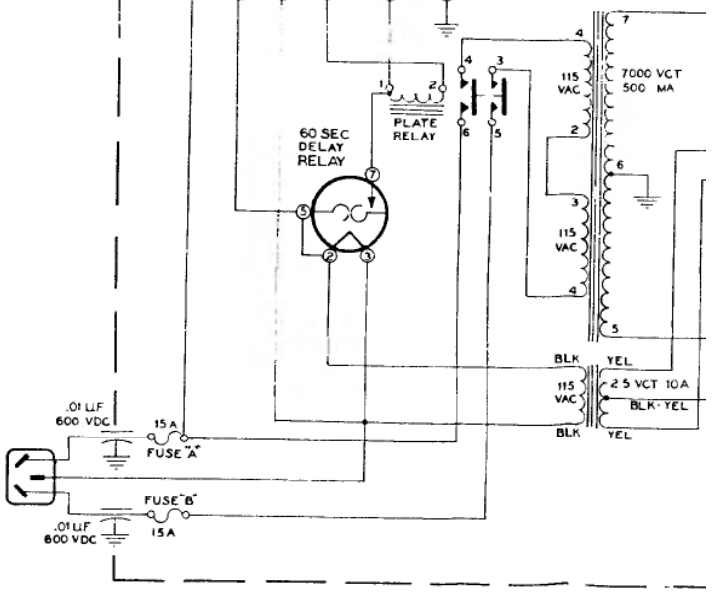

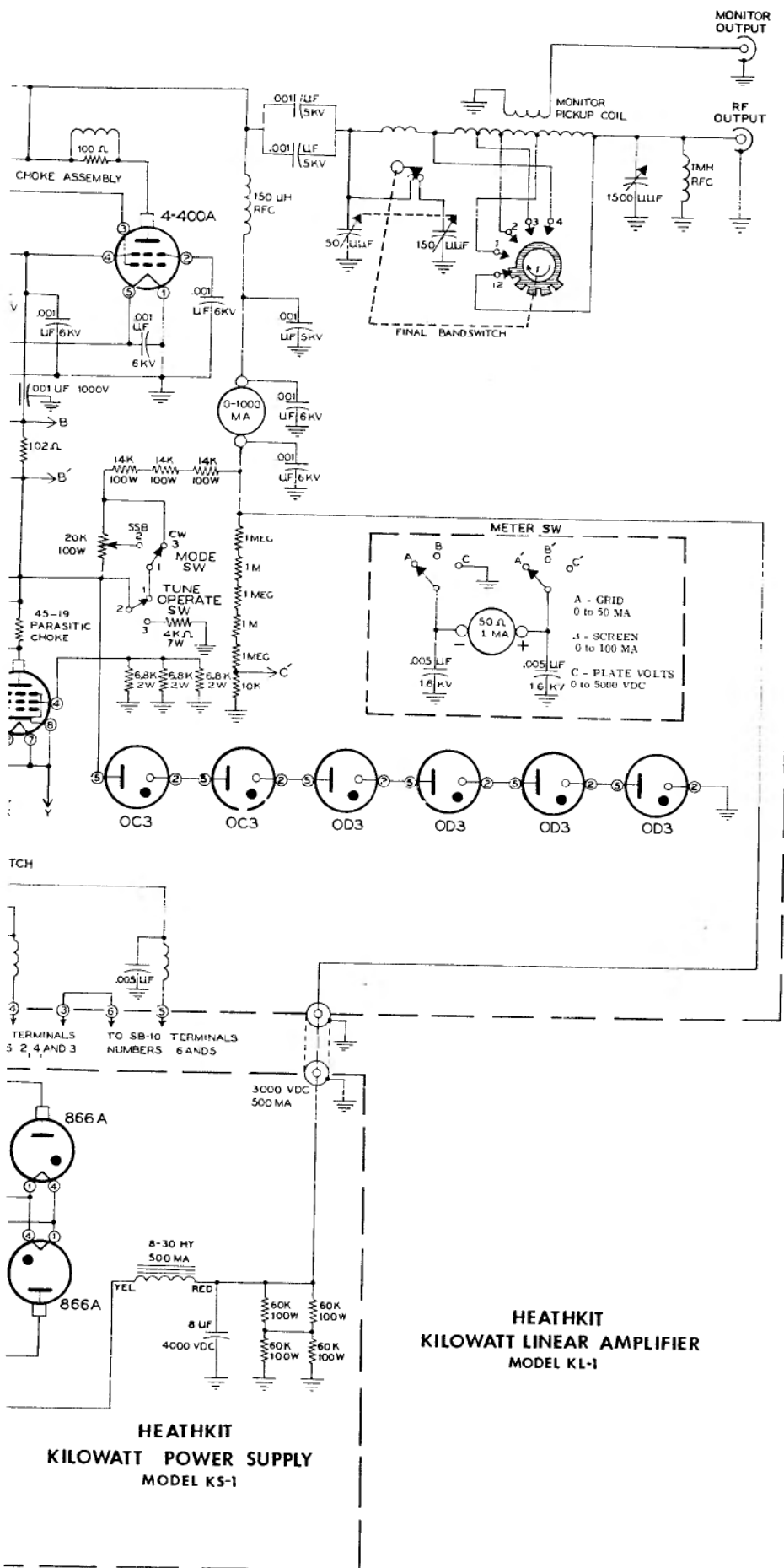

**HEATHKIT
KILOWATT LINEAR AMPLIFIER
MODEL KL-1**

**HEATHKIT
KILOWATT POWER SUPPLY
MODEL KS-1**