

PRICE \$2.00

HEATH COMPANY • BENTON HARBOR, MICHIGAN

# HEATHKIT® ASSEMBLY MANUAL



## LINE VOLTAGE MONITOR

MODEL IM-103

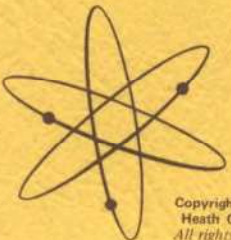

Copyright © 1970  
Heath Company  
All rights reserved

595-1241

Assembly  
and  
Operation  
of the



# LINE VOLTAGE MONITOR

MODEL IM-103

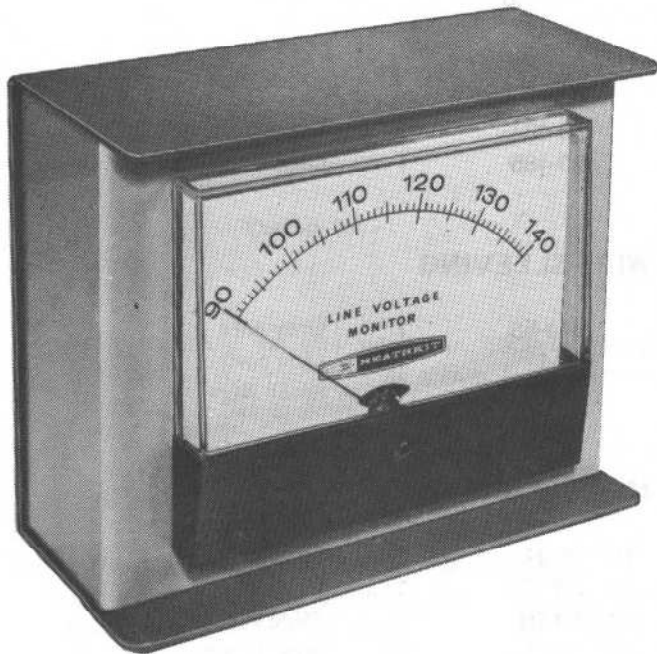

## TABLE OF CONTENTS

Introduction . . . . .	2
Parts List . . . . .	2
Step-By-Step Assembly . . . . .	3
Initial Test . . . . .	7
Final Assembly . . . . .	8
Adjustments . . . . .	9
In Case of Difficulty . . . . .	9
Troubleshooting Chart . . . . .	10
Specifications . . . . .	11
Circuit Description . . . . .	12
Chassis Photograph . . . . .	13
Schematic . . . . .	13
Replacement Parts Price List . . . . .	14
Factory Repair Service . . . . .	15

HEATH COMPANY  
BENTON HARBOR, MICHIGAN 49022

Dear Customer:

You have just purchased one of the best performing electronic products in the world – your Heathkit.

Here's how we aim to keep it that way:

### Your Heathkit Warranty

During your first 90 days of ownership, any parts which we find are defective, either in materials or workmanship, will be replaced or repaired free of charge. And we'll pay shipping charges to get those parts to you – anywhere in the world.

If we determine a defective part has caused your Heathkit to need other repair, through no fault of yours, we will service it free – at the factory, at any retail Heathkit Electronic Center, or through any of our authorized overseas distributors.

This protection is exclusively yours as the original purchaser. Naturally, it doesn't cover damage by use of acid-core solder, incorrect assembly, misuse, fire, flood or acts of God. But, it does insure the performance of your Heathkit anywhere in the world – for most any other reason.

### After-Warranty Service

What happens after warranty? We won't let you down. If your Heathkit needs repairs or you need a part, just write or call the factory, your nearest retail Heathkit Electronic Center, or any Heath authorized overseas distributor. We maintain an inventory of replacement parts for each Heathkit model at most locations – even for models that no longer appear in our current product line-up. Repair service and technical consultation is available through all locations.

We hope you'll never need our repair or replacement services, but it's nice to know you're protected anyway – and that cheerful help is nearby.











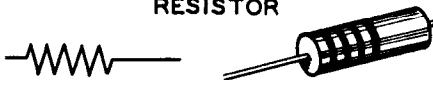

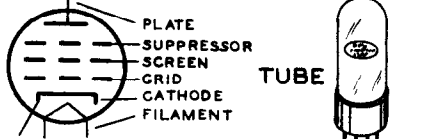
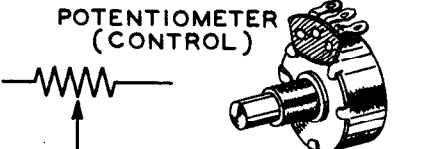
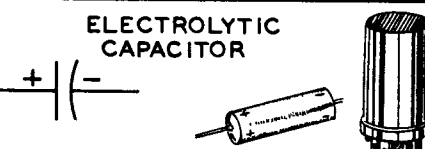
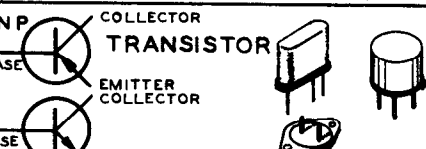
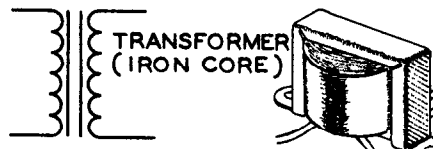
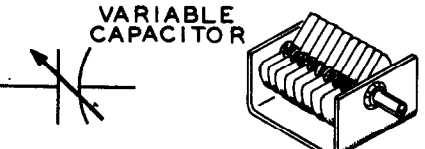
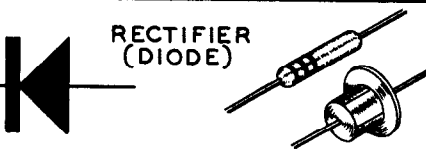
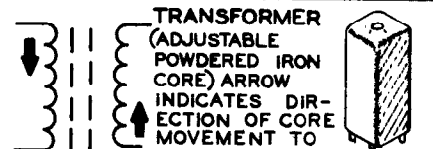
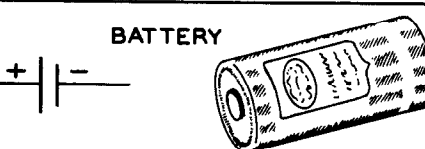
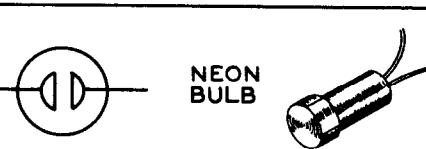
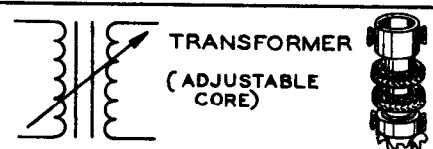
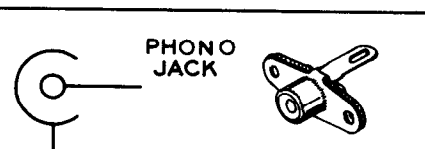
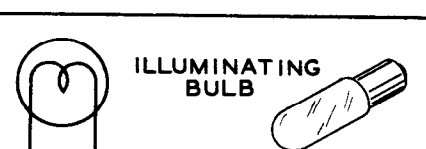
Sincerely,

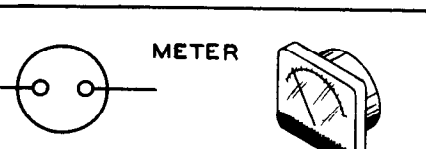
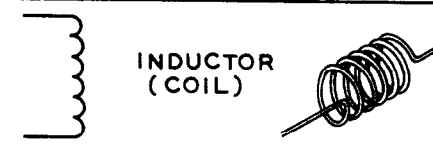
HEATH COMPANY  
Benton Harbor, Michigan 49022

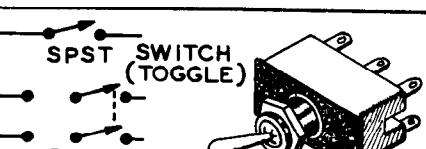
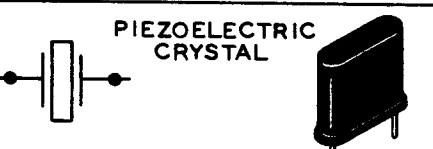
## TYPICAL COMPONENT TYPES

This chart is a guide to commonly used types of electronic components. The symbols and related illustrations

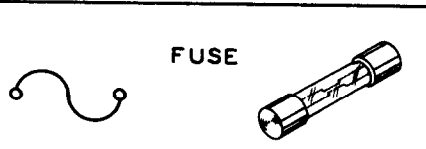
should prove helpful in identifying most parts and reading the schematic diagrams.

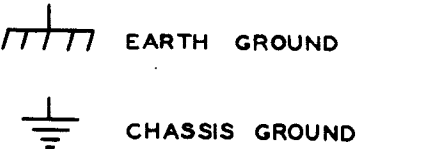
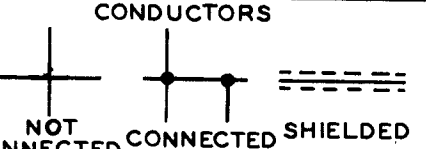
<p style="text-align: center;"><b>RESISTOR</b></p> 	<p style="text-align: center;"><b>CAPACITOR</b></p> 	<p style="text-align: center;"><b>TUBE</b></p> 
<p style="text-align: center;"><b>POTENTIOMETER (CONTROL)</b></p> 	<p style="text-align: center;"><b>ELECTROLYTIC CAPACITOR</b></p> 	<p style="text-align: center;"><b>TRANSISTOR</b></p> 
<p style="text-align: center;"><b>TRANSFORMER (IRON CORE)</b></p> 	<p style="text-align: center;"><b>VARIABLE CAPACITOR</b></p> 	<p style="text-align: center;"><b>RECTIFIER (DIODE)</b></p> 
<p style="text-align: center;"><b>TRANSFORMER (ADJUSTABLE POWDERED IRON CORE) ARROW INDICATES DIRECTION OF CORE MOVEMENT TO INCREASE INDUCTANCE</b></p> 	<p style="text-align: center;"><b>BATTERY</b></p> 	<p style="text-align: center;"><b>NEON BULB</b></p> 
<p style="text-align: center;"><b>TRANSFORMER (ADJUSTABLE CORE)</b></p> 	<p style="text-align: center;"><b>PHONO JACK</b></p> 	<p style="text-align: center;"><b>ILLUMINATING BULB</b></p> 
<p style="text-align: center;"><b>POWER TRANSFORMER</b></p> 	<p style="text-align: center;"><b>PHONE JACK</b></p> 	<p style="text-align: center;"><b>METER</b></p> 
<p style="text-align: center;"><b>INDUCTOR (COIL)</b></p> 	<p style="text-align: center;"><b>RECEPTACLE</b></p> 	<p style="text-align: center;"><b>SPST SWITCH (TOGGLE)</b> <b>DPDT</b></p> 
<p style="text-align: center;"><b>PIEZOELECTRIC CRYSTAL</b></p> 	<p style="text-align: center;"><b>SPEAKER</b></p> 	<p style="text-align: center;"><b>SWITCH (ROTARY)</b></p> 
<p style="text-align: center;"><b>BINDING POST</b></p> 	<p style="text-align: center;"><b>MICROPHONE</b></p> 	<p style="text-align: center;"><b>FUSE</b></p> 
<p style="text-align: center;"><b>ANTENNA</b></p> <p style="text-align: center;">GENERAL      LOOP</p> 	<p style="text-align: center;"><b>EARTH GROUND</b></p> <p style="text-align: center;"><b>CHASSIS GROUND</b></p> 	<p style="text-align: center;"><b>CONDUCTORS</b></p> <p style="text-align: center;">NOT CONNECTED      CONNECTED      SHIELDED</p> 

## INTRODUCTION

The Heathkit Model IM-103 Line Voltage Monitor uses a bridge circuit with an easy-to-read, expanded-scale meter to enable you to continuously and accurately monitor power line voltage. A built-in calibration circuit allows you to calibrate the Monitor using only the line voltage to read within  $\pm 5\%$  accuracy. When it is calibrated at the specified voltages (95 and 135 VAC) from an accurate voltage source, the Monitor will maintain an accuracy of  $\pm 2\%$ .

Rubber feet can be mounted on the rear or the bottom of the cabinet to allow the unit to sit upright or lie flat. The Monitor can also be wall-mounted by means of the mounting hole on the rear of the cabinet.

*Refer to the "Kit Builders Guide" for complete information on unpacking, parts identification, tools, wiring, soldering, and step-by-step assembly procedures.*

## PARTS LIST

Check each part against the following Parts List. The key numbers correspond to the numbers in the Parts Pictorial.

KEY PART No.	PARTS No.	PER KIT	DESCRIPTION
-----------------	--------------	---------	-------------

### RESISTORS

#### 1% Precision, 1/2 Watt

1	2-121	1	3600 $\Omega$ (3.6 k)
	2-35	1	9000 $\Omega$ (9 k)
	2-176	1	4500 $\Omega$ (4.5 k)

#### Other Resistors

	2-94-1	1	18 k $\Omega$ precision, 1 watt
2	1-23	1	27 k $\Omega$ (red-violet-orange), 1/2 watt
3	1-20-2	1	100 $\Omega$ (brown-black-brown), 2 watt
	1-3-2	1	10 k $\Omega$ (brown-black-orange), 2 watt

### CAPACITOR-CONTROLS

4	25-43	1	70 $\mu$ F electrolytic capacitor
5	10-51	1	5000 $\Omega$ control (5 k)
	10-284	1	20 k $\Omega$ control

### DIODES

6	56-36	1	Zener diode
7	56-56	1	1N4149 silicon diode
8	57-27	1	1N2071 silicon diode

### HARDWARE

9	250-116	2	6-32 x 1/4" black screw
10	250-369	4	#6 x 1/4" black sheet metal screw

To order replacement parts, refer to the "Replacement Parts Price List" and use the Parts Order Form furnished with this kit.

KEY PART No.	PARTS No.	PER KIT	DESCRIPTION
-----------------	--------------	---------	-------------

### TERMINAL STRIP

11	431-87	1	20-lug terminal strip
----	--------	---	-----------------------

### METAL PARTS

90-484	1	Cabinet front
90-485	1	Cabinet back

### WIRE-SLEEVING

344-58	1	Gray wire
89-1	1	Line cord
346-1	1	Smell sleeving

### MISCELLANEOUS

12	75-24	1	Strain relief
13	207-72	1	Cable clamp
14	60-20	1	Slide switch
15	261-29	4	Plastic foot
16	407-156	1	Meter
17	75-90	1	Insulation paper
	391-34	1	Blue and white label
	597-260	1	Parts Order Form
	597-308	1	Kit Builders Guide
		1	Manual (See front cover for part number.)
			Solder

## STEP-BY-STEP ASSEMBLY

Before starting to assemble this kit, be sure you have read the wiring, soldering, and step-by-step assembly information in the "Kit Builders Guide."

Refer to Pictorial 1 (fold-out from Page 5) for the following steps.

**NOTE:** Use 1/2 watt resistors unless the step directs otherwise. All resistors will be called out by the resistance value (in  $\Omega$  or  $k\Omega$ ) and the color code. Capacitors will be called out by capacitance value and type.

Place a soft cloth over your work area to keep the cabinet front and meter face from being scratched.

- ( ) Position the cabinet front as shown in Pictorial 1.

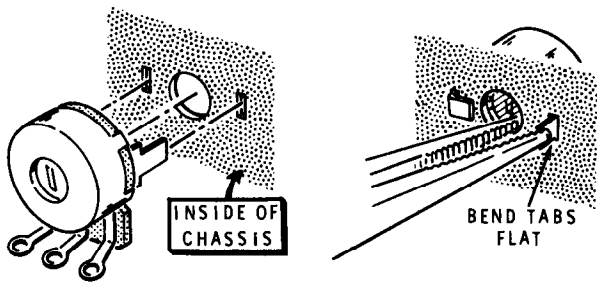

**Detail 1A**

- ( ) Refer to Detail 1A and mount the 5000  $\Omega$  control (#10-51) at A. Position it as shown in Pictorial 1. Bend the tabs flat, as shown.
- ( ) In a similar manner, install the 20  $k\Omega$  control (#10-284) at B.

**NOTE:** When a wire passes through (or wraps around) a connector and then goes to another point, it will count as two wires in the solder instructions (S-2), one entering and one leaving the connection.

- ( ) Prepare a 3-1/4" gray wire by removing 1/2" of insulation from one end and 1/4" from the other end.
- ( ) Pass the end of the wire with 1/2" of insulation removed through lug 3 (S-2) to lug 2 (S-1) of control A.
- ( ) Connect the other end of this wire to lug 1 of control B (NS).

**NOTE:** When you are instructed to prepare a wire in any of the following steps, cut the wire to the specified length and (unless otherwise directed) remove 1/4" of insulation from each end.

- ( ) Prepare a 5-1/4" gray wire and a 4" gray wire.
- ( ) Connect one end of the 5-1/4" wire to lug 1 of control B (S-2). The other end will be connected later.
- ( ) Connect one end of the 4" wire to lug 1 of control A (S-1). The other end will be connected later.
- ( ) Pass one lead of a 27  $k\Omega$  (red-violet-orange) resistor through lug 3 (S-2) to lug 2 (S-1) of control B. The other end will be connected later.
- ( ) Refer to Detail 1B and install the slide switch at location C using 6-32 x 1/4" screws.

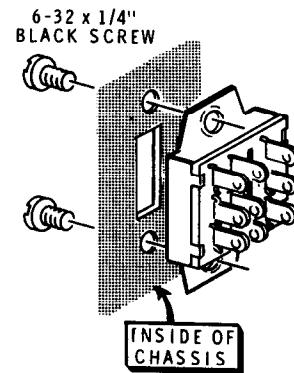

**Detail 1B**

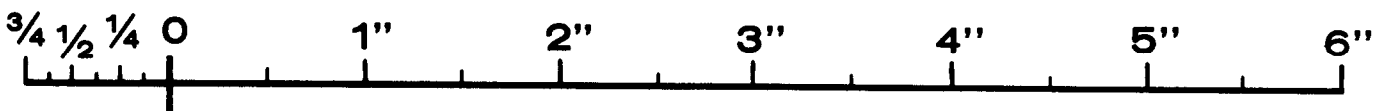

- ( ) Prepare the following lengths of gray wire by removing 3/8" of insulation from each end (3/8" needed to hold wires on terminals before they are soldered). NOTE: The wires are listed in the order in which they will be used.

7-1/4"	6-1/4"
4"	3-3/4"
2-3/4"	7/8" (Remove all insulation.)
3-1/2"	3-1/2"

Connect one end of each of these wires to slide switch C as directed below. The other end of each wire will be connected later.

<u>WIRE</u>	<u>CONNECT TO</u>
( ) 7-1/4"	lug 9 (S-1)
( ) 4"	lug 6 (S-1)
( ) 2-3/4"	lug 3 (S-1)
( ) 3-1/2"	lug 8 (S-1)
( ) 6 1/4"	lug 5 (S-1)
( ) 3-3/4"	lug 2 (S-1)
( ) 7/8"	lug 7 (S-1) and lug 4 (S-1)
( ) 3-1/2"	lug 1 (S-1)

- ( ) Bend all of the wires and the 27 kΩ resistor out of the area of the meter opening.

Refer to Pictorial 2 for the following steps.

- ( ) Carefully unpack the meter and the hardware supplied with it. Place the meter face down and position it as shown.
- ( ) Place the cabinet front on the meter, making sure that all four mounting screws pass through the cabinet front.
- ( ) Install nuts and lockwashers (supplied with the meter) at AA, AB, and AD. Do not tighten the nuts.
- ( ) Slide a plastic cable clamp over the 70 μF electrolytic capacitor. Position the clamp and the positive (+) end of the capacitor, as shown.

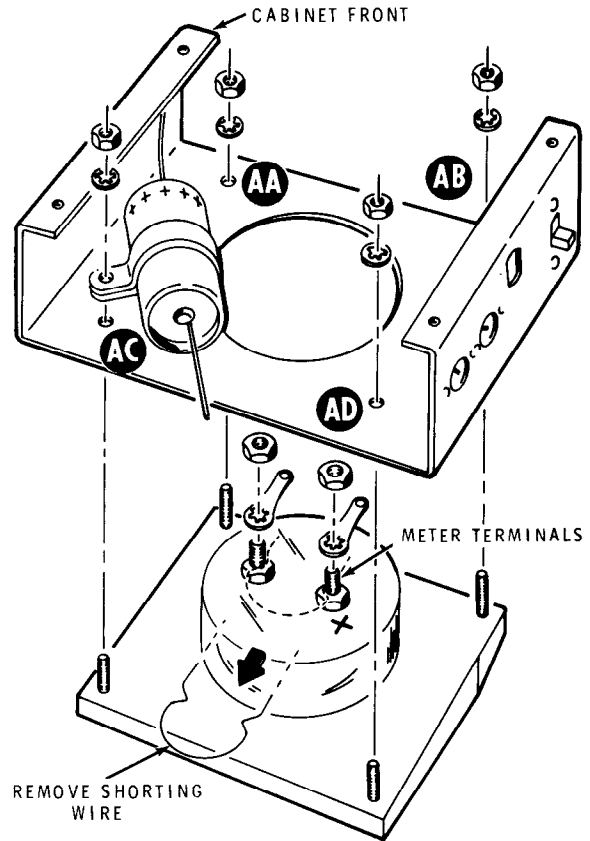

**PICTORIAL 2**

- ( ) Mount the 70 μF capacitor with the cable clamp at AC with a lockwasher and nut. Do not tighten the nut.
- ( ) With the capacitor positioned as shown, tighten the four nuts. Do not overtighten these nuts, as the plastic meter case may be cracked.
- ( ) Remove the shorting wire from the meter and discard the shorting wire.
- ( ) Remove the outer nut and solder lug from each of the meter terminals.

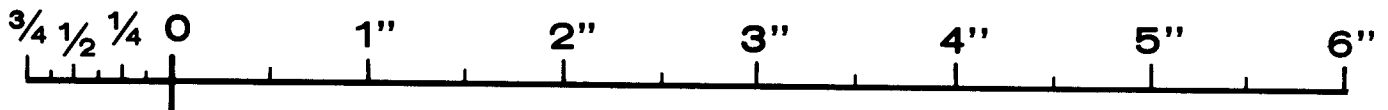

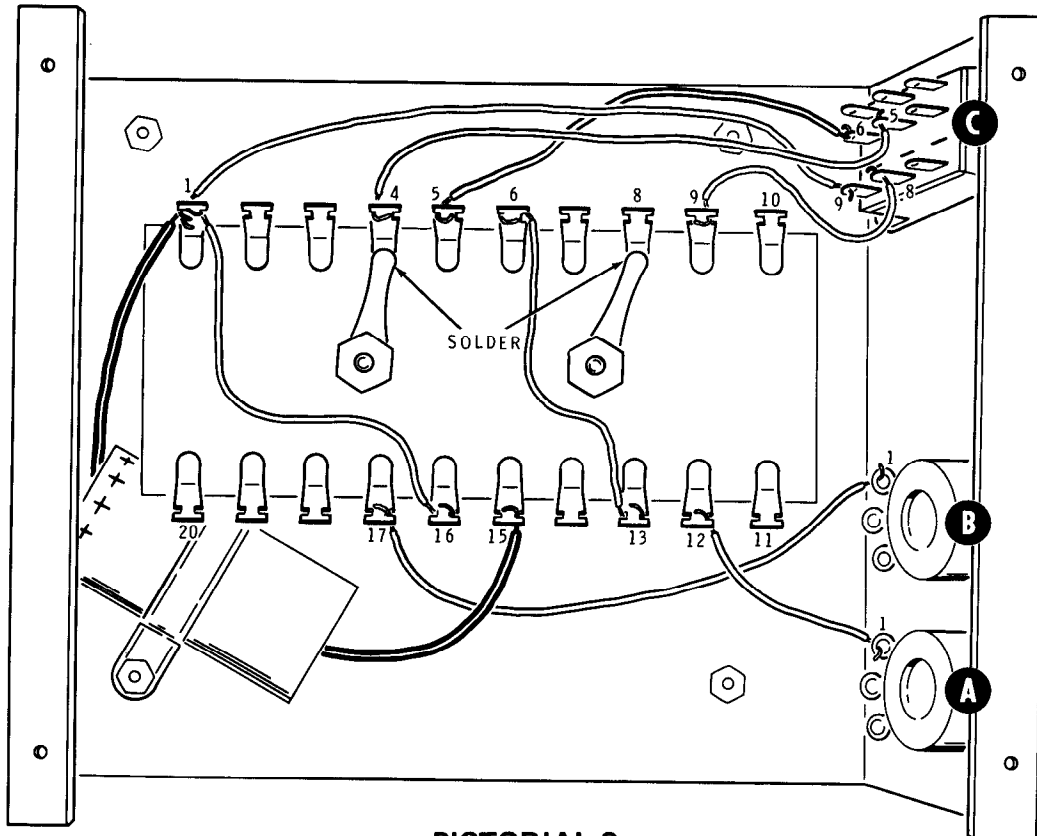

PICTORIAL 3

Refer to Pictorial 3 for the following steps.

- ( ) Mount the 20-lug terminal strip on the meter terminals. Position the solder lugs as shown and tighten the nuts carefully.

**CAUTION:** When making solder connections near the meter, do not allow the iron to come in contact with the meter case.

- ( ) Solder the meter solder lugs as shown to lugs 4 and 8 of the terminal strip.
- ( ) Place a 2" length of sleeving over the positive (+) lead of the 70  $\mu$ F capacitor.
- ( ) Connect this lead to lug 1 of the terminal strip (NS).

**NOTE:** In the following steps position all wires against the front panel and crimp the wire ends to the lugs on the terminal strip.

- ( ) Connect the free end of the wire coming from lug 9 of slide switch C to lug 1 of the terminal strip (NS).

- ( ) Prepare a 4" gray wire and connect it between lug 1 (NS) and lug 16 (NS) of the terminal strip.
- ( ) Prepare a 2-3/4" gray wire and connect it between lug 6 (NS) and lug 13 (NS) of the terminal strip.
- ( ) Connect the wire coming from lug 6 of slide switch C to lug 5 of the terminal strip (NS).
- ( ) Connect the wire coming from lug 8 of slide switch C to lug 9 of the terminal strip (NS).
- ( ) Connect the wire coming from lug 5 of the slide switch C to lug 4 of the terminal strip (S-1).
- ( ) Connect the wire coming from lug 1 of control B to lug 17 of the terminal strip (NS).
- ( ) Place a 2-1/2" length of sleeving over the negative (-) lead of the 70  $\mu$ F capacitor. Connect this lead to lug 15 of the terminal strip (NS).
- ( ) Connect the wire coming from lug 1 of control A to lug 12 of the terminal strip (NS).



# PARTS PICTORIAL

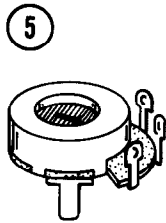
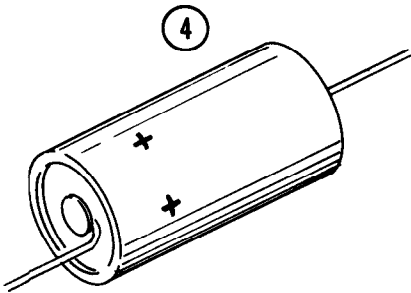
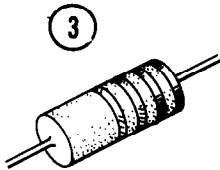
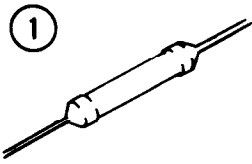

6

7

8

NOTE: HEATH PART NUMBERS ARE STAMPED ON MOST DIODES.

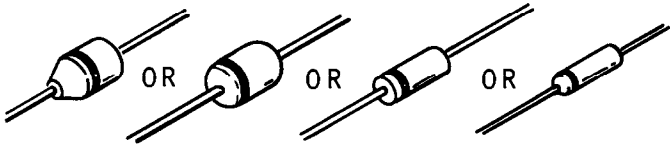

9



10

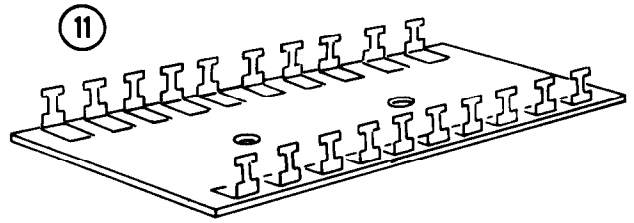

12



13

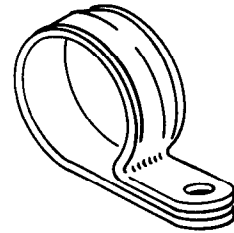

14

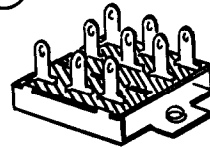

15

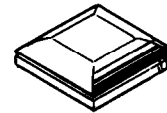

16

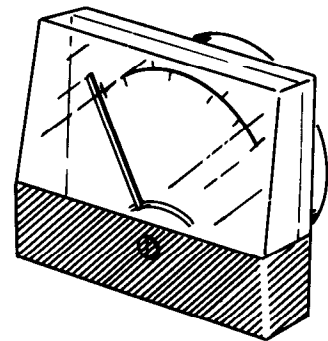

17

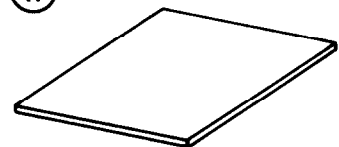

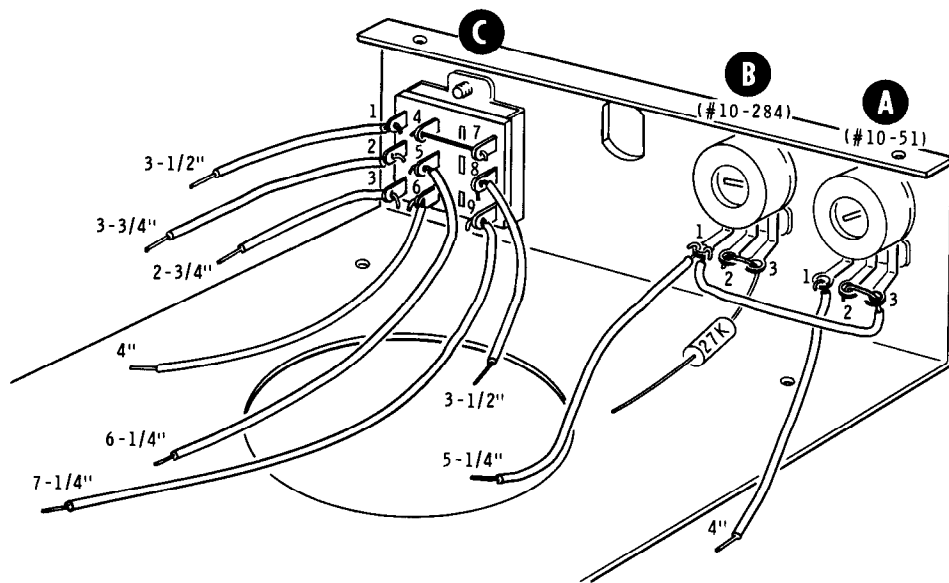

**PICTORIAL 1**

Refer to Pictorial 4 for the following steps.

- ( ) Connect the wire coming from lug 3 of slide switch C to lug 10 of the terminal strip (NS).
- ( ) Connect the wire from lug 2 of slide switch C to lug 8 of the terminal strip (S-1).
- ( ) Connect the wire coming from lug 1 of slide switch C to lug 7 of the terminal strip (NS).
- ( ) Connect one lead of a 100  $\Omega$  (brown-black-brown) 2-watt resistor to lug 1 (S-4) and the other lead to lug 20 (NS) of the terminal strip.

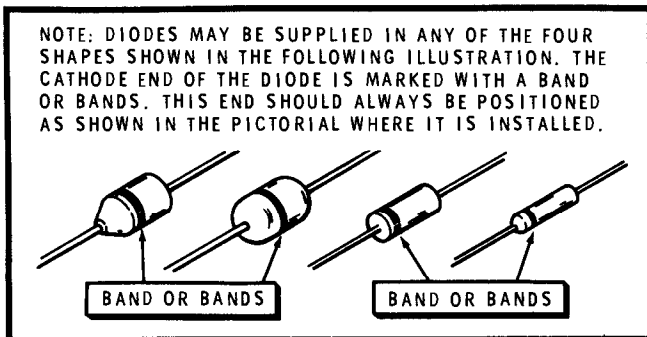

**Detail 4A**

- ( ) Refer to Detail 4A. Then route the lead from the cathode (banded) end of a 1N2071 silicon diode (#57-27) around lug 19 (S-2) to lug 20 (S-2) of the terminal strip.
- ( ) Route the lead from the other end of this diode to lug 2 of the terminal strip (NS).

- ( ) Connect a 10 k $\Omega$  (brown-black-orange) 2 watt resistor between lug 5 (NS) and lug 16 (S-2) of the terminal strip.
- ( ) Connect a 3600  $\Omega$  (3.6k) precision resistor from lug 15 (NS) to lug 17 (S-2) of the terminal strip.
- ( ) Cut two 1/2" lengths of small sleeving. Place one of these lengths on each lead of the zener diode (#56-36).
- ( ) Route the lead from the cathode (banded) end of this diode around lug 6 (S-3) to lug 5 (S-3) of the terminal strip.
- ( ) Connect the other lead of this diode to lug 15 of the terminal strip (NS).
- ( ) Route the lead from one end of a 4500  $\Omega$  (4.5k) precision resistor around lug 14 (NS) to lug 15 (S-4) of the terminal strip.
- ( ) Connect the lead from the other end of this resistor to lug 7 of the terminal strip (NS).
- ( ) Connect a 9000  $\Omega$  (9k) resistor between lug 7 (S-3) and lug 13 (S-2) of the terminal strip.
- ( ) Connect an 18 k $\Omega$  precision 1 watt resistor between lug 9 (S-2) and lug 12 (S-2) of the terminal strip.
- ( ) Connect the lead from the cathode (banded) end of a 1N4149 silicon diode (#56-56) to lug 10 (S-2) and the other lead to lug 11 (NS) of the terminal strip.
- ( ) Connect the free lead of the 27 k $\Omega$  resistor coming from lug 3 of control B to lug 11 of the terminal strip (S-2).

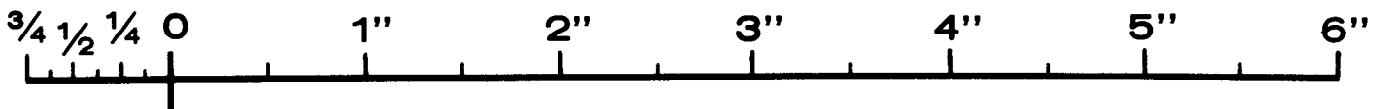

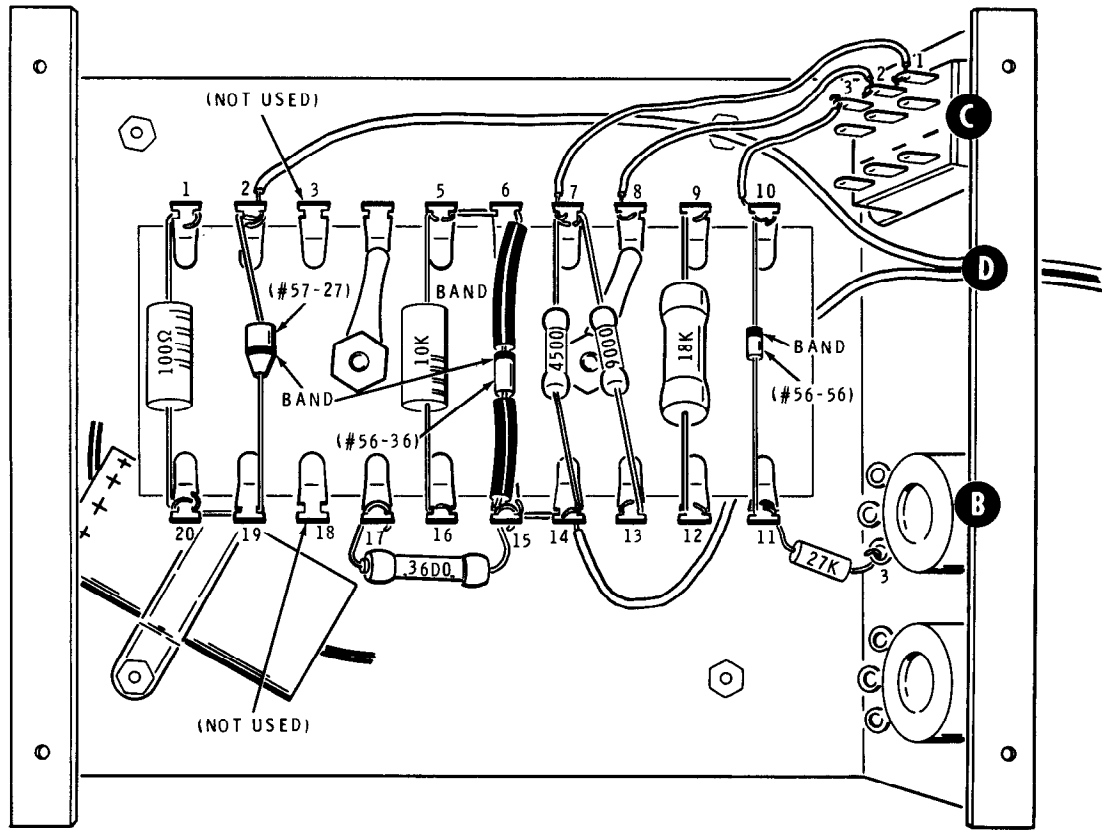

**PICTORIAL 4**



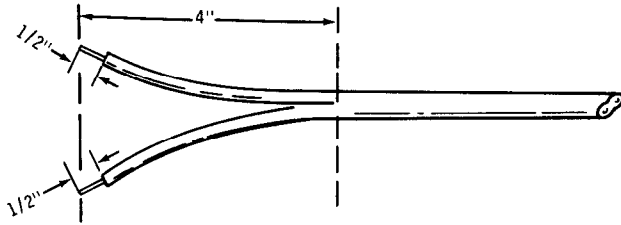

Detail 4B

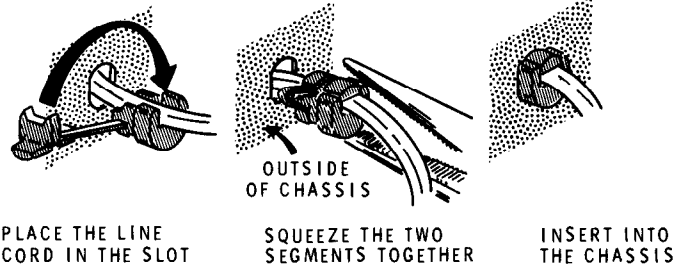

Detail 4C

- ( ) Refer to Detail 4B and separate the line cord wires as shown. Then twist the small wire strands together and apply a small amount of solder to the end of each wire to hold the separate strands together.
- ( ) Pass this end of the line cord through hole D of the cabinet front. Then connect one line cord wire to lug 2 (S-2) and the other line cord wire to lug 14 (S-3) of the terminal strip.

- ( ) Refer to Detail 4C and install a strain relief on the line cord and in hole D as shown.

This completes the initial wiring of the chassis. Carefully inspect the unit for loose wires or unsoldered connections. Remove any wire clippings or solder splashes that may be lodged in the wiring. Then proceed to the "Initial Test" section.

## INITIAL TEST

**NOTE:** The purpose of the "Initial Test" section of the Manual is to make sure your Line Voltage Monitor will not be damaged as the result of a wiring error or some other difficulty when it is first turned on. If you do not have an ohmmeter, disregard the following "Resistance Check" and proceed to the "Final Assembly" section.

### RESISTANCE CHECK

- ( ) Place the NORM-CAL switch in the CAL position.
- ( ) Set the ohmmeter to the 10 k $\Omega$  range.

- ( ) Connect the negative, or common, ohmmeter lead to lug 15 of the terminal strip.
- ( ) Connect the other ohmmeter lead to lug 19 of the terminal strip. After the meter stops moving, a reading of at least 20 k $\Omega$  should be obtained. If the reading is less than 20 k $\Omega$ , recheck the wiring and refer to the "In Case of Difficulty" section. Resolve any difficulty and recheck to obtain the proper ohmmeter reading before proceeding to the "Final Assembly."

## FINAL ASSEMBLY

Refer to Pictorial 5 for the following steps.

**NOTE:** In the following step you will be instructed to mount the plastic feet. These feet may be installed either on the bottom or back of the cabinet.

- ( ) Remove the backing from the plastic feet. Press these feet into the desired position as shown.

**NOTE:** The heavy insulation paper installed in the next steps protects the Line Voltage Monitor against any metal objects which might enter the cabinet back through the wall-mount opening.

- ( ) Position the insulation paper with the wax paper backing up, as shown in the inset drawing. Measure 1-1/4" from the edge and mark the paper backing.

**NOTE:** In the following step you will be instructed to cut through the wax paper backing. **DO NOT** cut through the heavy insulation paper.

- ( ) With a knife, cut through the wax paper backing along the line you marked in the last step.
- ( ) Remove the 1-1/4" piece of wax paper backing. Then turn the insulation paper over and press it into position, as shown, with its edge against the inner corner of the cabinet.

**NOTE:** The blue and white label which will be installed in the following step shows the model number and the

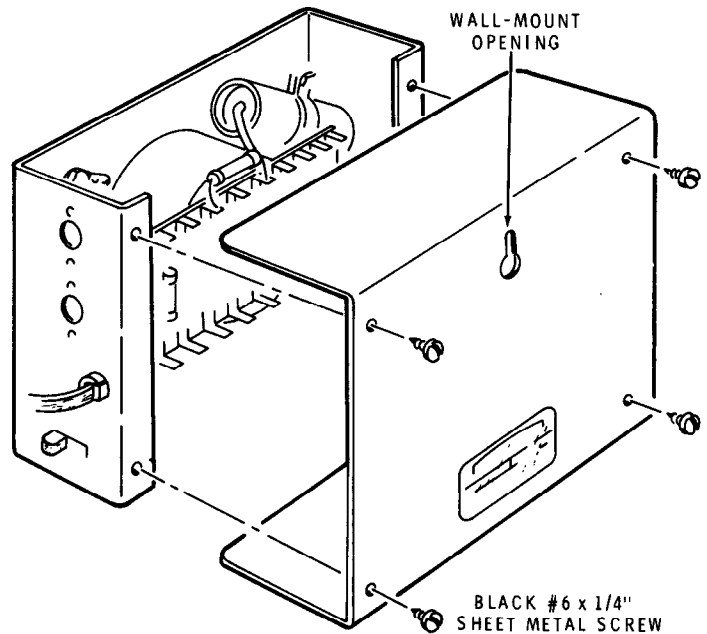

**Detail 5A**

production series number of your kit. Refer to these numbers in any communications with the Heath Company about this kit.

- ( ) Carefully remove the paper backing from the blue and white label and press it into position as shown.
- ( ) Refer to Detail 5A and attach the cabinet back to the cabinet front with black #6 x 1/4" sheet metal screws. Note the position of the wall-mounting opening.

This completes the assembly of your Heathkit Model IM-103 Line Voltage Monitor.

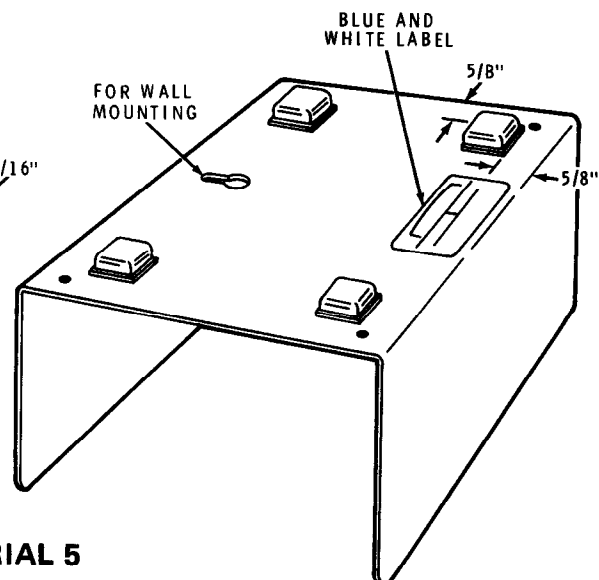
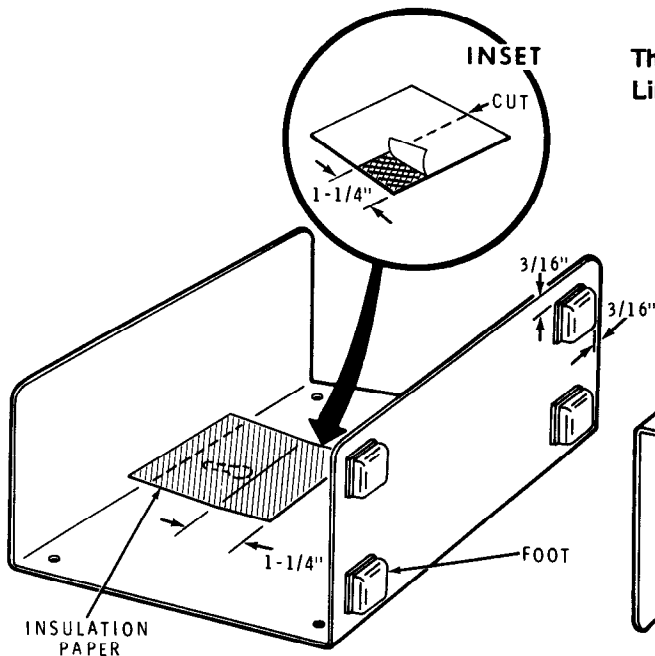

**PICTORIAL 5**

## ADJUSTMENTS

These instructions are divided into two sections. Use the first section "Adjustment Without Instruments," when additional test equipment is not available. Use the second section, "Adjustments With Instruments," to obtain greater accuracy when an accurate AC voltmeter and a variable AC voltage source are available.

### ADJUSTMENTS WITHOUT INSTRUMENTS

- ( ) Set the HI and LOW controls at the center of their rotation.
- ( ) Before connecting the Line Voltage Monitor to an AC outlet, check to see that the meter indicates at the 90 volt point on the scale. If necessary, adjust the screw on the front of the meter so the meter needle is on 90.
- ( ) Place the NORM-CAL switch in the CAL position.
- ( ) Connect the Line Voltage Monitor to an AC outlet.
- ( ) Adjust the LOW control to indicate 137.5 V on the meter.
- ( ) Return the NORM-CAL switch to NORM.

NOTE: To complete the following step, it is necessary to know the correct power line voltage. If you do not know the correct power line voltage, do not perform this step.

- ( ) Adjust the HI control to indicate the voltage of the line being measured.

This completes the adjustment of the Line Voltage Monitor.

### ADJUSTMENTS WITH INSTRUMENTS

- ( ) Set the HI and LOW controls at the center of their rotation.
- ( ) Before connecting the Line Voltage Monitor to an AC outlet, check to see that the meter indicates at the 90 volt point on the scale. If necessary, adjust the screw on the front of the meter so the meter needle is on 90.

NOTE: A variable AC voltage source and an accurately calibrated AC voltmeter are required for the following steps.

- ( ) Place the NORM-CAL switch in the NORM position.
- ( ) Set the output from the variable supply to 95 VAC as indicated on the power supply meter.
- ( ) Adjust the LOW control for a meter reading of 95 VAC on the Line Voltage Monitor.
- ( ) Set the output from the variable supply to 135 VAC.
- ( ) Adjust the HI control for a meter reading of 135 VAC on the Line Voltage Monitor.
- ( ) Repeat the above steps until the Line Voltage Monitor reads the same as the meter on the variable supply at 95 VAC and 135 VAC.

This completes the adjustments of the Line Voltage Monitor.

## IN CASE OF DIFFICULTY

This part of the Manual will help you locate and correct any difficulty which might occur in your Monitor.

1. Recheck the wiring. Trace each lead in colored pencil on the Pictorial as it is checked. It is frequently helpful to have a friend check your work. Someone who is not familiar with the unit may notice something consistently overlooked by the kit builder.

2. About 90% of the kits that are returned to the Heath Company for repair do not function properly due to poor connections and soldering. Therefore, many troubles can be eliminated by reheating all connections to make sure that they are soldered as described in the Soldering section of the Kit Builders Guide.





3. Check the values of the parts. Be sure in each step that the proper part has been wired into the circuit, as shown in the Pictorial diagrams.
4. Check for bits of solder, wire ends, or other foreign matter which may be lodged in the wiring.

5. A review of the Circuit Description may also help you determine where the trouble is.

NOTE: In an extreme case where you are unable to resolve a difficulty, refer to the "Service and Warranty" sections of the "Kit Builders Guide," and to the "Factory Repair Service" information on Page 15 of this Manual.

### Troubleshooting Chart

PROBLEM	POSSIBLE CAUSE
"Initial Test" ohmmeter reading is below 20 kΩ.	<ol style="list-style-type: none"> <li>1. Check wiring to switch.</li> <li>2. Zener diode D3 installed incorrectly.</li> </ol>
No meter indication.	<ol style="list-style-type: none"> <li>1. Improper power source (source voltage must be between 90 and 140 VAC).</li> <li>2. Diode D1 or D2 installed backward or faulty.</li> </ol>
Meter deflects below 90 at the left side of meter scale.	<ol style="list-style-type: none"> <li>1. Reversed connections to meter.</li> <li>2. Diode D2 installed backward.</li> </ol>
Meter deflects maximum to the right side of meter scale.	<ol style="list-style-type: none"> <li>1. HI adjustment incorrect.</li> <li>2. Zener diode (D3) installed incorrectly or faulty.</li> </ol>
137.5 V measurement cannot be obtained in CAL position of slide switch.	<ol style="list-style-type: none"> <li>1. Incorrect wiring to slide switch and to controls R3 and R6.</li> </ol>

## SPECIFICATIONS

Voltage Range . . . . .	90 VAC (rms) to 140 VAC (rms).
Voltage Accuracy (Sine Wave) . . . . .	±2% when calibrated at 95 VAC and 135 VAC from an accurate voltage source. ±5% when calibrated with a known line voltage.
Power Requirements . . . . .	90 VAC (rms) to 140 VAC (rms), 50 to 60 Hz, 4.2 watts.
Dimensions . . . . .	5-1/8" high x 6-1/4" wide x 3" deep.
Net Weight . . . . .	2 lbs.

---

The Heath Company reserves the right to discontinue products and to change specifications at any time without incurring any obligation to incorporate new features in products previously sold.

## CIRCUIT DESCRIPTION

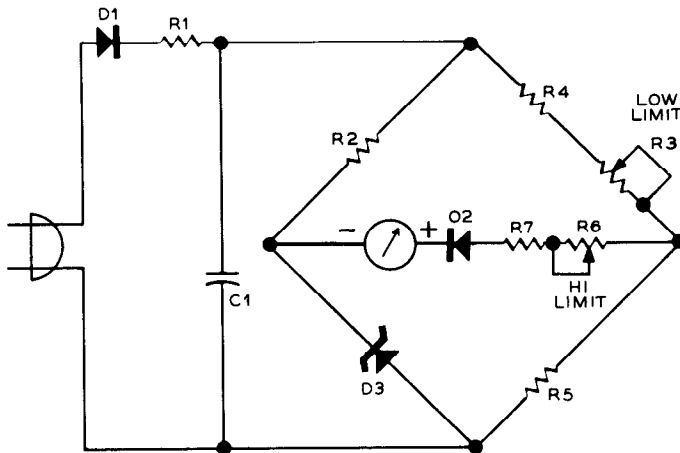

Figure 1

Refer to the Schematic Diagram while you read this Circuit Description.

The line voltage being monitored is rectified and filtered by diode D1, resistor R1 and capacitor C1 to produce a DC voltage. This DC voltage is then applied to a bridge circuit, which is shown redrawn in Figure 1 without the NORM-CAL switch (switch in the Norm position).

Zener diode D3 holds the negative side of the meter at a constant potential. The Low Limit control (R3) is adjusted so the bridge is balanced (no current through the meter) with a 90 VAC line voltage input. When the line voltage input increases, the voltage at the junction of R3 and R5 increases proportionally. Current then flows through the meter, deflecting the meter above 90 on the scale.

Hi Limit control R6 is adjusted so the meter will deflect to full scale with an input line voltage of 140 VAC. Diode D2 is in series with the meter to protect it from the reverse current produced when the input line voltage drops below 90 VAC.

Figure 2 is a simplified drawing of the circuit when the NORM-CAL switch is placed in the CAL position (used only when the Monitor is adjusted without a voltage standard. See "Adjustments Without Instruments," Page 9). R8 and R9 form a voltage divider across zener diode D3. The zener-regulated voltage across R9 is then used as a calibration source for the meter, which is in series with the Low Limit control, R4, and R5. The Low Limit control is adjusted to produce a predetermined current through the meter (at the 137.5 VAC rms point). This setting of R3 will produce a voltage at the junction of R3 and R5 that causes a meter reading of (approximately) the actual line voltage when the switch is placed in NORM position and the Hi Limit control (R6) is set at the center of its rotation.

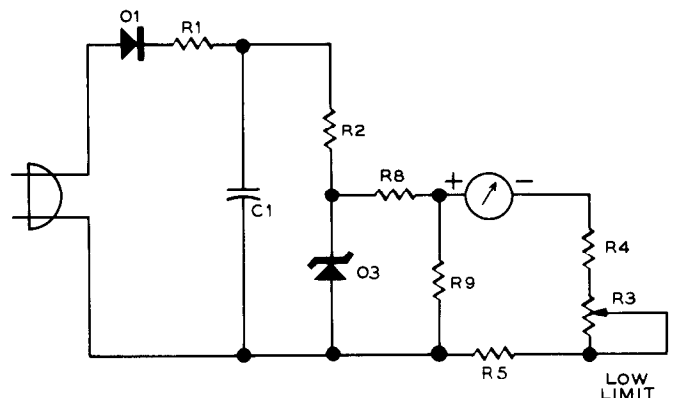

Figure 2



## REPLACEMENT PARTS PRICE LIST

The following prices apply only on purchases from the Heath Company where shipment is to a U.S.A. destination. Add 10% (minimum 25 cents) to the price when ordering from an authorized Service Center or Heathkit Electronic Center to cover local sales tax, postage and handling. Outside the U.S.A. parts and service are available from your

local Heathkit source and will reflect additional transportation, taxes, duties and rates of exchange.

To order parts, use the Parts Order Form furnished with this kit. If a Parts Order Form is not available, refer to Replacement Parts in the Kit Builders Guide.

PART No.	PRICE Each	DESCRIPTION
----------	------------	-------------

### RESISTORS

#### 1% Precision, 1/2 Watt

2-121	.25	3600 $\Omega$ (3.6k)
2-35	.20	9000 $\Omega$ (9k)
2-176	.20	4500 $\Omega$ (4.5k)

#### Other Resistors

2-94-1	.20	18 k $\Omega$ precision, 1 watt
1-23	.10	27 k $\Omega$ , 1/2 watt
1-20-2	.15	100 $\Omega$ , 2 watt
1-3-2	.15	10 k $\Omega$ , 2 watt

### CAPACITOR-CONTROLS

25-43	1.15	70 $\mu$ F electrolytic capacitor
10-51	.35	5000 $\Omega$ control (5k)
10-284	.35	20 k $\Omega$ contro'

### DIODES

56-36	1.50	Zener diode
56-56	.20	1N4149 silicon diode
57-27	.50	1N2071 silicon diode

PART No.	PRICE Each	DESCRIPTION
----------	------------	-------------

### HARDWARE

250-116	.05	6-32 x 1/4" black screw
250-369	.05	#6 x 1/4" black sheet metal screw

### TERMINAL STRIP

431-87	.45	20-lug terminal strip
--------	-----	-----------------------

### METAL PARTS

90-484	1.35	Cabinet front
90-485	1.25	Cabinet back

### WIRE-SLEEVING

344-58	.05/ft	Gray wire
89-1	.45	Line cord
346-1	.05/ft	Smell sleeving

### MISCELLANEOUS

75-24	.10	Strain relief
207-72	.10	Cable clamp
60-20	.30	Slide switch
261-29	.05	Plastic foot
407-156	8.50	Meter
75-90	.10	Insulation paper
331-6	.15	Solder
	2.00	Manual (See front cover for part number.)

## FACTORY REPAIR SERVICE

You can return your completed kit to the Heath Company Service Department to have it repaired for a minimum service fee. (Kits that have been modified will not be accepted for repair.) If you wish, you can deliver your kit to a nearby Heath Authorized Service Center. These centers are listed in your Heathkit catalog.

To be eligible for replacement parts under the terms of the warranty, equipment returned for factory repair service, or delivered to a Heath Authorized Service Center, must be accompanied by the invoice or the sales slip, or a copy of either. If you send the original invoice or sales slip, it will be returned to you.

If it is not convenient to deliver your kit to a Heath Authorized Service Center, please ship it to the factory at Benton Harbor, Michigan and follow the following shipping instructions:

Prepare a letter in duplicate, containing the following information:

- Your name and return address.
- Date of purchase.
- A brief description of the difficulty.
- The invoice or sales slip, or a copy of either.
- Your authorization to ship the repaired unit back to you C.O.D. for the service and shipping charges, plus the cost of parts not covered by the warranty.

Attach the envelope containing one copy of this letter directly to the unit before packaging, so that we do not overlook this important information. Send the second copy of the letter by separate mail to Heath Company, Attention: Service Department, Benton Harbor, Michigan.

Check the equipment to see that all parts and screws are in place. (Do not include wooden cabinets when shipping receivers, tuners, amplifiers, or TV sets, as these are easily damaged in shipment.) Then, wrap the equipment in heavy paper. Place the equipment in a strong carton, and put at least THREE INCHES of resilient packing material (shredded paper, excelsior, etc.) on all sides, between the equipment and the carton. Seal the carton with gummed paper tape, and tie it with a strong cord. Ship it by prepaid express, United Parcel Service, or insured parcel post to:

Heath Company  
Service Department  
Benton Harbor, Michigan 49022

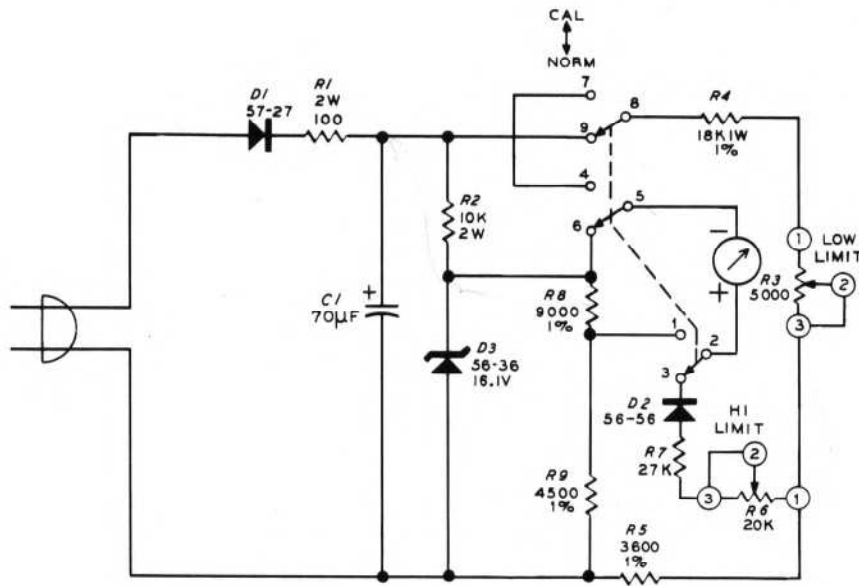

NOTES:

1. All resistor values are in ohms; K = 1000.
2. All resistors are 1/2 watt unless marked otherwise.

SCHMATIC DIAGRAM

CHASSIS PHOTOGRAPH

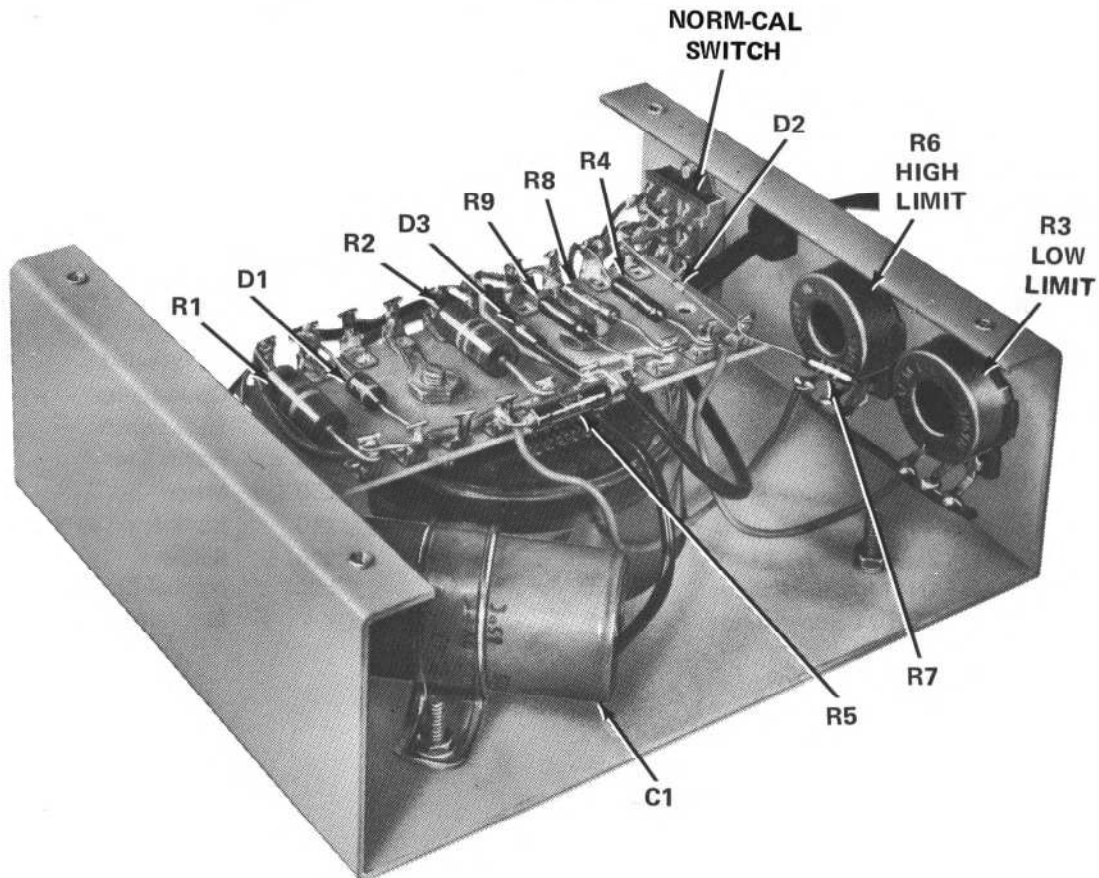

# HEATH COMPANY

BENTON HARBOR, MICHIGAN

**THE WORLD'S FINEST ELECTRONIC EQUIPMENT IN KIT FORM**

LITHO IN U.S.A.