

HEATHKIT[®] MANUAL

for the

VHF DUAL WATTMETER

Model HM-2141

595-2203-01

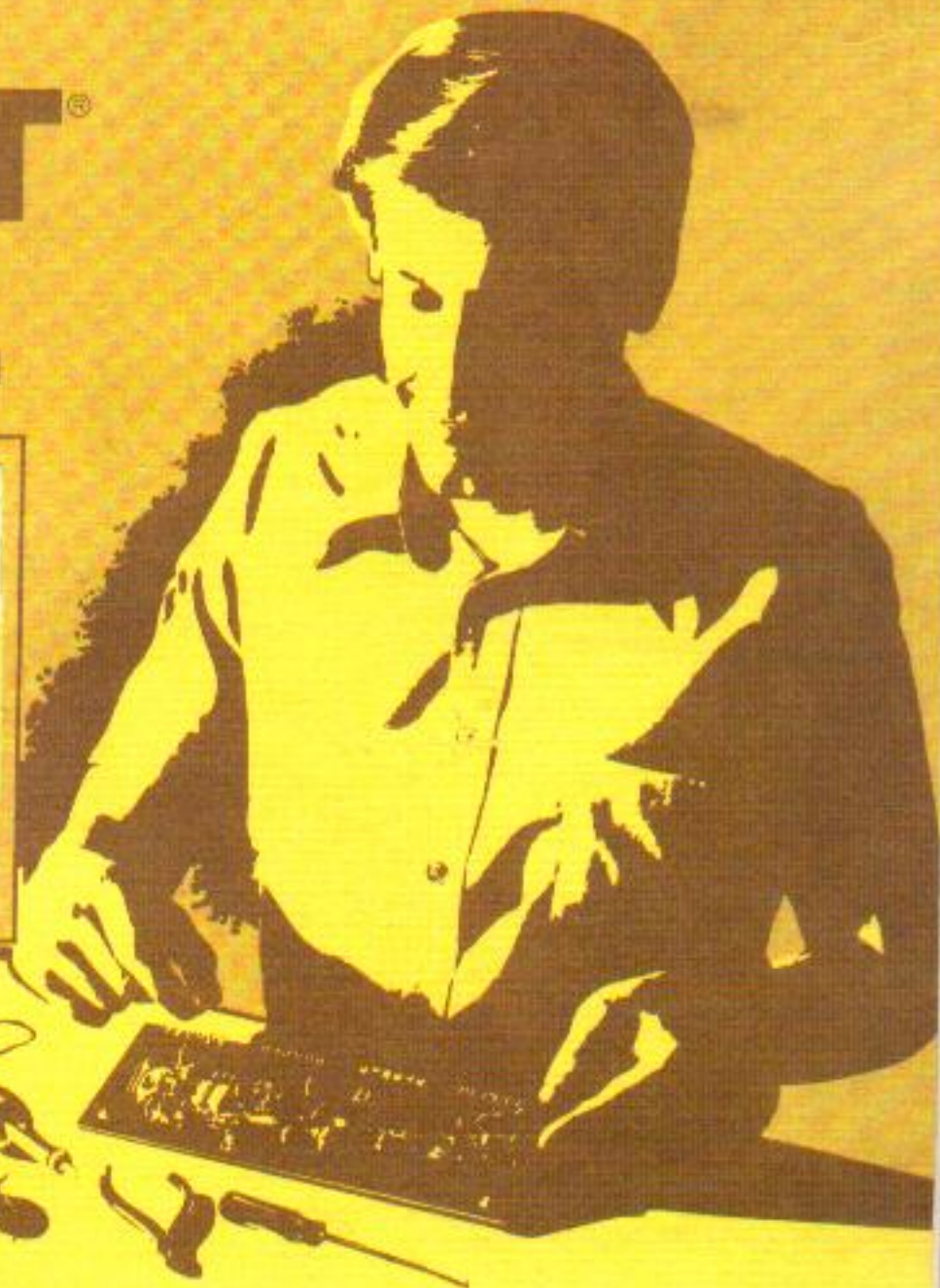
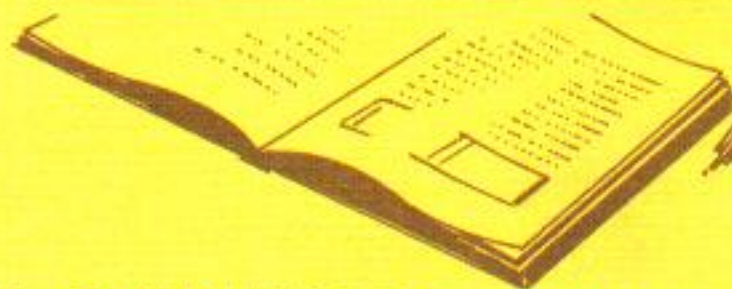

HEATH COMPANY • BENTON HARBOR, MICHIGAN

REMOTE SENSOR

(100-1741)

SENSOR CIRCUIT BOARD

(85-2236-1)

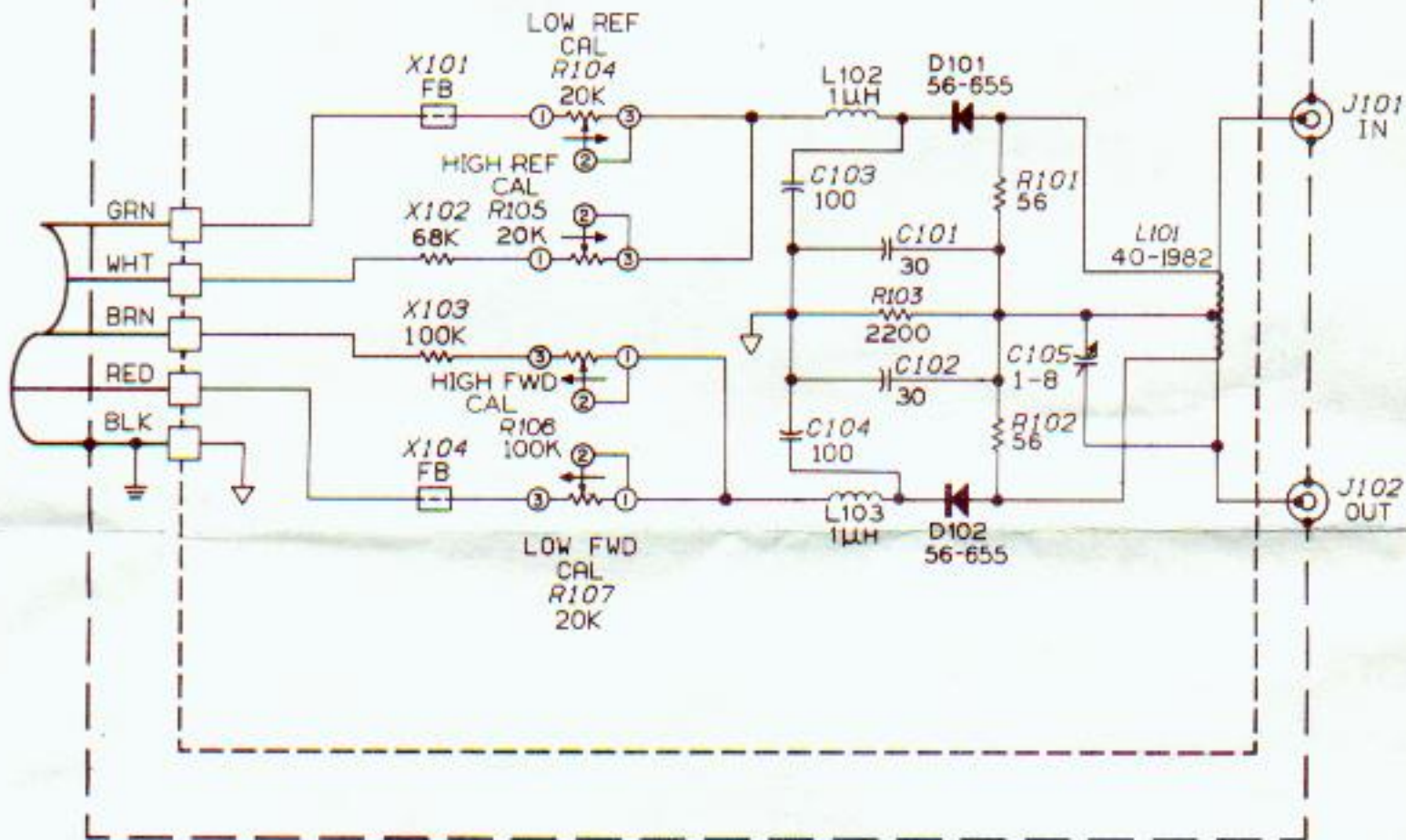

595-2203-01

Copyright © 1979

Heath Company

All Rights Reserved

Printed in the United States of America

SENSITIVITY control (and Battery Switch) — When you wish to check the condition of the Wattmeter battery (if used - see "Wattmeter Power" in the following text), turn the SENSITIVITY control fully counterclockwise until it clicks, and set the PEP-AVG switch to AVG (out). Then make sure the FWD meter pointer comes to rest inside the "BATT" scale on the meter. If it does not, replace the battery before you use the Wattmeter. The control function is used when you "Set" the meter to read SWR (see "SWR Measurements").

REF meter — This is a direct readout meter that indicates either the power reflected back through the transmission line in watts or indicates the standing wave ratio on the transmission line. A "Set" index is used in conjunction with SWR measurements.

FWD meter — This meter indicates the direct power output (in watts) of your equipment at the point in the transmission line where you have installed the Wattmeter. The meter has two power scales — high and low — and a third scale labeled "BATT" so you may observe the condition of the battery at any time.

Special Note

Many transceivers do not provide the same output power in the CW mode when the peak power and the average power readings are taken. A typical waveform is shown in Pictorial 5-3.

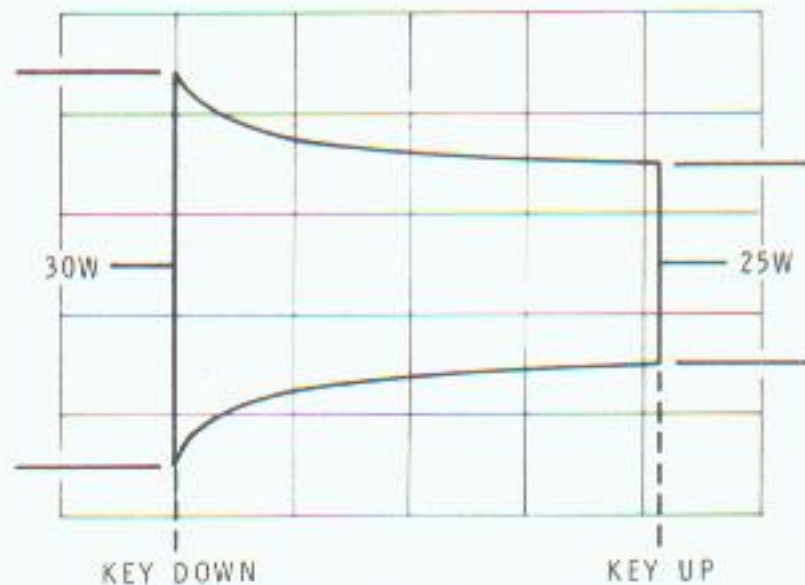

PICTORIAL 5-3

This drop is usually attributed to inherent conditions in some power supplies, especially those in self-contained transceivers, that is, with all power being internal to the unit. This is a normal condition; neither the transceiver nor the Wattmeter are malfunctioning.

SWR MEASUREMENTS

To make standing wave ratio measurements:

- A. Push the SWR-REF pushbutton to SWR (in).
- B. Push the SET-FWD pushbutton to SET (in).
- C. Transmit a CW signal. Turn the SENSITIVITY control and position the REF meter pointer to the "SET" index.
- D. Push the SET-FWD pushbutton to FWD (out).
- E. Read the standing wave ratio (SWR) on the REF meter.

If you wish to calculate an exact VSWR, refer to the "SWR Calculator" shown in Pictorial 5-4 (Illustration Booklet, Page 12). Follow the instructions on the scale and read the SWR directly from the center scale.

WATTMETER POWER

You may use either of two power sources in the Wattmeter, or you may use both. We recommend an **alkaline** power cell, NEDA Type #1604 for battery power, and you may purchase the optional 9-volt Heathkit Converter Model GRA-43-1 if you want to power the Wattmeter without a battery or if you wish to use both.

When you use the Wattmeter away from conventional AC power sources, you will need the battery for PEP operation. The battery is easy to install into the battery holder on the switch circuit board; merely loosen the four side-trim screws, lift the top cover from the Wattmeter, then plug in the battery and push the battery down into the battery holder. Replace the cabinet top cover and tighten the trim screws.

When you are close to a conventional source of 120-volt AC power, and if you have the Converter, merely plug it into a wall outlet and push the small plug into switch circuit board jack J1. NOTE: In the VHF Dual Wattmeter, the Converter is used as a **Battery Eliminator**; it will **not** charge your battery, which is disconnected from the Wattmeter circuits when the Converter is connected to J1.

IN CASE OF DIFFICULTY

This section of the Manual is divided into two parts. The first part, titled "General," describes what to do about any difficulties that might occur right after the unit is assembled. The second part, titled "Troubleshooting Chart" lists a number of possible difficulties that could arise. It also lists the possible causes of these difficulties.

GENERAL

The following paragraphs deal with the types of difficulties that may show up right after the kit is assembled, before you can put it into operation. These difficulties are most likely to be caused by assembly errors or faulty soldering. The following checks will help you locate any error of this type.

NOTE: Refer to the "Circuit Board X-Ray Views" (Illustration Booklet, Pages 13 and 14) for the physical location of parts.

1. It is frequently helpful to have a friend check your work. Someone who is not familiar with the unit may notice something you consistently overlook.
2. About 90% of the kits that are returned for repair do not function properly due to poor connections and soldering. Therefore you can eliminate many troubles by reheating all connections to make sure

that they are soldered as described in the "Soldering" section parts. Be sure the proper part has been wired into the circuit at each location as shown in the Pictorials and as called out in the wiring instructions.

3. Check the values of the parts. Be sure the proper part has been wired into the circuit at each location as shown in the Pictorials and as called out in the wiring instructions.
4. Check for bits of solder, wire ends, or other foreign matter which may be lodged in the wiring or between the foils on the circuit board.
5. If, after careful checks, you still cannot locate the trouble and a voltmeter is available, check voltage readings against those shown on the Schematic Diagram. **NOTE:** All voltage readings were taken with a high input impedance voltmeter. Voltages may vary as much as $\pm 20\%$.
6. A review of the "Circuit Description" may also help you find the trouble.

NOTE: In an extreme case where you are unable to resolve a difficulty, refer to the "Customer Service" information inside the rear cover of the Manual. Your Warranty is located inside the front cover.

Troubleshooting Chart

The following chart lists conditions and possible causes of several specific malfunctions. If a particular part is mentioned (R23 for example) as a possible cause, check that part and other components connected to that part to see that they are installed and/or wired correctly. Also check for solder bridges and poor connections in the surrounding area. It is also possible, on rare occasions, for a part to be faulty and require replacement.

PROBLEM	POSSIBLE CAUSE
Meters inoperative, PEP-AVG switch in AVG position.	<ol style="list-style-type: none"> 1. Shorting wire still on meters. 2. Sensitivity control wiring. 3. No RF through remote sensor. 4. Sensor cable connections on the circuit board.
Meters inoperative, PEP-AVG switch in PEP position.	<ol style="list-style-type: none"> 1. Battery dead. 2. Integrated circuit U1. 3. Solder bridge on circuit board foil.
Battery check produces no meter movement.	<ol style="list-style-type: none"> 1. Battery dead. 2. Resistor R6. 3. Battery switch SW5. 4. PEP-AVG switch not set to AVG (out).
Unable to calibrate PEP circuit.	<ol style="list-style-type: none"> 1. Solder bridge on circuit board foil. 2. Battery weak or dead. 3. Check PEP circuit components for correct installation.

SPECIFICATIONS

Frequency Range	50 to 175 MHz.
Functions	Forward and reflected power (AVG and PEP), and SWR.
Meter Ranges	
Forward (2 scales)	Low, 0-30 watts PEP. High, 0-300 watts PEP.
Reverse (3 scales)	Low, 0-10 watts PEP. High, 0-100 watts PEP. SWR, 1:1 to 3:1
Insertion SWR	Less than 1.05:1.
Accuracy (full scale)	
30 W and 300 W (FWD), 100 W (REF)	$\pm 7.5\%$ (AVG).
10 W (REF)	$\pm 10\%$ (AVG).
Power	9-volts DC (Battery NEDA Type #1604, or optional Heathkit Converter).

TESTS AND ADJUSTMENTS

Refer to Pictorials 3-1 and 3-2 (Illustration Booklet, Page 8) for the following steps.

INITIAL TESTS AND ADJUSTMENTS

- (✓) Refer to Pictorial 3-1 and, on the front panel of your Wattmeter, turn the SENSITIVITY control fully counterclockwise until it clicks.
- (✓) Press the four pushbutton switches once or twice to be sure they are all in the "out" position.
- (✓) Set each of the circuit board controls to the mid-point of their rotation.
- (✓) Check the REF and FWD meters to make sure each meter pointer is exactly over the meter scale zero ("0"). If either one is not, adjust the zero-adjust screw on the front of the meter until the pointer is exactly at the "0" mark.
- () Push the PEP-AVG switch in. Check the FWD meter to see that the pointer comes to rest in the segment labeled "BATT."
- () Turn the SENSITIVITY control fully clockwise. Make sure the PEP-AVG switch is in – at the PEP position.

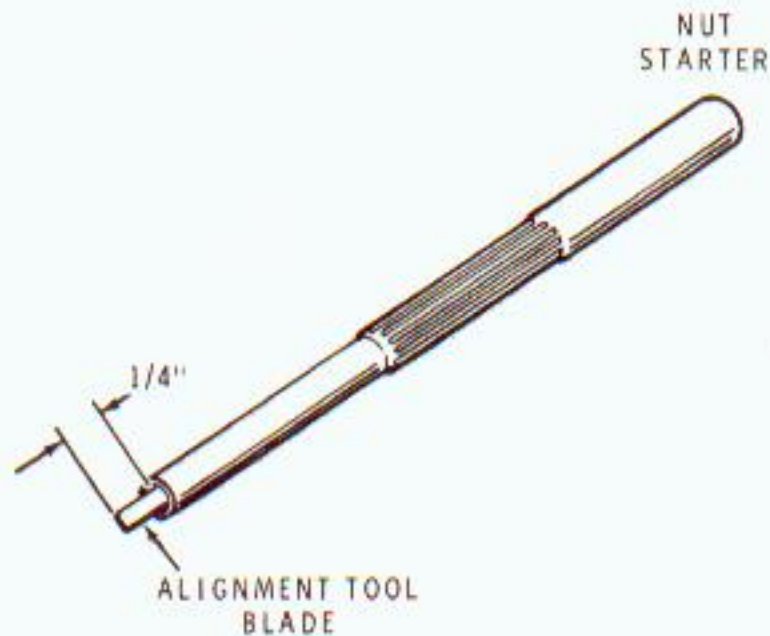

Detail 3-2A

- () Refer to Detail 3-2A and push the thin alignment tool blade into the small end of the nut starter as shown. This is the tool you will use to adjust the circuit board controls in the following steps.
- () As you observe the REF meter, turn REF NULL control R13 (on the circuit board) in either direction to exactly zero the pointer.

- () As you observe the FWD meter, turn FWD NULL control R14 (on the circuit board) in either direction to exactly zero the pointer.
- () Push the PEP-AVG switch to its AVG (out) position.

ADJUSTMENTS

NOTE: In the following steps that call for adjustments using transmitter power, your transmitter should ideally put out a CW or unmodulated FM level of at least 10-watts.

- () Refer to Pictorial 3-3 and connect the output of your transmitter to the IN coaxial jack on the remote sensor and a 50-ohm dummy load to the OUT coaxial jack on the sensor as shown. NOTE: You may also use an antenna in place of the dummy load, but remember to properly identify your station because you will be radiating a signal.
- () Tune the transmitter for a CW or unmodulated FM signal.
- () Set the LOW-HIGH switch to the position that produces the highest-on-scale reading.

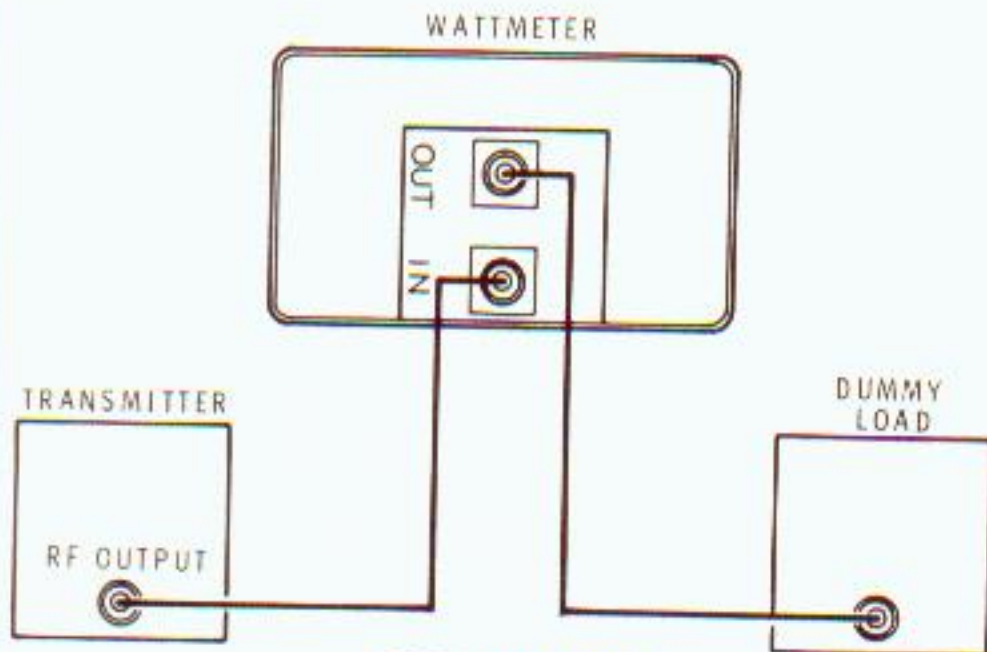

PICTORIAL 3-3

- () Transmit a CW, FM signal; note the reading on the FWD meter.
- () Push the PEP-AVG switch to its PEP (in) position and allow the PEP reading a short time to settle. Note the reading on the FWD meter; it should be the same as the first reading. If it is not, refer to Pictorial 3-2 and adjust PEP FWD CAL control R5 until you get the same reading as in the previous step.
- () Operate the PEP-AVG switch in and out as you perform the preceding

two steps until the meter indication is the same for both switch positions.

- () Turn off the transmitter.
- () On the remote sensor assembly, connect the transmitter output to the OUT coaxial jack and the dummy load cable to the IN coaxial jack.
- () Set the PEP-AVG switch to AVG (out).
- () Tune the transmitter to produce a high-scale REF meter reading. Note the reading on the REF meter. Reduce the transmitter power if necessary.
- () Push the PEP-AVG switch to the PEP (in) position. If the REF meter does not indicate the same reading as in the previous step, adjust circuit board PEP REF CAL control R3 until the reading is the same.
- () Operate the PEP-AVG switch in and out as you perform the previous two steps until the meter indication is the same for both switch positions. Leave the switch in the AVG position.
- () Turn off the transmitter and disconnect the cables from the remote sensor.

This completes the "Tests and Adjustments" of your VHF Dual Wattmeter. Proceed to "Final Assembly."

FINAL ASSEMBLY

Refer to Pictorial 4-1 (Illustration Booklet, Page 9) for the following steps.

NOTE: Perform the next step only if you are **not** going to mount the remote sensor assembly away from the meter assembly.

- () Position the remote sensor as shown in the Pictorial. Remove the three bottom housing screws from the sensor assembly. Position the remote sensor into the cabinet as shown and secure it with the three hex head sheet metal screws you just removed.
- () Prepare the two side trim strips as follows: Place two 6-32 \times 5/16" truss head screws through each side trim strip. Then place a #6 flat washer and a #6 lockwasher on the screw. Just start a 6-32 nut onto the end of each screw.
- () Position each side strip down onto the top side edges of the cabinet bottom "brushed side" out as shown in the Pictorial, making sure the flat washers are inside the cabinet.
- () Lower the cabinet top down behind the side trim strips. Make sure the front and rear edges of the two cabinet halves are aligned; then tighten the four side trim strip mounting screws.
- () Coil the sensor cable and push it into the cabinet at the side of the sensor assembly.

REMOTE SENSOR MOUNTING

Refer to Pictorial 4-2 (Illustration Booklet, Page 9) for the following steps.

NOTE: Disregard the following steps if you have installed the remote sensor into the Wattmeter Cabinet.

Refer to Pictorial 4-2 for the following steps.

- () Draw a horizontal line on the mounting surface for the remote sensor assembly.
- () On the horizontal line, draw two short intersecting lines to the dimensions as shown in the Pictorial.
- () At the intersecting lines, start two small holes for the mounting screws.
- () Start each of the #6 \times 1" sheet metal screws into the mounting surface and turn them down until they are about 1/16" from the wall or panel. Place the remote sensor onto the mounting screws.

This completes the assembly of your VHF Dual Wattmeter. Proceed to "Operation and Installation."

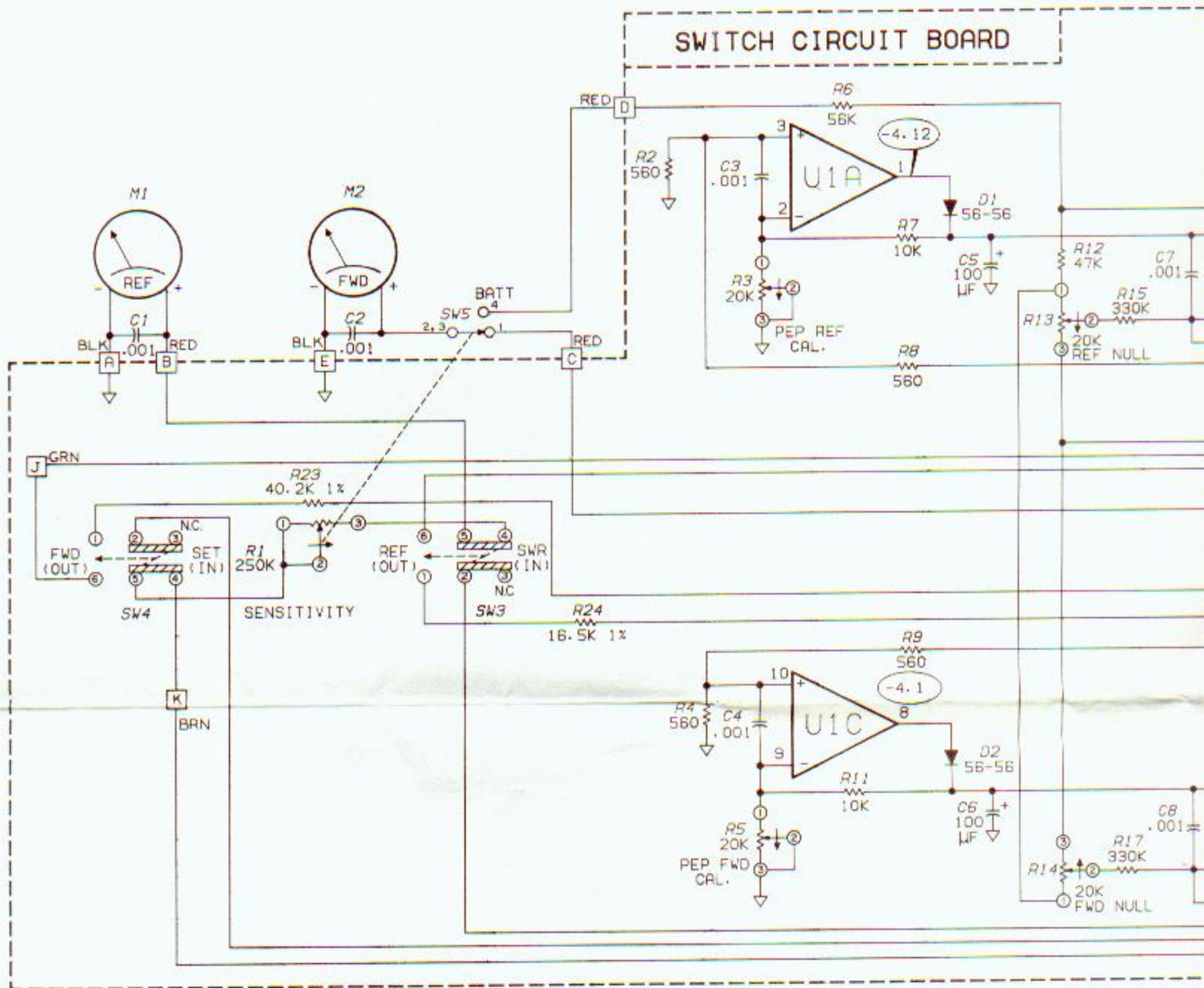

**SCHEMATIC OF THE
HEATHKIT®
VHF DUAL WATTMETER
MODEL HM-2141**

NOTES:

1. ALL RESISTOR VALUES ARE IN OHMS (Ω); (K = 1000).
2. ALL RESISTORS ARE 1/4-WATT, 5% TOLERANCE UNLESS OTHERWISE NOTED.
3. CAPACITOR VALUES LESS THAN 1 ARE IN μF (MICRO-FARADS). VALUES OF 1 OR GREATER ARE IN pF (PICOFARADS) UNLESS OTHERWISE MARKED.

BOARD

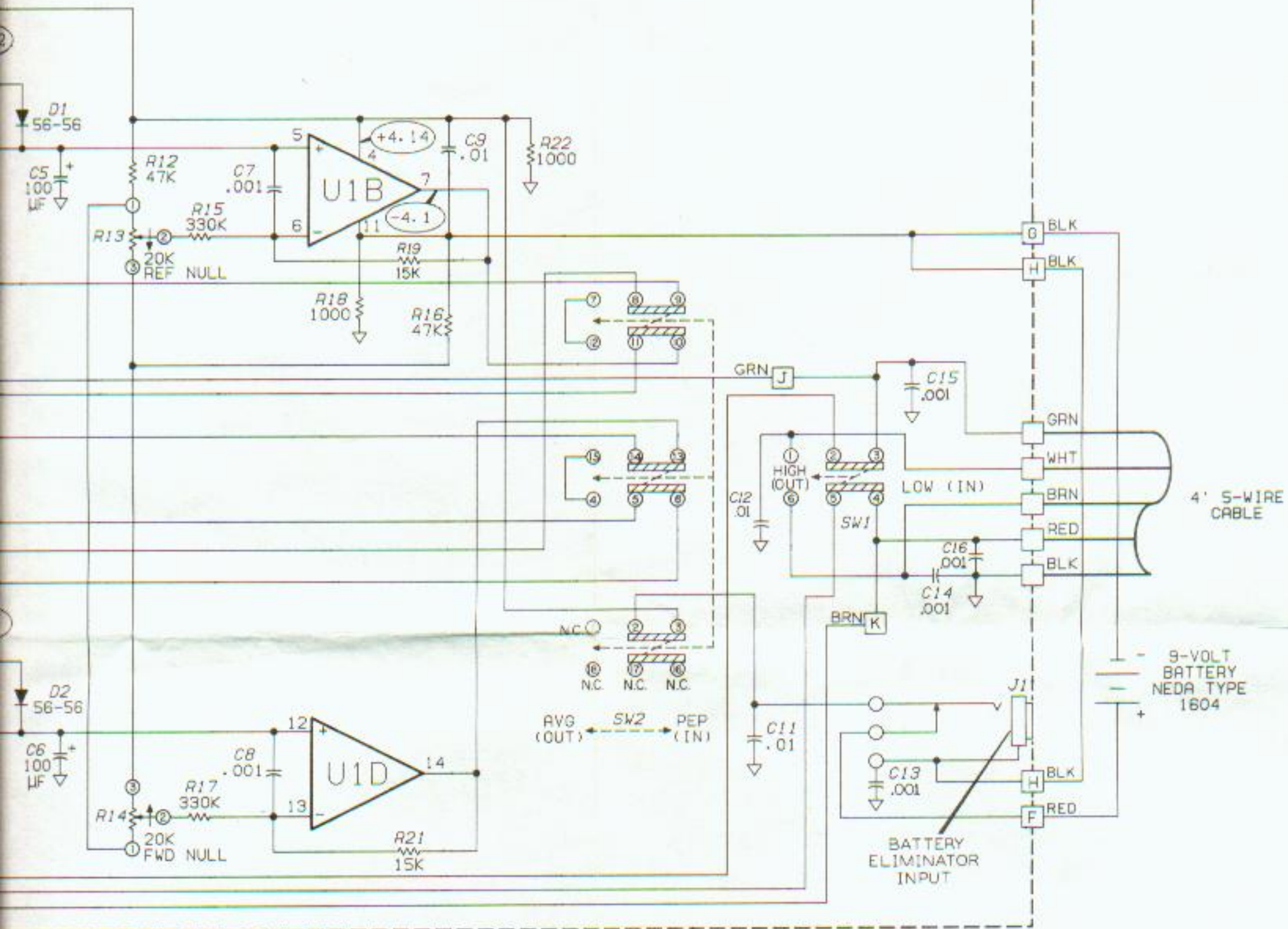





F THE

METER
141

N OHMS (Ω):

, 5% TOLERANCE

AN 1 ARE IN μ F (MICRO-
GREATER ARE IN pF
WISE MARKED.

4.  THIS SYMBOL INDICATES A CHASSIS GROUND.
5.  THIS SYMBOL INDICATES A CIRCUIT BOARD GROUND.
6.  THIS SYMBOL INDICATES A CIRCUIT BOARD WIRE CONNECTION.
7.  THIS SYMBOL INDICATES THE CLOCKWISE ROTATION OF A CONTROL.
8.  THIS SYMBOL INDICATES A DC VOLTAGE MEASURED FROM THE POINT INDICATED TO CIRCUIT BOARD GROUND.

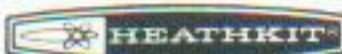

OPERATION AND INSTALLATION

Refer to Pictorial 5-1 (Illustration Booklet, Page 10) for the following information.

The VHF Dual Wattmeter was designed for amateur radio use, in the frequency spectrum between 50 and 175 MHz. The meter will help you:

- Tune your transmitter for its optimum output power.
- Adjust your antenna and antenna tuner for minimum standing wave ratios (VSWR).
- Provide you with an accurate power measurement when you use a good 50-ohm dummy load or 1.1:1 (or less) VSWR antenna.

The wattmeter can be installed at any point in your transmission line and it will indicate the VSWR at that point. It is usually convenient to install the remote sensor assembly in the "ham shack" to measure the VSWR your transmitter will "see." Pictorial 5-1 (Illustration Booklet, Page 10) illustrates several examples of amateur stations which incorporate Wattmeters.

You can obtain the best results with readings that are greater than midrange of your Meter. Although you can use the Wattmeter with low-powered transmitters, you will get the best results when you use it with transmitters that produce 5 watts or more output since its accuracy is specified in percent of full scale.

CONTROL AND SWITCH FUNCTIONS

Refer to Pictorial 5-2 (Illustration Booklet, Page 11) for the following information.

LOW-HIGH switch — This pushbutton switch should be set to LOW (in) for all transmitters (or amplifiers) which produce an output of less than 30 watts (PEP) or 30 watts (AVG). Set the switch to HIGH (out) for output power from 30 to 300 watts output (PEP) or 300 watts (AVG).

PEP-AVG switch — Set this pushbutton switch to PEP (in) for single sideband operation. For all other transmitting modes, set the switch to AVG (out). **IMPORTANT:** When the Meter is not in use, set this switch to the AVG position; this disconnects the battery circuit.

SWR-REF switch — Set this pushbutton switch to REF (out) to read the amount of reflected power (in watts) directly from the REF meter. Set the switch to SWR (in) to take standing-wave readings from the REF meter. **NOTE:** This procedure will be described in "SWR Measurements" which follows.

SET-FWD switch — Set this pushbutton switch to FWD (out) as you perform tuning adjustments or at any time you wish to observe the forward output power (in watts) of the transmitted signal on the FWD meter. The SET (in) switch position allows you to adjust the SENSITIVITY control to the "SET" mark on the FWD meter (see "SWR Measurements").