

HEATHKIT[®] MANUAL

for the

DECADE RESISTANCE KIT Model IN-3117

595-1995

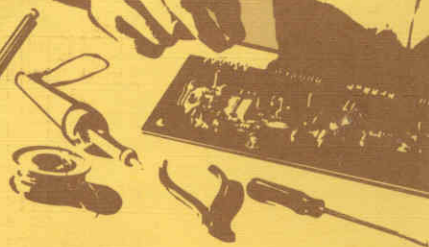
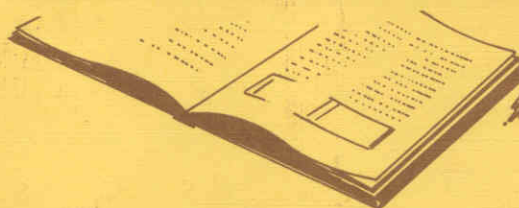

HEATH COMPANY • BENTON HARBOR, MICHIGAN

YOUR HEATHKIT 90-DAY LIMITED WARRANTY**Consumer Protection Plan for Heathkit Consumer Products**

Welcome to the Heath family. We believe you will enjoy assembling your kit and will be pleased with its performance. Please read this Consumer Protection Plan carefully. It is a **LIMITED WARRANTY** as defined in the U.S. Consumer Product Warranty and Federal Trade Commission Improvement Act. This warranty gives you specific legal rights, and you may also have other rights which vary from state to state.

Heath's Responsibility

PARTS — Replacements for factory defective parts will be supplied free for 90 days from date of purchase. Replacement parts are warranted for the remaining portion of the original warranty period. You can obtain warranty parts direct from Heath Company by writing or telephoning us at (616) 982-3571. And we will pay shipping charges to get those parts to you... anywhere in the world.

SERVICE LABOR — For a period of 90 days from the date of purchase, any malfunction caused by defective parts or error in design will be corrected at no charge to you. You must deliver the unit at your expense to the Heath factory, any Heathkit Electronic Center (units of Veritechnology Electronics Corporation), or any of our authorized overseas distributors.

TECHNICAL CONSULTATION — You will receive free consultation on any problem you might encounter in the assembly or use of your Heathkit product. Just drop us a line or give us a call. Sorry, we cannot accept collect calls.

NOT COVERED — The correction of assembly errors, adjustments, calibration, and damage due to misuse, abuse, or negligence are not covered by the warranty. Use of corrosive solder and/or the unauthorized modification of the product or of any furnished component will void this warranty in its entirety. This warranty does not include reimbursement for inconvenience, loss of use, customer assembly, set-up time, or unauthorized service.

This warranty covers only Heath products and is not extended to other equipment or components that a customer uses in conjunction with our products.

SUCH REPAIR AND REPLACEMENT SHALL BE THE SOLE REMEDY OF THE CUSTOMER AND THERE SHALL BE NO LIABILITY ON THE PART OF HEATH FOR ANY SPECIAL, INDIRECT, INCIDENTAL OR CONSEQUENTIAL DAMAGES, INCLUDING BUT NOT LIMITED TO ANY LOSS OF BUSINESS OR PROFITS, WHETHER OR NOT FORSEEABLE.

Some states do not allow the exclusion or limitation of incidental or consequential damages, so the above limitation or exclusion may not apply to you.

Owner's Responsibility

EFFECTIVE WARRANTY DATE — Warranty begins on the date of first consumer purchase. You must supply a copy of your proof of purchase when you request warranty service or parts.

ASSEMBLY — Before seeking warranty service, you should complete the assembly by carefully following the manual instructions. Heathkit service agencies cannot complete assembly and adjustments that are customer's responsibility.

ACCESSORY EQUIPMENT — Performance malfunctions involving other non-Heath accessory equipment, (antennas, audio components, computer peripherals and software, etc.) are not covered by this warranty and are the owner's responsibility.

SHIPPING UNITS — Follow the packing instructions published in the assembly manuals. Damage due to inadequate packing cannot be repaired under warranty.

If you are not satisfied with our service (warranty or otherwise) or our products, write directly to our Director of Customer Service, Heath Company, Benton Harbor, MI 49022. He will make certain your problems receive immediate, personal attention.

The following telephone numbers are direct lines to the departments listed:

Kit orders and delivery information	(616) 982-3411
Credit	(616) 982-3561
Replacement Parts	(616) 982-3571

*Technical Assistance Phone Numbers
8:00 A.M. to 4:30 P.M., EST, Weekdays Only*

Audio	(616) 982-3310
Amateur Radio	(616) 982-3296
Test Equipment, Weather Instruments and Home Clocks	(616) 982-3315
Television	(616) 982-3307
Aircraft, Marine, Security, Scanners, Automotive, Appliances and General Products	(616) 982-3496
Computers — Hardware	(616) 982-3309
Computers — Software	
Operating Systems, Languages, Utilities	(616) 982-3860
Application Programs	(616) 982-3884

Assembly and Operation of the



DECADE RESISTANCE KIT

MODEL IN-3117

HEATH COMPANY
BENTON HARBOR, MICHIGAN 49022

Copyright © 1977
Heath Company
All Rights Reserved
Printed in the United States of America

TABLE OF CONTENTS

Specifications	2
Introduction	2
Circuit Description	3
Parts List	3
Schematic . . . (fold-out from page)	3
Construction Notes	4
Step-by-Step Assembly	5
Initial Operation Check	9
Final Assembly	9
Operation	10
In Case of Difficulty	10
Warranty	Inside Front Cover
Customer Service	Inside Rear Cover

The Heath Company reserves the right to discontinue products and to change specifications at any time without incurring any obligation to incorporate new features in products previously sold.

SPECIFICATIONS

Range.	1 Ω to 999,999 Ω in 1 Ω steps.	
Resistors.	Precision, 1/2% accuracy, 1 watt.	
Maximum Current For Each Range.	<u>WORKING RATING</u>	<u>MAXIMUM RATING</u>
	X1 - 500 ma.	1000 ma.
	X10 - 150 ma.	300 ma.
	X100- 50 ma.	100 ma.
	X1K- 15 ma.	30 ma.
	X10K- 5 ma.	10 ma.
	X100K- 1.5 ma.	3 ma.
Minimum DC Resistance.025 Ω at terminals with all switches set at zero.	
Dimensions.	7-1/2" wide x 5" high x 6-5/8" deep.	
Net Weight.	2-1/2 lbs.	

INTRODUCTION

The IN-3117 Decade Resistance Kit was designed as an accurate laboratory-type instrument for use wherever electrical measurements involving resistors are made. The wide range of available resistance values make the IN-3117 invaluable as a variable multiplier or shunt, a variable substitution resistor, or as an arm for DC and AC bridges. The Heathkit Decade Capacitance Kit makes an ideal companion with the IN-3117 for solving resistance and capacitance networks where a large range of values are necessary.

sistance and capacitance networks where a large range of values are necessary.

Refer to the "Kit Builders Guide" for complete information on unpacking, parts identification, tools, wiring, soldering, and step-by-step assembly procedures.

CIRCUIT DESCRIPTION

The series arrangement of the range switches and the precision resistors as shown on the Schematic Diagram will yield any resistance value from 1 to 999,999 Ω in 1 Ω steps. Each resistor is rated to be within 1/2% of its ohmic value for precision applications. The 0 position of the range switches allows the resistors to be bypassed if desired. The multiplier printed

beneath each range switch on the front panel indicates the value of each resistor for that particular switch. The "shorting-type" switches with make-before-break action permit smooth adjustment of the resistance value without opening or shorting of the circuit.

PARTS LIST

Unpack the kit carefully and check each part against the Parts List. The numbers in front of the Part Number correspond to the picture of that part for quick and positive identification.

To order a replacement part, use the Parts Order Form furnished with this kit. If a Parts Order Form is not available, refer to "Replacement Parts" inside the rear cover of the Manual. For pricing information, refer to the separate "Heath Parts Price List."

PART No.	PARTS Per Kit	DESCRIPTION
90-352-3	1	Cabinet shell
203-1853-1	1	Front panel

SHEET METAL PARTS

90-352-3	1	Cabinet shell
203-1853-1	1	Front panel

HARDWARE

250-8	4	#6 sheet metal screw
250-89	4	6-32 screw
252-3	4	6-32 nut
252-7	6	Control nut

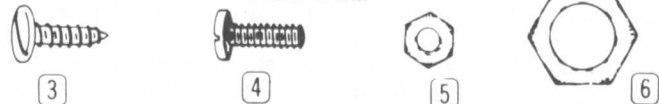

PART No.	PARTS Per Kit	DESCRIPTION
2-46-1	9	1 Ω
2-47-1	9	10 Ω
2-48-1	9	100 Ω
2-49-1	9	1 K Ω
2-50-1	9	10 K Ω
2-51-1	9	100 K Ω

RESISTORS (Precision 1/2% 1 Watt)

2-46-1	9	1 Ω
2-47-1	9	10 Ω
2-48-1	9	100 Ω
2-49-1	9	1 K Ω
2-50-1	9	10 K Ω
2-51-1	9	100 K Ω

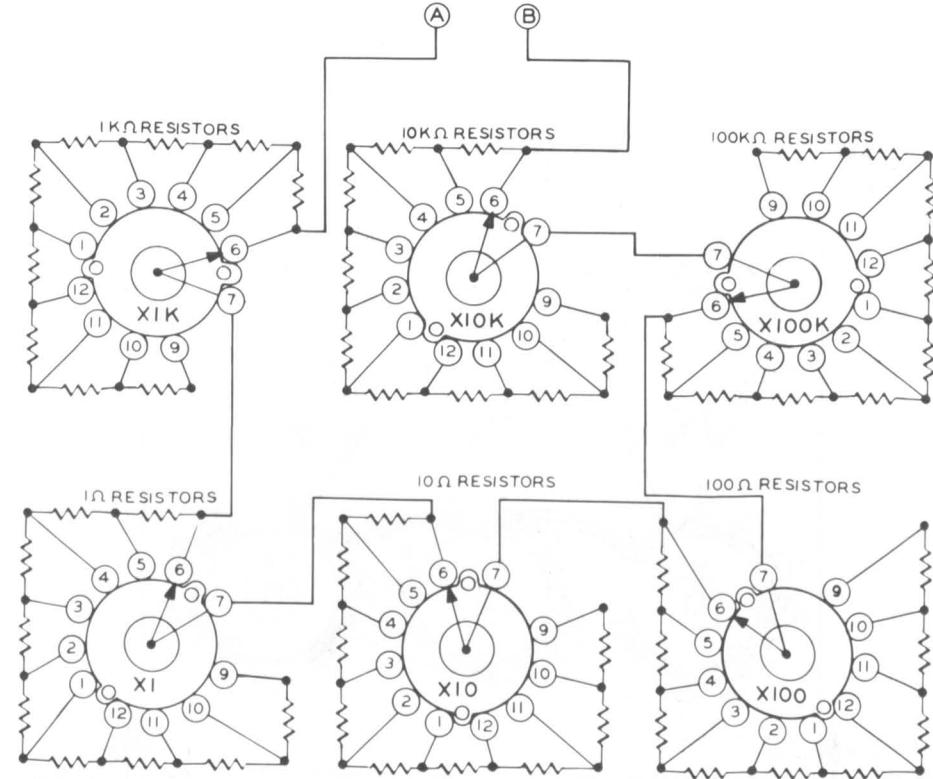
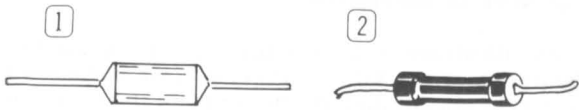

SCHMATIC OF THE HEATHKIT®
DECADE RESISTANCE KIT MODEL IN-3117

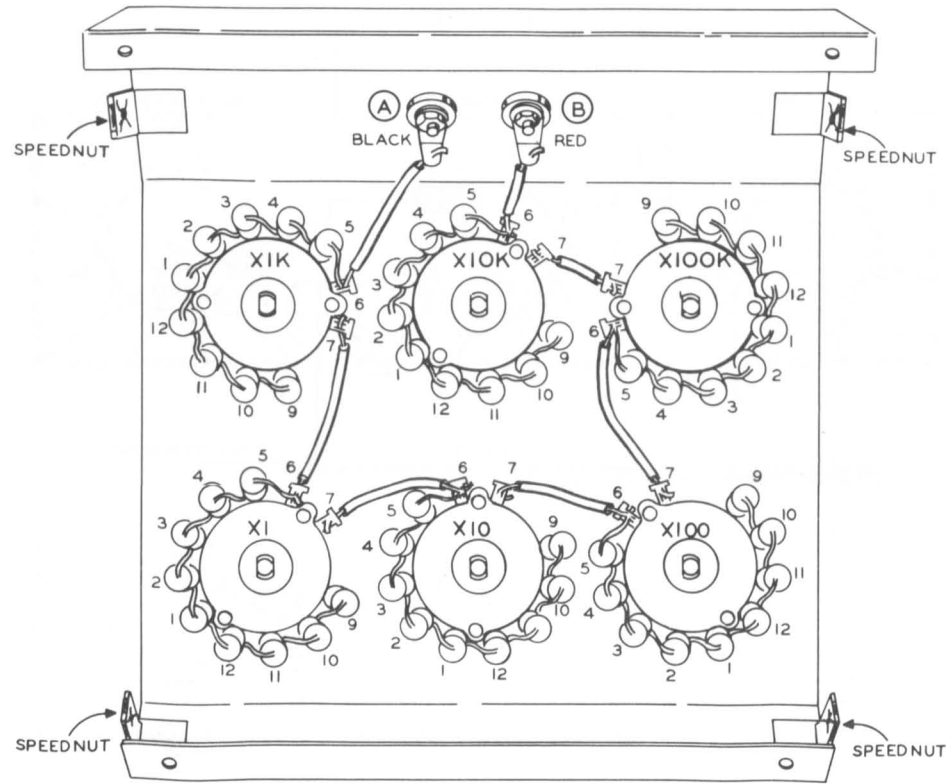

PICTORIAL 1

PART No.	PARTS Per Kit	DESCRIPTION
Hardware (cont'd.)		
7 252-22	4	Speednut
8 253-10	6	Control flat washer
9 254-4	6	Control lockwasher
10 259-1	2	Solder lug

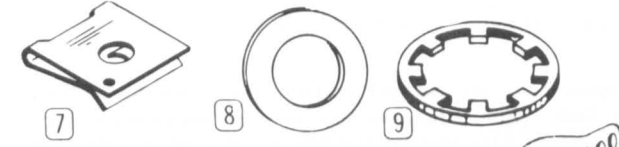

MISCELLANEOUS

11 63-450	6	Range switch
12 100-16-2	1	Binding post cap, black
100-16-18	1	Binding post cap, red
13 427-3	2	Binding post base
14 75-17	4	Binding post insulator
15 261-49	4	Rubber foot

PART No.	PARTS Per Kit	DESCRIPTION
Miscellaneous (cont'd)		
344-6	1	Length hookup wire
462-999	6	Knob
16 455-619	6	Knob bushing
391-34	1	Blue and white label
597-260	1	Parts Order Form
597-308	1	Kit Builders Guide
	1	Manual (See front cover for part number.)
		Solder

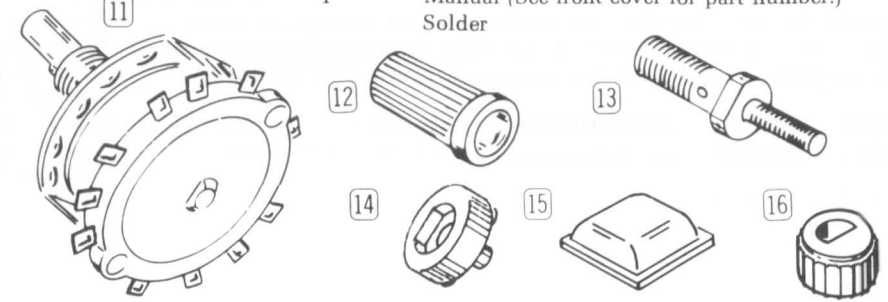

CONSTRUCTION NOTES

The following instructions are presented in a logical step-by-step sequence to enable you to complete your kit with the least possible confusion. Be sure to read each step all the way through before beginning the specified operation. Also read several steps ahead of the actual step being performed. This will familiarize you with the relationship of the subsequent operations. When the step is completed, check it off in the space provided. This is particu-

larly important as it may prevent errors or omissions, especially if your work is interrupted.

In general, the illustrations in this manual correspond to the actual configuration of the kit; however, in some instances the illustrations may be slightly distorted to facilitate clearly showing all of the parts.

The abbreviation "NS" indicates that a connection should not be soldered yet as other wires will be added. When the last wire is installed, the terminal should be soldered and the abbreviation "S" is used to indicate this. Note that a number will appear after each solder instruction. This number indicates the number of leads that are supposed to be connected to the terminal in point before it is soldered. For example, if the instruction reads, "Connect a lead to lug 1 (S-2)," it will be understood that there will be two leads connected to the terminal at the time it is soldered.

ROSIN CORE SOLDER HAS BEEN SUPPLIED WITH THIS KIT. THIS TYPE OF SOLDER MUST BE USED FOR ALL SOLDERING IN THIS KIT. ALL GUARANTEES ARE VOIDED AND WE WILL NOT REPAIR OR SERVICE EQUIPMENT IN WHICH ACID CORE SOLDER OR PASTE FLUXES HAVE BEEN USED. IF ADDITIONAL SOLDER IS NEEDED, BE SURE TO PURCHASE ROSIN CORE (60:40 or 50:50 TIN-LEAD CONTENT) RADIO TYPE SOLDER.

STEP-BY-STEP ASSEMBLY

Refer to Pictorial 1 (fold-out from Page 4) for the following steps.

- () Mount binding posts at A and B with black and red caps, respectively. Note solder lug positioning. See Detail 1A for assembly, using the binding post insulators.
- () Locate all nine 100 K Ω resistors so that they will be readily available. (Make sure that all nine of the resistors are 100 K Ω).
- () Position one of the range switches so that a rear view of the switch will correspond to that shown in Detail 1B.

Position the work, if possible, so that gravity will help to keep the solder where you want it. The joint to be soldered should be heated with the flat side of the soldering iron tip sufficiently to melt the solder. Apply only enough solder to the heated terminal to thoroughly wet the junction. Remove the solder and then the iron when a smooth soldered junction appears. Do not move the leads until the solder is solidified.

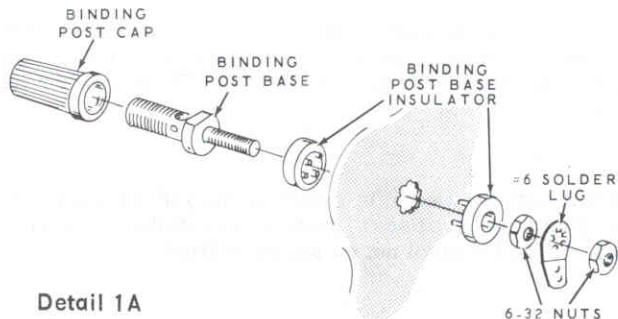

Detail 1A

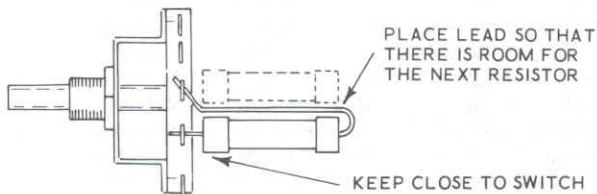
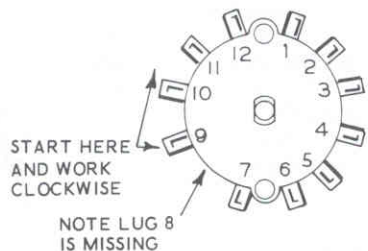

Detail 1 B

- () Position one of the 100 K Ω resistors and its leads as suggested in Detail 1B and connect it between lugs 9 (S-1) and 10 (NS).
- () Install another 100 K Ω resistor between lugs 10 (S-2) and 11 (NS).
- () In the same manner, install the remaining seven 100 K Ω resistors. Make sure the resistors connected to lugs 12 and 1 do not touch the switch rivet. Do not solder lugs 6 and 7.
- () Mount and position this switch at the 100 K location shown in Pictorial 1. Use a control lockwasher, control flat washer, and control nut as shown in Detail 1C.

- () Wire and mount the 10K, 1K, 100, 10 and 1 range switches in the same manner as outlined for the 100K switch. See Pictorial 1 for the proper switch position and location.

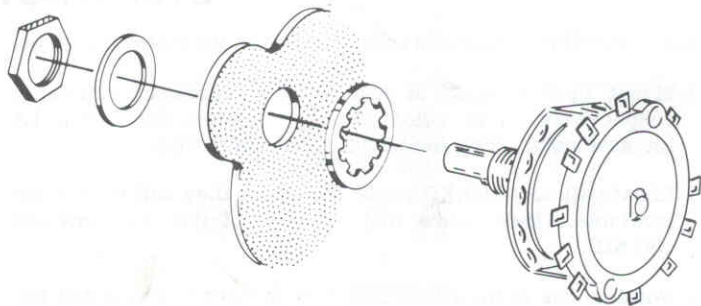

Detail 1C

Strip 1/4" of insulation from each end of the hookup wire to be connected between the following lugs. See Pictorial 1 for proper wire positioning.

FROM LUGTO LUG

- | | |
|-----------------------------|-------------------------------------|
| () 6 of switch 10 K (S-2) | Solder lug of binding post B (S-1). |
| () 7 of switch 100 K (S-1) | 7 of switch 10 K (S-1). |
| () 7 of switch 100 (S-1) | 6 of switch 100 K (S-2). |
| () 6 of switch 100 (S-2) | 7 of switch 10 (S-1). |
| () 6 of switch 10 (S-2) | 7 of switch 1 (S-1). |
| () 6 of switch 1 (S-2) | 7 of switch 1 K (S-1). |
| () 6 of switch 1K (S-2) | Solder lug of binding post A (S-1). |

This completes the wiring. Check all the resistors and other wiring for proper solder connections. Make sure each resistor and its lead does not touch the adjacent resistor and its lead.

Detail 1D shows how to keep the binding post caps from falling off. This is done by slightly spreading the open end of the binding posts with a phillips screwdriver after the binding post caps have been screwed on. Tap the screwdriver lightly.

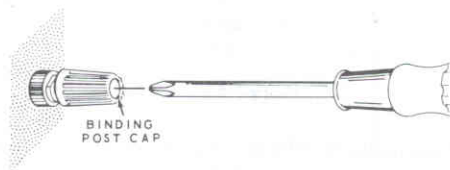

Detail 1D

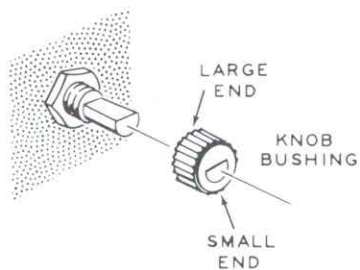

Detail 1E

Refer to Detail 1E and notice that the knob bushing is tapered. Be sure, in the next step, to place this bushing on the shaft with the small end facing out, or the knob will not slide onto it. (Roll the bushing on a flat surface if you are unsure about it; the bushing will gradually turn toward the small end.)

- () Push a knob bushing onto each of the six switch shafts. Then turn all switch shafts to their full counterclockwise position.

In the following step you will install knobs on the shafts as shown in Detail 1F. Perform these steps carefully, since it is difficult to remove a bushing from a knob once it is fully inserted.

- () Install knobs on the six shafts. Line up the pointers with the 0 mark on the panel.

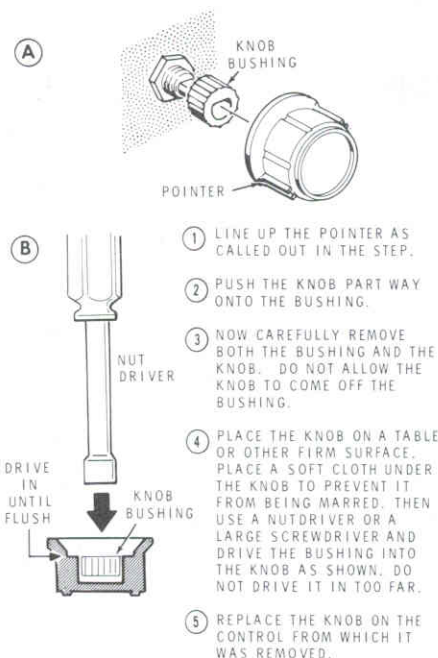

Detail 1F

INITIAL OPERATION CHECK

If an ohmmeter is handy, the range switch contacts and the wiring may be checked for proper operation. If you do not have an ohmmeter, proceed to the Final Assembly section. Connect the ohmmeter leads to the red and black binding posts of the IN-3117. Set all the range switches in the 0 position. The ohmmeter should read 0. Keep in mind that the measured resistances will vary, depending on the accuracy of your ohmmeter. Now advance the X1 range switch. With the ohmmeter set properly, it should

increase by 1 Ω increments. Advance and check the X10 range switch for 10 Ω increments. All of the switches should be checked in this manner. If a short circuit, open circuit, or improper incremental resistance increase is detected as the switches are rotated, it can be remedied very quickly by checking the associated switch circuitry. If necessary, refer to the In Case Of Difficulty section. If operation is as described, you may assume that it is properly constructed.

FINAL ASSEMBLY

- () Place a speednut on each of the small L brackets located on each side of the front panel. The flat side of each speednut should face toward the outside of the panel.
- () Install a rubber foot at each corner on the bottom of the cabinet shell. First remove the protective backing, then press the foot firmly into place.
- () Carefully peel away the backing paper from the blue and white identification label. Then press the label onto the inside of the cabinet. Be sure to refer to the numbers on this label in any communications you have with the Heath Company about this kit.
- () Mount the cabinet shell to the front panel, using 6-32 screws on the L brackets and four #6 sheet metal screws on the bottom of the front panel.

OPERATION

The Decade Resistance Kit is very simple to operate. Just connect it to the circuit under test and adjust the range switches for the particular resistance needed. The total value of resistance is determined by adding the settings of the six range switches. For example; if the range switches were set as follows: The X1 switch at 5, the X10 switch at 7, the X100 switch at 0, the 1K switch at 9, the X10K switch at 1, and the X100K switch

at 4, the total resistance presented at the binding posts would be 419,075 Ω or 419,075 K Ω .

CAUTION: Observe the current limitations as outlined in the Specifications. This means the highest range switch in use (off of 0 position) will determine the maximum allowable current.

IN CASE OF DIFFICULTY

1. Recheck the wiring. Trace each lead in colored pencil on the Pictorial as it is checked. It is frequently helpful to have a friend check your work. Someone who is not familiar with the unit may notice something consistently overlooked by the constructor.
 2. It is interesting to note that about 90% of the kits that are returned for repair do not function properly due to poor connections and soldering. Therefore, many troubles can be eliminated by reheating all connections to make sure that they are soldered properly.
 3. Check the values of the component parts. Be sure that the proper part has been wired into the circuit, as shown in the pictorial diagrams and as called out in the wiring instructions.
 4. Check for bits of solder, wire ends or other foreign matter which may be lodged in the wiring beneath the panel.
 5. Repeating the Initial Operation Check procedure may be helpful in pinpointing the problem.
- NOTE:** In an extreme case where you are unable to resolve a difficulty, refer to the "Customer Service" information inside the rear cover of the Manual. Your Warranty is located inside the front cover.



CUSTOMER SERVICE

REPLACEMENT PARTS

Please provide complete information when you request replacements from either the factory or Heath Electronic Centers. Be certain to include the **HEATH** part number exactly as it appears in the parts list.

Replacement parts are maintained specifically to repair Heath products. Parts sales for other reasons will be declined.

ORDERING FROM THE FACTORY

Print all of the information requested on the parts order form furnished with this product and mail it to Heath. For telephone orders (parts only) dial 616 982-3571. If you are unable to locate an order form, write us a letter or card including:

- Heath part number.
- Model number.
- Date of purchase.
- Location purchased or invoice number.
- Nature of the defect.
- Your payment or authorization for COD shipment of parts not covered by warranty.

Mail letters to: Heath Company
Benton Harbor
MI 49022
Attn: Parts Replacement

Retain original parts until you receive replacements. Parts that should be returned to the factory will be listed on your packing slip.

OBTAINING REPLACEMENTS FROM HEATH ELECTRONIC CENTERS

For your convenience, "over the counter" replacement parts are available from the Heath Electronic Centers listed in your catalog. Be sure to bring in the original part and purchase invoice when you request a warranty replacement from a Heath Electronic Center.

TECHNICAL CONSULTATION

Need help with your kit? — Self-Service? — Construction? — Operation? — Call or write for assistance, you'll find our Technical Consultants eager to help with just about any technical problem except "customizing" for unique applications.

The effectiveness of our consultation service depends on the information you furnish. Be sure to tell us:

- The Model number and Series number from the blue and white label.
- The date of purchase.
- An exact description of the difficulty.
- Everything you have done in attempting to correct the problem.

Also include switch positions, connections to other units, operating procedures, voltage readings, and any other information you think might be helpful.

Please do not send parts for testing, unless this is specifically requested by our Consultants.

Hints: Telephone traffic is lightest at midweek — please be sure your Manual and notes are on hand when you call.

Heathkit Electronic Center facilities are also available for telephone or "walk-in" personal assistance.

REPAIR SERVICE

Service facilities are available, if they are needed, to repair your completed kit. (Kits that have been modified, soldered with paste flux or acid core solder, cannot be accepted for repair.)

If it is convenient, personally deliver your kit to a **Heathkit Electronic Center**. For warranty parts replacement, **supply a copy of the invoice or sales slip.**

If you prefer to ship your kit to the factory, attach a letter containing the following information directly to the unit:

- Your name and address.
- Date of purchase and invoice number.
- Copies of all correspondence relevant to the service of the kit.
- A brief description of the difficulty.
- Authorization to return your kit COD for the service and shipping charges. (This will reduce the possibility of delay.)

Check the equipment to see that all screws and parts are secured. (Do not include any wooden cabinets or color television picture tubes, as these are easily damaged in shipment. Do not include the kit Manual.) Place the equipment in a strong carton with at least **THREE INCHES** of *resilient* packing material (shredded paper, excelsior, etc.) on all sides. Use additional packing material where there are protrusions (control sticks, large knobs, etc.). If the unit weighs over 15 lbs., place this carton in another one with 3/4" of packing material between the two.

Seal the carton with reinforced gummed tape, tie it with a strong cord, and mark it "Fragile" on at least two sides. Remember, the carrier will not accept liability for shipping damage if the unit is insufficiently packed. Ship by prepaid express, United Parcel Service, or insured Parcel Post to:

Heath Company
Service Department
Benton Harbor, Michigan 49022



HEATH COMPANY • BENTON HARBOR, MICHIGAN
THE WORLD'S FINEST ELECTRONIC EQUIPMENT IN KIT FORM

LITHO IN U.S.A.