

PRICE \$1.00



**Assembling  
and Using Your...**

# Heathkit

**CAPACI-TESTER**

MODEL CT-1

**HEATH COMPANY**

*A Subsidiary of Daystrom Inc.*

**BENTON HARBOR, MICHIGAN**

# STANDARD COLOR CODE — RESISTORS AND CAPACITORS

INSULATED UNINSULATED Color	FIRST RING BODY COLOR First Figure	SECOND RING END COLOR Second Figure	THIRD RING DOT COLOR Multiplier
BLACK	0	0	None
BROWN	1	1	0
RED	2	2	00
ORANGE	3	3	,000
YELLOW	4	4	0,000
GREEN	5	5	00,000
BLUE	6	6	000,000
VIOLET	7	7	0,000,000
GRAY	8	8	00,000,000
WHITE	9	9	000,000,000

**AXIAL LEAD RESISTOR**

**DISC CERAMIC RMA CODE**

**RADIAL LEAD DOT RESISTOR**

**5-DOT RADIAL LEAD CERAMIC CAPACITOR**

**EXTENDED RANGE TC CERAMIC HICAP**

**RADIAL LEAD (BAND) RESISTOR**

**BY-PASS COUPLING CERAMIC CAPACITOR**

**AXIAL LEAD CERAMIC CAPACITOR**

The standard color code provides all necessary information required to properly identify color coded resistors and capacitors. Refer to the color code for numerical values and the zeroes or multipliers assigned to the colors used. A fourth color band on resistors determines tolerance rating as follows: Gold = 5%, silver = 10%. Absence of the fourth band indicates a 20% tolerance rating.

The physical size of carbon resistors is determined by their wattage rating. Carbon resistors most commonly used in Heathkits are 1/2 watt. Higher wattage rated resistors when specified are progressively larger in physical size. Small wire wound resistors 1/2 watt, 1 or 2 watt may be color coded but the first band will be double width.

## MOLDED MICA TYPE CAPACITORS

<p><b>CURRENT STANDARD CODE</b></p> <p>JAN &amp; 1948 RMA CODE</p>	<p><b>RMA 3-DOT (OBSOLETE) RATED 500 W.V.D.C. ± 20% TOL.</b></p>	<p><b>BUTTON SILVER MICA CAPACITOR</b></p>
<p><b>RMA (5-DOT OBSOLETE CODE)</b></p>	<p><b>RMA 6-DOT (OBSOLETE)</b></p>	<p><b>RMA 4-DOT (OBSOLETE)</b></p>

## MOLDED PAPER TYPE CAPACITORS

<p><b>TUBULAR CAPACITOR</b></p> <p>Normally stamped for value</p> <p>A 2 digit voltage rating indicates more than 900 V. Add 2 zeros to end of 2 digit number.</p>	<p><b>MOLDED FLAT CAPACITOR Commercial Code</b></p>	<p><b>JAN. CODE CAPACITOR</b></p>
--	---	-----------------------------------

The tolerance rating of capacitors is determined by the color code. For example: red = 2%, green = 5%, etc. The voltage rating of capacitors is obtained by multiplying the color value by 100. For example: orange = 3 × 100 or 300 volts. Blue = 6 × 100 or 600 volts.

In the design of Heathkits, the temperature coefficient of ceramic or mica capacitors is not generally a critical factor and therefore Heathkit manuals avoid reference to temperature coefficient specifications.

# ASSEMBLY AND OPERATION OF THE HEATHKIT CAPACI-TESTER MODEL CT-1



## SPECIFICATIONS

**Range:**

Open Test:..... 50  $\mu\mu\text{fd}$  to infinity.  
 Shunted by more than:  
 2  $\text{K}\Omega$  at 50  $\mu\mu\text{fd}$ ,  
 400  $\Omega$  at 100  $\mu\mu\text{fd}$ ,  
 30  $\Omega$  at 350  $\mu\mu\text{fd}$  or more.

Short Test:..... Up to 20  $\mu\text{fd}$  shunted by at least 10  $\Omega$ . (All types of capacitors except electrolytic.)

**Test Frequencies:**

Short Test:..... 60 cycles.  
 Open Test:..... 19 megacycles.

Power Requirements:..... 105-125 volts, 50-60 cycles AC, 5 watts.

Cabinet Size:..... 7 3/8" high, 4 11/16" wide by 4 1/8" deep.

Shipping Weight:..... 3 1/2 lbs.



## INTRODUCTION

The Heathkit model CT-1 Capacitor Tester is an instrument which will disclose open or shorted capacitors without removing them from the circuit. It is an extremely simple instrument, both to construct and operate, but yet an instrument which should give many years of good service if the assembly instructions are followed carefully. By not trying to "out-do" the manual to come up with an exceptionally "pretty" wiring job, you should be able to plug it in, turn it on, and yell, "Hey Ma, it works!"

An important note should be injected here: Route wiring according to the pictorial diagrams! Due to the high frequencies encountered within the tester, lead length and placement is quite critical, especially around the switch.

Only one tube is used, since it can be made to "double-in-brass". It functions as an oscillator, an indicator, and it is self-rectifying.

A five-position switch is employed, which controls the power to the instrument, selects the test being made (i. e., OPEN or SHORT), and also provides a check on the proper operation of the tester continuously. A further explanation of the switch position functions will be found in the "OPERATING" section of the manual.

## CIRCUIT DESCRIPTION

**OPEN TEST:** The triode section of the electron ray indicator tube, or "Magic Eye", is employed as a conventional Hartley oscillator, but here convention ceases. Reference to the schematic diagram will reveal a "secondary" winding coupled to the oscillator coil, with the oscillator tuned to about 19 megacycles. Now here's the catch! Coupling is "tight" enough to cause the oscillator to quit oscillating! In this respect it can be compared to a Grid Dip Meter. As coupling is increased, the absorbtive action of the coupled circuit sucks energy out of the oscillator coil, lowering the strength of the oscillation to the point where the oscillator quits altogether. Had enough oscillators for a while? Then let's proceed.

With no oscillation present, no bias is developed across the grid leak, resulting in maximum current flow through the tube. Under these conditions, the eye is open to its widest angle. When a capacitor which is not open (i. e., good or shorted) is connected across the secondary, it becomes de-tuned sufficiently to allow the circuit to oscillate. Under these circumstances, bias is developed which limits the current flow to a relatively low value, causing the eye to close. In other words, if the capacitor has continuity, the eye closes. Simple, eh?

**SHORT TEST:** A biasing voltage, obtained from the power transformer, is fed through a current limiting network to the grid of the tube. The test leads are connected between grid and ground. A shorted capacitor will short out this bias voltage, opening the eye. One which is not shorted has no effect, unless its reactance is extremely low. However, a reference is provided to determine the effect of a shorted capacitor, and unless the capacitor has a reactance of less than 10  $\Omega$  at a sixty-cycle frequency, the check is accurate. A further description of this reference can be found in the "OPERATING" section.

**POWER SUPPLY:** The power supply in this instrument consists of a power transformer only. No rectifier is necessary, since the "eye" tube is self-rectifying! When the potential on the plate is positive in respect to the cathode, current flows. When the voltage on the plate swings negative on the other half of the cycle, no current flows, and the tube just "coasts". Since AC is used on the plate and grid, proper phasing of the transformer windings is necessary.

## ABOUT THE MANUAL

With the exception of the circuit description, this manual was written for a definitely non-technical minded individual. To you with a technical background, it may seem rather elementary to have to follow a step-by-step procedure such as this manual incorporates. However, experience with all types of instruction methods has shown the method used here to be the most foolproof for both amateur and professional builders. The combination of pictures, diagrams and worded

instruction is the best for the novice. It gives him an equal chance with the experienced builder, of gaining the satisfaction of an instrument that works the first time. At the same time, the professional constructor can benefit from the self-checking procedure, which provides the fastest, most convenient and "painless" way.

The written assembly instructions in this manual are divided into small operations or steps. Each step is a complete operation. Read the entire step through, then do that operation and check it off as completed. After an interruption, it is easy to find where you left off by the check marks. Read over the last checked step and you are all ready to continue.

The major pictorials in this manual are reproduced on large separate sheets. If you fasten the appropriate pictorial on the wall above your work space, it will save you paging back and forth in the manual.

In the wiring (S) means solder this connection and (NS) means do not solder yet, as more wires will be connected to this point. If more than one wire is to be soldered at a connection point, the instructions will appear as follows (S) (3) which means solder this connection which should have three wires connected to it. This will provide a running check of multiple connections.

### **PROPER SOLDERING PROCEDURE**

Only a small percentage of Heathkit purchasers find it necessary to return an instrument for factory service. Of these, by far the largest proportion function improperly due to poor or improper soldering.

Correct soldering technique is extremely important. Good solder joints are essential if the performance engineered into the kit is to be fully realized. If you are a beginner with no experience in soldering, a half-hour's practice with odd lengths of wire and a tube socket will be a worthwhile investment.

High quality solder of the proper grade is most important. There are several different brands of solder on the market, each clearly marked "Rosin Core Radio Solder." Such solders consist of an alloy of tin and lead, usually in the proportion of 50:50. Minor variations exist in the mixture such as 40:60, 45:55, etc. with the first figure indicating the tin content. Radio solders are formed with one or more tubular holes through the center. These holes are filled with a rosin compound which acts as a flux or cleaning agent during the soldering operation.

**NO SEPARATE FLUX OR PASTE OF ANY KIND SHOULD BE USED.** We specifically caution against the use of so-called "non-corrosive" pastes. Such compounds, although not corrosive at room temperatures, will form residues when heated. The residue is deposited on surrounding surfaces and attracts moisture. The resulting compound is not only corrosive but actually destroys the insulation value of non-conductors. Dust and dirt will tend to accumulate on these "bridges" and eventually will create erratic or degraded performance of the instrument.

**NOTE: ALL GUARANTEES ARE VOIDED AND WE WILL NOT REPAIR OR SERVICE INSTRUMENTS IN WHICH ACID CORE SOLDER OR PASTE FLUXES HAVE BEEN USED. WHEN IN DOUBT ABOUT SOLDER, IT IS RECOMMENDED THAT A NEW ROLL PLAINLY MARKED "ROSIN CORE RADIO SOLDER" BE PURCHASED.**

If terminals are bright and clean and wires free of wax, frayed insulation and other foreign substances, no difficulty will be experienced in soldering. Crimp or otherwise secure the wire (or wires) to the terminal, so a good joint is made without relying on solder for physical strength. To make a good solder joint, the clean tip of the soldering iron should be placed against the joint to be soldered so that the terminal is heated sufficiently to melt solder. The solder is then placed against both the terminal and the tip of the iron and will immediately flow out over the joint. Refer to the sketch below. Use only enough solder to cover wires at the junction; it is

not necessary to fill the entire hole in the terminal with solder. Excess solder may flow into tube socket contacts, ruining the socket, or it may creep into switch contacts and destroy their spring action. Position the work so that gravity tends to keep the solder where you want it.

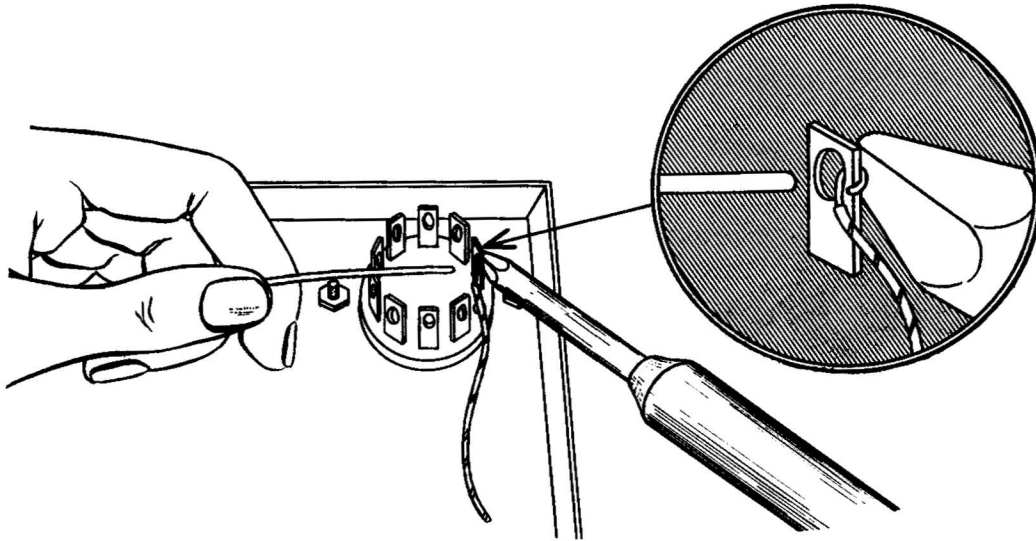

A poor solder joint will usually be indicated by its appearance. The solder will stand up in a blob on top of the connection, with no evidence of flowing out caused by actual "wetting" of the contact. A crystalline or grainy texture on the solder surface, caused by movement of the joint before it solidified is another evidence of a "cold" connection. In either event, reheat the joint until the solder flows smoothly over the entire junction, cooling to a smooth, bright appearance. Photographs in the adjoining picture clearly indicate these two characteristics.

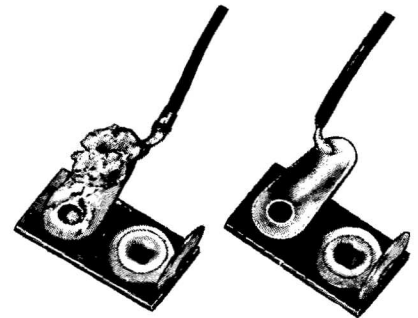

A good, clean, well-tinned soldering iron is also important to obtain consistently perfect connections. For most wiring, a 60 or 100 watt iron, or the equivalent in a soldering gun, is very satisfactory. Smaller irons generally will not heat the connections enough to flow the solder smoothly over the joint and are recommended only for light work, such as on etched circuit boards, etc. Keep the iron tip clean and bright. A pad of steel wool may be used to wipe the tip occasionally during use.

Take these precautions and use reasonable care during assembly of the kit. This will insure the wonderful satisfaction of having the instrument operate perfectly the first time it is turned on.

TOP VIEW

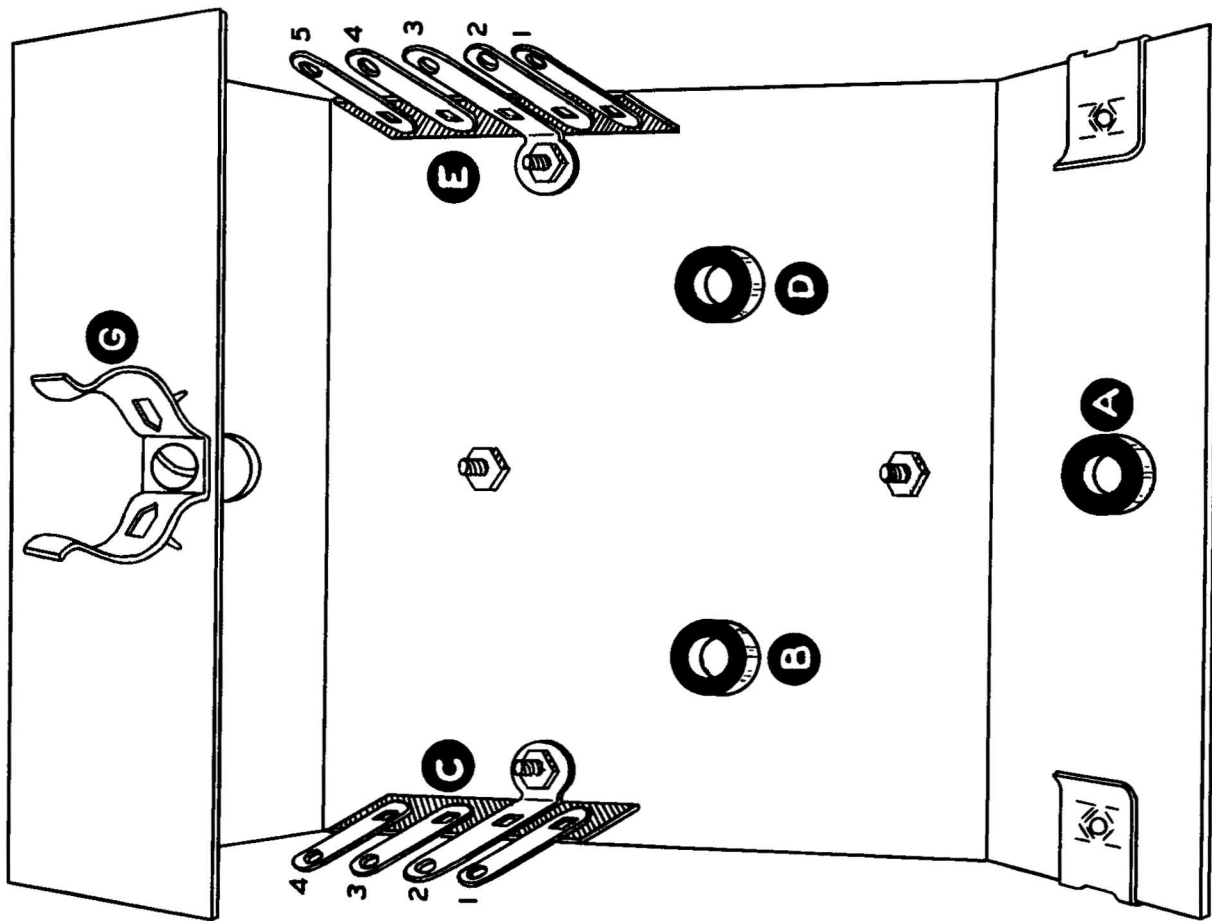

PICTORIAL 1

BOTTOM VIEW

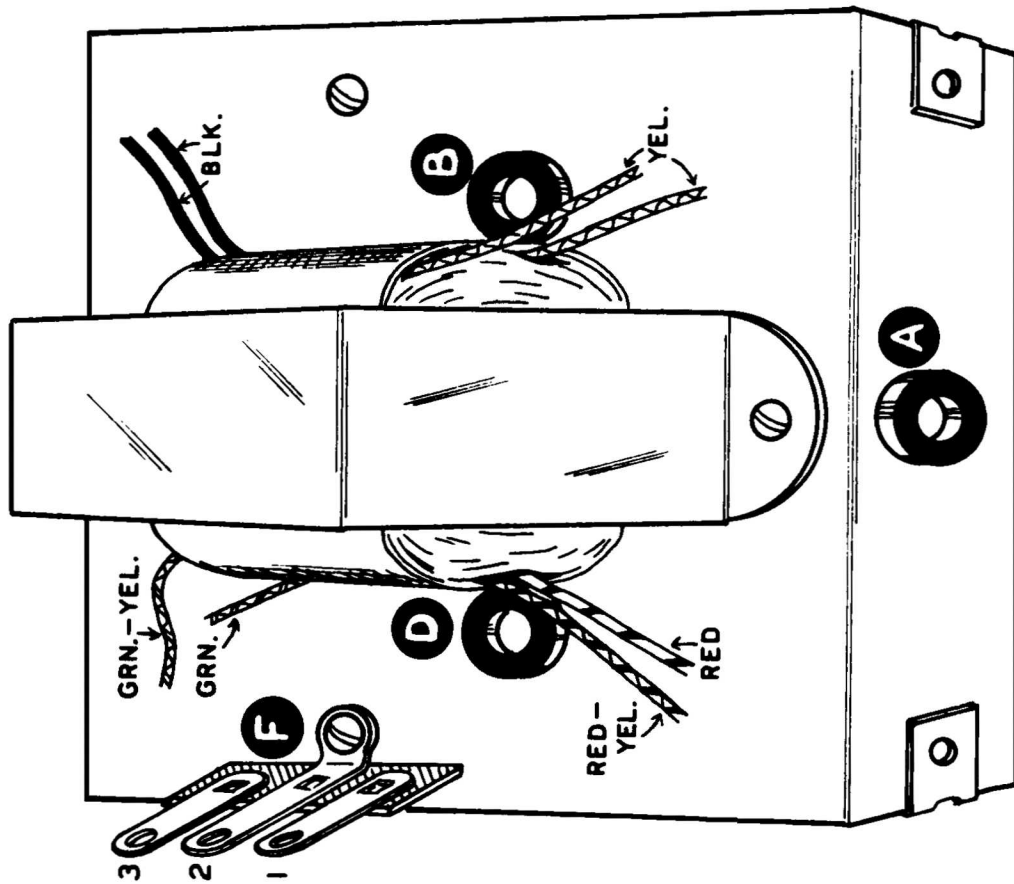

PICTORIAL 2



## STEP-BY-STEP ASSEMBLY INSTRUCTIONS

- ( ) Familiarize yourself with the chassis by comparing it to Pictorial 1. Install the 3/8" rubber grommets at locations A, B and D.
- ( ) Mount the power transformer as shown in Pictorial 2. Use 6-32 screws, lockwashers and nuts. Don't forget to position it properly! The black and the yellow leads are oriented near grommet B.
- ( ) Install a four-lug terminal strip at C, positioning as shown in Pictorial 1. Use 6-32 screw, lockwasher and nut.
- ( ) Mount a five-lug terminal strip E on top of the chassis and a three-lug terminal strip F under the chassis as indicated in Detail 1. Again, use 6-32 hardware (screw, lockwasher and nut).
- ( ) Snap the two speed-nuts on the chassis rear apron, with the flat surface toward the rear. Refer to Figure 1 for details of installation.
- ( ) Install the spring clip on the chassis bracket as indicated in Pictorial 1 at location G.

This concludes the mechanical assembly of the instrument, with the exception of the switch and panel, which will be installed simultaneously at a later time.

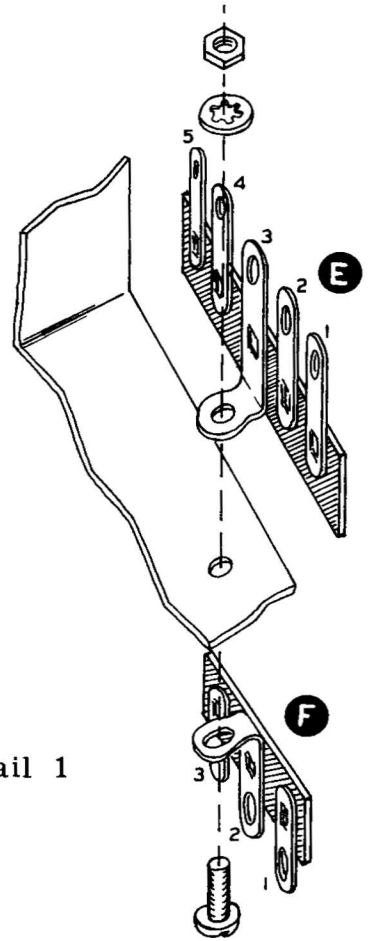

Detail 1

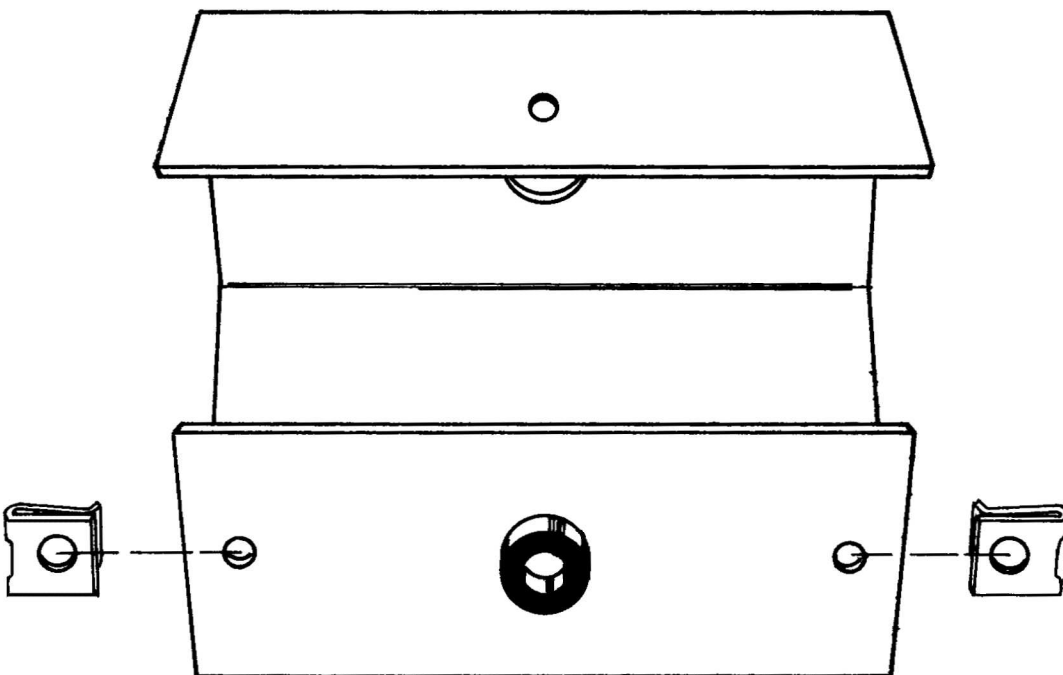

Figure 1



Now would be a good time to plug in the soldering iron and take a breather and check yourself over for any cuts, bruises and so forth which may have accumulated in the preceding steps.

All set? Now let's go!

- ( ) Push the two black and two yellow leads from the transformer up through grommet B. Cut one of the black leads to a length sufficient to reach C4. Strip and tin the lead and connect to C4 (NS). Refer to Pictorial 3.
- ( ) In a similar manner, prepare the other black lead and connect it to C3 (NS). Again, refer to Pictorial 3 for clarification.
- ( ) Dress the two yellow leads across the chassis and connect one of them to E2 (NS). Pictorial 3 shows where.
- ( ) Likewise, connect the remaining yellow lead to E4 (NS).

Turning the chassis over, we see four leads from the transformer still swinging in the breeze. These wires are color-coded and satisfactory operation of the "SHORT-TEST" is dependent upon correct polarity of the transformer windings.

- ( ) Push the red-yellow wire up through grommet D. Cut this wire to a length sufficient to reach E1. Now strip and tin the wire and connect it to E1 (NS). See Pictorials 3 and 4, if you like.
- ( ) Dress the plain red wire down close to the chassis as shown in Pictorial 4 and connect to F2 (NS).
- ( ) Dress the green-yellow wire down to the chassis, over to the terminal strip and connect to F2 (NS).
- ( ) Run the green wire over to F3 and connect (NS).
- ( ) Take a three inch long piece of hookup wire, strip the insulation back about 3/8" on both ends and connect one end to F1 (NS). Push the other end up through grommet D. Looks kind of silly, sticking up there all by itself, doesn't it? Don't worry, it will go to the switch eventually.
- ( ) Pick out a 1500  $\Omega$  (or 1.5 K, if you prefer) resistor (brown-green-red). Connect between F2 (S) (3) and F1 (NS). See Pictorial 4. Press the resistor body close to the terminal strip.
- ( ) Connect a 4700  $\Omega$  (4.7 K) 1-watt resistor (the big one: yellow-violet-red) between F1 (NS) and F3 (NS). Again, refer to Pictorial 4 and position directly above the terminal strip.
- ( ) Install a .02  $\mu$ fd tubular condenser between lugs F1 (S) (4) and F3 (S) (3).

This completes the wiring under the chassis. This particular portion of the circuit is the limiting network which supplies the 60-cycle voltage for the "SHORT-TEST". (See the Circuit Description Section of the manual.)

Shake out any bits of wire and solder, examine for good solder connections and take care of any burned fingers. Ready? We're off!

- ( ) Cut the 8-wire cable to a length of 8 1/2". Strip the outer covering back about 1 1/2" from one end and about 2 1/4" from the other end. See Figure 2 if you're puzzled. DON'T DAMAGE THE INNER WIRES!

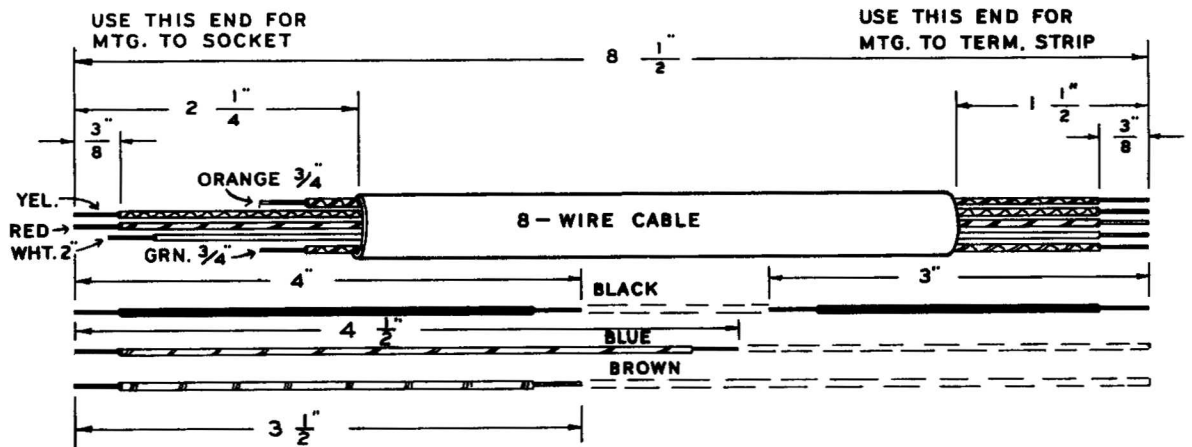
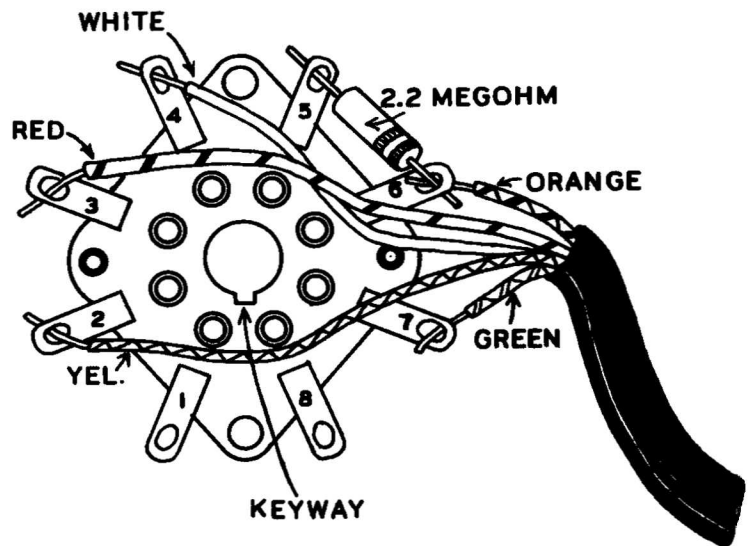

Figure 2

- ( ) Now grasp the black lead in one hand, and the rest of the cable in the other and pull. Simple, wasn't it?
- ( ) Similarly, remove the brown and blue wires. These may take some tugging, but don't give up. They'll come out eventually.
- ( ) Cut and strip the wires to the lengths indicated in Figure 2. For ease of installation, these wires should be tinned. Be sure all the strands of wire are twisted together. A stray strand can cause a minor catastrophe if it happens to touch the wrong place.

Now we wire the tube socket to the cable.

- ( ) Bend all the socket lugs outward, as indicated in Detail 2.
- ( ) The socket lugs are numbered clockwise, starting at the keyway, as shown. Connect a 2.2 megohm resistor (red-red-green) between lug 5 (NS) and lug 6 (NS). Position as shown.
- ( ) Assuming the loose end of the cable was prepared according to a preceding step, connect the orange lead to lug 6 of the socket (S) (2). See Figure 2 and Detail 2.
- ( ) Connect the green wire to lug 7 (S) (1).
- ( ) Run the yellow wire over the back of the socket to lug 2 and solder in place (1).
- ( ) The red wire is next connected to lug 3 (S) (1).
- ( ) Now connect the white wire to lug 4 (S) (1).



Detail 2

Lay the cable and socket assembly and the other wires aside for the present.

( ) Connect a 2.2 megohm resistor (red-red-green) between E1 (NS) and E5 (NS). Use sleeving as shown in Pictorial 3. Push the body of the resistor down close to the terminal strip.

( ) Connect a .1  $\mu$ f condenser between E1 (NS) and E5 (NS). Place as indicated in Pictorial 3.

It is this resistor-capacitor circuit which determines the maximum angle the eye can open.

( ) Connect a .001  $\mu$ f condenser from E5 (NS) to E3 (NS) (use sleeving).

Next the cable is wired to the terminal strip.

( ) Secure the orange lead to E3 (S) (2).

( ) In a similar fashion, connect the green lead to E2 (S) (2).

( ) Likewise, the yellow lead goes to E4 (S) (2).

( ) Connect the white lead to E1 (S) (4).

( ) The red lead now goes to E5 (S) (4).

Now we come to that mechanical and electrical monstrosity known as a switch. Figure 3 shows what it will look like when wired correctly.

( ) Place the switch "H" before you, with the blank hole toward the top, as shown. This is considered number 1. The soldering lugs are numbered clockwise from here.

( ) Connect a 200  $\mu$ f disc condenser between H2 (S) (1) and H3 (NS). Leave enough room to place the coil lug in the slot in H3 (See Figure 3.)

( ) Connect one end of the blue wire, formerly removed from the cable, to H5 (S) (1). This lead should have been cut and stripped in a preceding step. If not, check Figure 2 for dimensions.

( ) One end of the brown wire, similarly prepared, is connected to H6 (NS). Again, leave room for the coil lug.

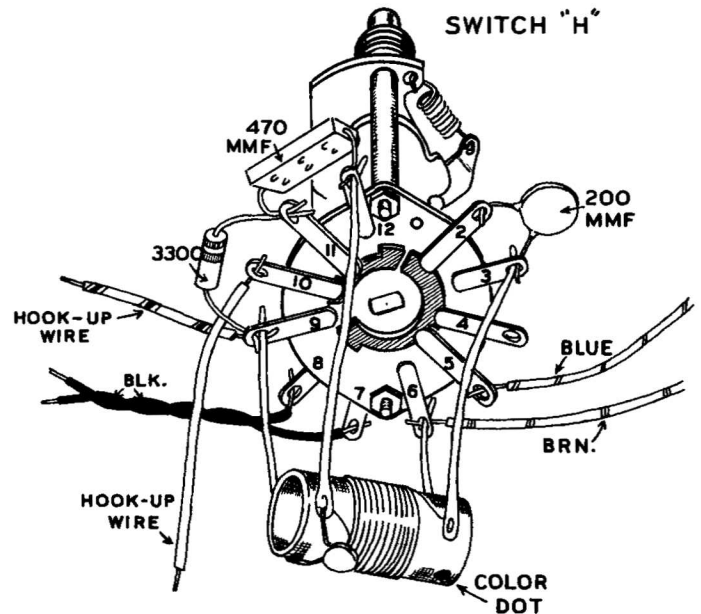

Lugs 7 and 8 are on the FRONT side of the switch wafer.

Figure 3

( ) Connect the 4" black wire, previously prepared from the cable, to H7 (S) (1).

( ) Similarly, connect the 3" black wire to H8 (S) (1). Bring the two leads out the side of the switch and twist together a few times, according to Figure 3.

( ) Strip both ends of a wire 2" long. Connect one end to H9 (NS). Use hookup wire, and be certain to leave room for the coil lug. Leave the other end free.

( ) In the same manner, a wire 4 1/2" long is connected to H10 (S) (1). Leave the other end free.

- ( ) Connect a 3300  $\Omega$  (3.3 K) resistor (orange-orange-red) between H9 (NS) and H11 (NS). Remember, the coil lug goes to H9.
- ( ) A 470  $\mu\mu\text{f}$  condenser is connected between H11 (S) (2) and H12 (NS). This lug (H12) also receives a coil lug.

This completes the switch wiring, except for mounting the coil. This is done in the following manner:

- ( ) Place the coil against the switch with the colored dot as shown in Figure 3. Twist the lugs of the coil slightly, so they penetrate the slots in the switch lugs H3, H6, H9 and H12. Twist only the tip of the coil lug, back about 1/4".
- ( ) Is the color dot oriented in the right place? Good! Now solder H3 (2), H6 (2), H9 (3) and H12 (2).
- ( ) Install the binding posts on the front panel. Use binding post base, insulator bushings, solder lug and finally a 6-32 nut. Include a larger control solder lug between the insulator bushing and the inside of the panel on the right-hand binding post P2 (when viewed from the rear, or chassis side). See Pictorial 4 and Figure 4 for clarification.
- ( ) The switch can now be mounted on the chassis and panel, placing as indicated in Pictorial 5. Use a control lockwasher between the switch and chassis, and a nickel washer between the front panel and the nut. (See Figure 5.) After lining up the chassis and panel sides, tighten the nut securely.

- ( ) Connect the loose end of the wire protruding through grommet D to H4 (S) (1).
- ( ) Connect the shorter wire of the twisted pair (the wire from H8) to C1 (NS). See Pictorial 5.
- ( ) Connect the other wire of the pair to C4 (NS).
- ( ) Place the stripped end of the line cord through grommet A and tie a knot about 5" from the end for strain relief.
- ( ) Dress the line cord down into the back corner of the chassis, as shown in Pictorial 3, and connect one lead to C1 (S) (2).
- ( ) Connect the other lead to C3 (S) (2).

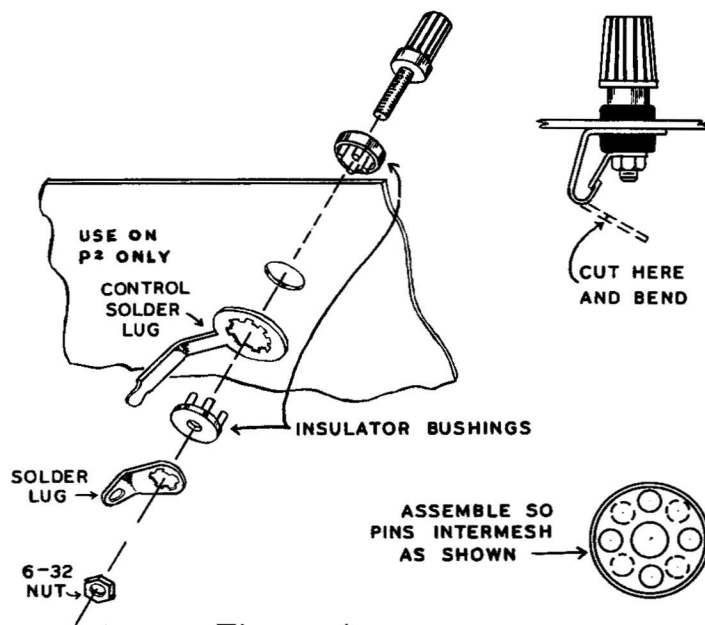
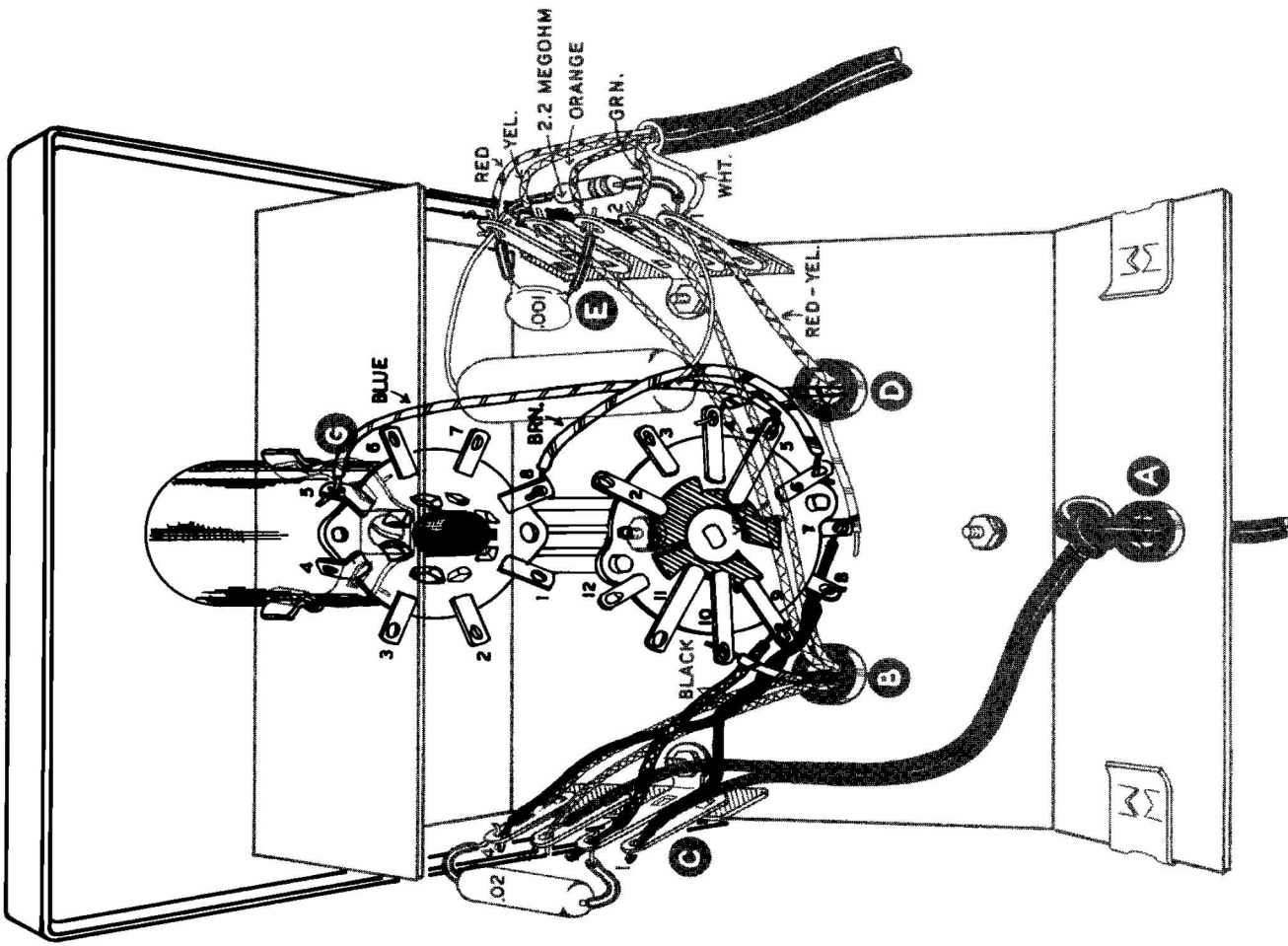
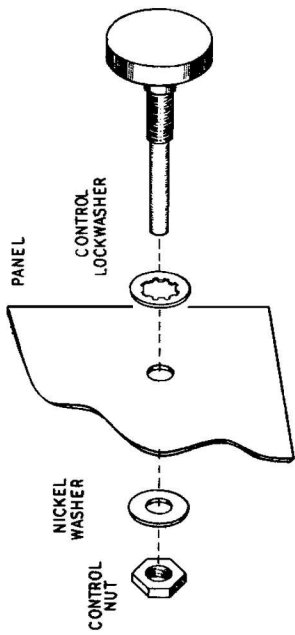

Figure 4

- ( ) Run the short lead from H9 over to C2 and connect at that point. Do not solder yet.
- ( ) Connect a .02  $\mu\text{fd}$  condenser between C2 (S) (2) and C4 (S) (3). Use sleeving, and position the body of the condenser directly above the terminal strip, as shown in Pictorial 3.
- ( ) The long lead from H10 goes down through grommet B and is connected to the left-hand binding post solder lug P1 (S) (1). See Pictorials 4 and 5.
- ( ) The other binding post should have the large solder lug between the insulator and the panel. Bend this lug back over the small one and solder. Figure 4 demonstrates this step.



PICTORIAL 5



HOW TO MOUNT CONTROLS & SWITCHES.

Figure 5

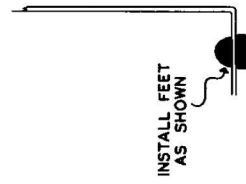

Figure 6

We're almost finished now.

Place the socket on the tube, being careful not to exert too much pressure in one spot. The tube will go in quite hard the first couple of times, so don't give up yet. **BE SURE THE SOCKET IS ON THE TUBE PINS AS FAR AS IT WILL GO!** Unless the socket and tube base are in contact, an embarrassing situation may exist, where the pins will touch the metal cabinet when the unit is assembled, resulting in a little hair-pulling.

- ( ) Now bend socket lugs 4 and 5 on over toward the front side of the socket. See Pictorial 5. This eliminates any possibility of the lugs touching the cabinet when assembled.
- ( ) Snap the tube in its clip and push forward until the top bubble protrudes through the front panel. The keyway should be pointing down. The tube envelope will not go through the hole, so stop pushing when it won't go any farther forward.
- ( ) Dress the blue lead from the switch lug 5 as shown in Pictorial 5 and connect to the tube socket lug 5 (S) (2).
- ( ) In a similar manner, the brown lead is connected to lug 8 (S) (1).

Now we're on the home stretch. Next the cabinet is prepared.

- ( ) Install the rubber feet in the four holes on the cabinet bottom, as shown in Figure 6 on Page 13. Moistening the feet with water will facilitate insertion.
- ( ) The handle is assembled to the cabinet top with #10 screws.
- ( ) Assemble the test leads as shown in Figure 7.



Figure 7

- ( ) Screw the binding post caps on the appropriate bases: black on the grounded side, red on the ungrounded side.
- ( ) Install the knob on the switch shaft, and position it properly. The knob should return automatically to the "check" position from the "test" position, in both directions.
- ( ) Place the chassis in the cabinet, but don't place the screws in the back yet.

#### TESTING THE INSTRUMENT

Will it work? It will if assembly instructions have been followed carefully.

Plug the unit into a source of 105-125 volt, 50-60 cycle AC only! The instrument will not operate on DC, and due to high currents which will flow, a burned-out power transformer may result.

Turn the switch to "OPEN-CHECK" position, and allow the instrument to warm up. The eye should be completely closed. Plug the test leads in, and short the clips together. Turn the switch down into the "TEST" position. The eye should remain closed. Next "un-short" the test leads, and the eye should open.

Now turn the switch over to the "SHORT-CHECK" position. The eye should be open in this position. Short the leads together and turn the switch on over to the "TEST" position. If all is functioning as it should, the eye shouldn't budge the least bit. Unshort the leads and again switch to the "TEST" position. This time the eye should close completely.

This completes the testing of the instrument. Fasten the CAPACI-TESTER in its cabinet with 6-32 x 1/2" screws.



## IN CASE OF DIFFICULTY

If, after careful construction procedures have been followed, the instrument fails to operate as indicated, check the following:

1. Check wiring carefully, step-by-step. If possible have a friend assist you in this as an error can be consistently overlooked.
2. Inspect for signs of definite malfunction, such as heater not lit, resistors charred or discolored, overheated transformer, etc.
3. Check voltages at the tube socket.

TUBE	Pin 1	Pin 2	Pin 3	Pin 4	Pin 5	Pin 6	Pin 7	Pin 8
1629	NC	12.6 AC to Pin 7	530 AC -250	540 AC	-8	0	12.6 AC to Pin 2	0

Sw. in OPEN-CHECK position.

Measured with a VTVM (Heath V-7A or equivalent) from pin to ground, unless indicated.

If the foregoing information does not help you in locating the source of difficulty, write the Heath Company and describe the difficulty in as much detail as you can, including voltage measurements if possible. Be sure to give the model and name of the instrument, CT-1 CAPACI-TESTER. Prompt attention will be given to your inquiry.

## OPERATION

To operate the CAPACI-TESTER is a simple matter. Switch to the OPEN-CHECK or SHORT-CHECK position (whichever test you desire to perform first) and allow the instrument time to warm up. Clip the test leads across the capacitor to be checked, then switch to the TEST position. If the eye is open in this position, replace the capacitor. If the eye is closed, then make the other test. If, in this case, the eye is open, replace the capacitor. If the eye is closed, the capacitor may be considered good. If the eye flutters in either position when the capacitor is tapped sharply, the capacitor is intermittent and should be replaced. Before testing, however, make sure the power is off in the equipment being tested. Failure to do so may result in getting a healthy "kick", which could be dangerous. Play it safe and UNPLUG the unit being worked on.

This instrument, as well as anything else, has limitations. If the capacitor under test is less than 100  $\mu\mu\text{fd}$  capacity, it should be disconnected from the circuit for testing, just as should a capacitor which is shunted by less than about 30  $\Omega$ . Under these conditions (low value capacity and low shunt resistance) the eye will not close completely. This could be misleading in the SHORT-TEST position, so a CHECK position is provided, which indicates what a shorted capacitor causes the eye to do. With a shunt resistance of less than about 5 K, the eye will not close completely. As the shunt R. becomes even smaller, less of an indication is obtained. If the eye has any tendency whatsoever to close, however, the capacitor is not shorted. If, on the other hand, no change is apparent when switching between SHORT-CHECK and TEST positions, the capacitor is shorted. The instrument will not check accurately capacitors which are shunted by an inductance, if the reactance of the inductance is less than about 30  $\Omega$  at the test frequency. This means 60 cycles for the short test, and 19 megacycles for the open test.

This instrument will check opens or shorts in all types of capacitors except electrolytics which may be checked for opens only. Inherent leakage and low reactance at test frequencies result in erroneous indications in the short position.

Operated within its limitations, the CAPACI-TESTER should prove to be an invaluable aid in locating the general run of capacitor troubles: open, shorts and intermittents.

## BIBLIOGRAPHY

For those of you who are interested in finding out more about in-circuit capacitor testers, as well as the principles utilized in the CT-1, here are some articles which should help you.

RADIO AMATEUR'S HANDBOOK, 29th Edition. American Radio Relay League. Page 40.  
RADIO ENGINEERING HANDBOOK, 1st Edition. McGraw-Hill. Page 154.

And some magazine articles:

RADIO-ELECTRONICS, June 1955, Page 72.  
RADIO-ELECTRONICS, September 1955, Page 44.  
RADIO AND TV NEWS, September 1955, Page 118.

## REPLACEMENTS

Material supplied with Heathkits has been carefully selected to meet design requirements and ordinarily will fulfill its function without difficulty. Occasionally improper instrument operation can be traced to a faulty tube or component. Should inspection reveal the necessity for replacement, write to the Heath Company and supply all of the following information:

- A. Thoroughly identify the part in question by using the part number and description found in the manual parts list.
- B. Identify the type and model number of kit in which it is used.
- C. Mention the order number and date of purchase.
- D. Describe the nature of defect or reason for requesting replacement.

The Heath Company will promptly supply the necessary replacement. Please do not return the original component until specifically requested to do so. Do not dismantle the component in question as this will void the guarantee. If tubes are to be returned, pack them carefully to prevent breakage in shipment as broken tubes are not eligible for replacement. This replacement policy does not cover the free replacement of parts that may have been broken or damaged through carelessness on the part of the kit builder.

## SERVICE

If, after applying the information contained in this manual and your best efforts on the unit, you are still unable to obtain proper performance from the Instrument, it is suggested that you take advantage of the technical facilities which the Heath Company makes available to its customers.

The Technical Consultation Department is maintained for the purpose of providing Heath customers with a personalized technical consultation service; this service is available to you without charge. The technical consultants are thoroughly familiar with all details of the Instrument and can usually localize the trouble from a suitable description of the difficulty encountered. It is, of course, necessary that you provide full and complete information concerning your problem when writing to the Technical Consultation Department for assistance. For instance, clearly identify the kit involved, giving the purchase date and, if possible, the invoice number; describe in detail the difficulty that you have encountered; state what you have attempted to do to rectify the trouble, what results have been achieved, and include any information or clues that you feel could possibly be of value to the consultant who handles your problem. Failure to provide complete descriptive details may lead to incorrect assumptions on the part of the consultant and needless delay in the solution to your problem. Quite frequently, when the information given the consultant is complete, concise and reliable, a diagnosis of the difficulty can be made with confidence and specific instructions given for its correction. If replacement of a component is involved in the correction, the component will be shipped to you, subject to the terms and conditions of the Warranty.

The Factory Service facilities are also available to you, in case you are not familiar enough with electronics to provide our consultants with sufficient information on which to base a diagnosis of your difficulty, or in the event that you prefer to have the difficulty corrected in this manner. You may return the complete Instrument to the Heath Company for inspection and necessary repairs and adjustments. You will be charged a fixed fee of \$3.00, plus the price of any additional parts or material required. However, if the Instrument is returned within the Warranty period, parts charges will be governed by the terms of the Warranty. State the date of purchase and give invoice number, if possible.

Local Service by Authorized Heathkit Dealers is also available and often will be your fastest, most efficient method of obtaining service for your Heathkits. Although you may find charges for local service somewhat higher than those listed in Heathkit manuals (for factory service), the amount of increase is usually offset by the transportation charges you would pay if you elected to return your kit to the Heath Company.

Heathkit dealers will honor the regular 90 day Heathkit Parts Warranty on all kits, whether purchased through a dealer or directly from Heath Company. It will be necessary that you verify the purchase date of your kit by presenting your copy of the Heath Company invoice to the authorized dealer involved.

Under the conditions specified in the Warranty, replacement parts are supplied without charge; however, if your local dealer assists you in locating a defective part (or parts) in your Heathkit, or installs a replacement part for you, he may charge you for this service.

Heathkits purchased locally and returned to Heath Company for service must be accompanied by your copy of the dated sales receipt from your authorized Heathkit dealer in order to be eligible for parts replacement under the terms of the Warranty.

**THESE SERVICE POLICIES APPLY ONLY TO COMPLETED INSTRUMENTS CONSTRUCTED IN ACCORDANCE WITH THE INSTRUCTIONS AS STATED IN THE MANUAL.** Instruments that are not entirely completed or instruments that are modified in design will not be accepted for repair. Instruments showing evidence of acid core solder or paste fluxes will be returned **NOT** repaired.

For information regarding modifications of Heathkits for special applications, it is suggested that you refer to any one or more of the many publications that are available on all phases of electronics. They can be obtained at or through your local library, as well as at most electronic outlet stores. Although the Heath Company welcomes all comments and suggestions, it would be impossible to design, test, evaluate and assume responsibility for proposed circuit changes for specific purposes. Therefore, such modifications must be made at the discretion of the kit builder, according to information which will be much more readily available from some local source.

#### SHIPPING INSTRUCTIONS

Before returning a unit for service, be sure that all parts are securely mounted.

**ATTACH A TAG TO THE INSTRUMENT GIVING  
NAME, ADDRESS AND TROUBLE EXPERIENCED.**

Pack in a rugged container, preferably wood, using at least three inches of shredded newspaper or excelsior on all sides. Ship the complete kit including test leads, tube, cabinet, etc., to enable the service department to do a complete job. **DO NOT SHIP IN THE ORIGINAL KIT CARTON AS THIS CARTON IS NOT CONSIDERED ADEQUATE FOR SAFE SHIPMENT OF THE COMPLETED INSTRUMENT.** Ship by prepaid express if possible. Return shipment will be made by express collect. Note that a carrier cannot be held liable for damage in transit if packing, in HIS OPINION, is insufficient.

**PARTS LIST**

<u>PART No.</u>	<u>PARTS Per Kit</u>	<u>DESCRIPTION</u>	<u>PART No.</u>	<u>PARTS Per Kit</u>	<u>DESCRIPTION</u>
<b>Resistors</b>			<b>Terminal Strips-Sockets</b>		
1-11	1	1.5 K $\Omega$ 1/2 watt	431-10	1	3-lug terminal strip
1-14	1	3.3 K $\Omega$ 1/2 watt	431-11	1	5-lug terminal strip
1-37	2	2.2 megohm 1/2 watt	431-12	1	4-lug terminal strip
1-24A	1	4.7 K $\Omega$ 1 watt	434-31	1	Wafer octal socket
<b>Condensers</b>			<b>Hardware</b>		
20-40	1	470 $\mu\mu$ fd mica, 5%	250-9	5	6-32 x 3/8" RHMS
21-14	1	.001 $\mu$ fd ceramic	250-10	2	6-32 x 1/2" screw
21-21	1	200 $\mu\mu$ fd ceramic	250-83	2	Handle screw, #10 sheet metal
23-8	2	.02 $\mu$ fd paper, 600 volt	252-3	7	6-32 nut
23-11	1	.1 $\mu$ fd paper, 600 volt	252-7	1	Control nut
<b>Transformers-Coils</b>			252-22	2	Speed nut, 6-32
40-96	1	Oscillator coil assembly	253-10	1	Control nickel washer
54-7	1	Power transformer	254-1	5	#6 lockwasher
<b>Switch</b>			254-4	1	Control lockwasher
63-130	1	5-position rotary switch	259-1	2	#6 solder lug
<b>Binding Post-Test Lead Parts</b>			259-10	1	Control solder lug
70-5	1	Banana plug sleeve, black	<b>Sheet Metal Parts</b>		
70-6	1	Banana plug sleeve, red	90-17	1	Cabinet
100-M16R	1	Binding post cap, red	200M119	1	Chassis
100-M16B	1	Binding post cap, black	203-113F153	1	Front panel
260-1	2	Alligator clip	<b>Miscellaneous</b>		
427-2	2	Binding post base	73-1	3	3/8" x 9/32" rubber grommet
438-13	2	Banana plug assembly	75-17	4	Insulator bushing
<b>Wire-Cable</b>			208-2	1	Mounting clip
89-1	1	Line cord	211-4	1	Cabinet handle
347-1	1	length 8-conductor cable	261-1	4	Rubber feet
344-1	1	length hookup wire	411-30	1	1629 tube
341-1	1	length Test lead wire, black	462-24	1	Knob
341-2	1	length Test lead wire, red	346-1	1	length sleeving
			595-161	1	Manual

## WARRANTY

Heath Company warrants that for a period of three months from the date of shipment, all Heathkit parts shall be free of defects in materials and workmanship under normal use and service and that in fulfillment of any breach of such warranty, Heath Company shall replace such defective parts upon the return of the same to its factory. The foregoing warranty shall apply only to the original buyer, and is and shall be in lieu of all other warranties, whether express or implied and of all other obligations or liabilities on the part of Heath Company and in no event shall Heath Company be liable for any anticipated profits, consequential damages, loss of time or other losses incurred by the buyer in connection with the purchase, assembly or operation of Heathkits or components thereof. No replacement shall be made of parts damaged by the buyer in the course of handling or assembling Heathkit equipment.

**NOTE:** The foregoing warranty is completely void and we will not replace, repair or service instruments or parts thereof in which acid core solder or paste fluxes have been used.

HEATH COMPANY

All prices are subject to change without notice. The Heath Company reserves the right to discontinue instruments and to change specifications at any time without incurring any obligation to incorporate new features in instruments previously sold.

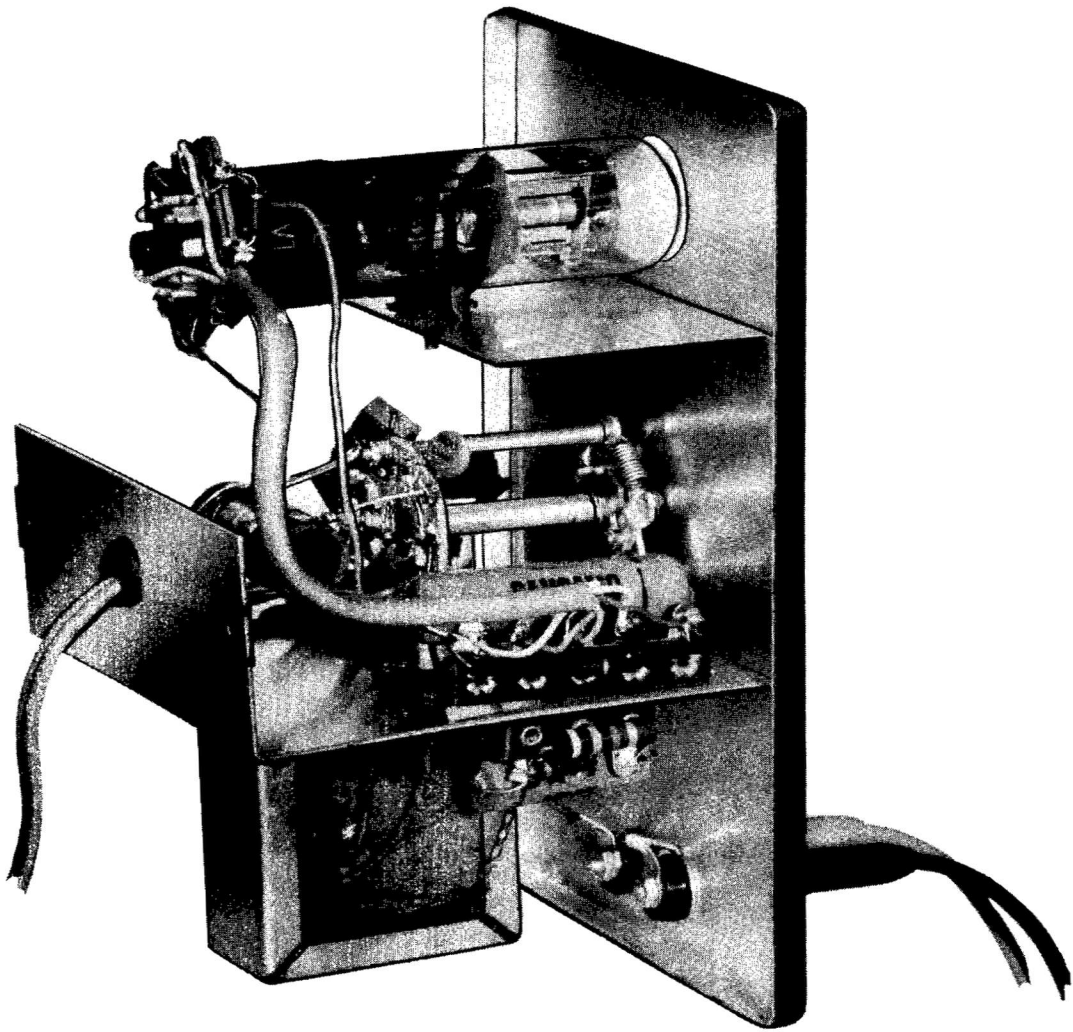

## HELPFUL KIT BUILDING INFORMATION

Before attempting actual kit construction read the construction manual through thoroughly to familiarize yourself with the general procedure. Note the relative location of pictorials and pictorial inserts in respect to the progress of the assembly procedure outlined.

This information is offered primarily for the convenience of novice kit builders and will be of definite assistance to those lacking thorough knowledge of good construction practices. Even the advanced electronics enthusiast may benefit by a brief review of this material before proceeding with kit construction. In the majority of cases, failure to observe basic instruction fundamentals is responsible for inability to obtain desired level of performance.

### RECOMMENDED TOOLS

The successful construction of Heathkits does not require the use of specialized equipment and only basic tools are required. A good quality electric soldering iron is essential. The preferred size would be a 100 watt iron with a small tip. The use of long nose pliers and diagonal or side cutting pliers is recommended. A small screw driver will prove adequate and several additional assorted screw drivers will be helpful. Be sure to obtain a good supply of rosin core type radio solder. Never use separate fluxes, paste or acid solder in electronic work.

### ASSEMBLY

In the actual mechanical assembly of components to the chassis and panel, it is important that the procedure shown in the manual be carefully followed. Make sure that tube sockets are properly mounted in respect to keyway or pin numbering location. The same applies to transformer mountings so that the correct transformer color coded wires will be available at the proper chassis opening.

Make it a standard practice to use lock washers under all 6-32 and 8-32 nuts. The only exception being in the use of solder lugs—the necessary locking feature is already incorporated in the design of the solder lugs. A control lock washer should always be used between the control and the chassis to prevent undesirable rotation in the panel. To improve instrument appearance and to prevent possible panel marring use a control flat nickel washer under each control nut.

When installing binding posts that require the use of fiber insulating washers, it is good practice to slip the shoulder washer over the binding post mounting stud before installing the mounting stud in the panel hole provided. Next, install a flat fiber washer and a solder lug under the mounting nut. Be sure that the shoulder washer is properly centered in the panel to prevent possible shorting of the binding post.

### WIRING

When following wiring procedure make the leads as short and direct as possible. In filament wiring requiring the use of a twisted pair of wires allow sufficient slack in the wiring that will permit the twisted pair to be pushed against the chassis as closely as possible thereby affording relative isolation from adjacent parts and wiring.

































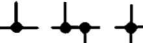

When removing insulation from the end of hookup wire, it is seldom necessary to expose more than a quarter inch of the wire. Excessive insulation removal may cause a short circuit condition in respect to nearby wiring or terminals. In some instances, transformer leads of solid copper will have a brown baked enamel coating. After the transformer leads have been trimmed to a suitable length, it is necessary to scrape the enamel coating in order to expose the bright copper wire before making a terminal or soldered connection.

In mounting parts such as resistors or condensers, trim off all excess lead lengths so that the parts may be installed in a direct point-to-point manner. When necessary use spaghetti or insulated sleeving over exposed wires that might short to nearby wiring.

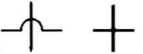
It is urgently recommended that the wiring dress and parts layout as shown in the construction manual be faithfully followed. In every instance, the desirability of this arrangement was carefully determined through the construction of a series of laboratory models.

### SOLDERING

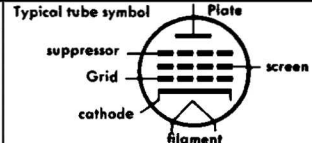
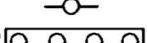
Much of the performance of the kit instrument, particularly in respect to accuracy and stability, depends upon the degree of workmanship used in making soldered connections. Proper soldered connections are not at all difficult to make but it would be advisable to observe a few precautions. First of all before a connection is to be soldered, the connection itself should be clean and mechanically strong. Do not depend on solder alone to hold a connection together. The tip of the soldering iron should be bright, clean and free of excess solder. Use enough heat to thoroughly flow the solder smoothly into the joint. Avoid excessive use of solder and do not allow a flux flooding condition to occur which could conceivably cause a leakage path between adjacent terminals on switch assemblies and tube sockets. This is particularly important in instruments such as the VTVM, oscilloscope and generator kits. Excessive heat will also burn or damage the insulating material used in the manufacture of switch assemblies. Be sure to use only good quality rosin core radio type solder.

Antenna General 	Resistor General 	Neon Bulb 	Receptacle two-conductor 
Loop 	Resistor Tapped 	Illuminating Lamp 	Battery 
Ground 	Resistor Variable 	Switch Single pole Single throw 	Fuse 
Inductor General 	Potentiometer 	Switch double pole single throw 	Piezoelectric Crystal 
Air core Transformer General 	Thermistor 	Switch Triple pole Double throw 	1000 = <b>K</b>
Adjustable Powdered Iron Core 	Jack two conductor 	Switch Multipoint or Rotary 	1,000,000 = <b>M</b>
Magnetic Core Variable Coupling 	Jack three conductor 	Speaker 	OHM = $\Omega$
Iron Core Transformer 	Wires connected 	Rectifier 	Microfarad = <b>MF</b>
Capacitor General 	Wires Crossing but not connected 	Microphone 	Micro Microfarad = <b>MMF</b>
Capacitor Electrolytic 	A. Ammeter V. Voltmeter 	Typical tube symbol 	Binding post Terminal strip 
Capacitor Variable 	G. Galvanometer MA. Milliammeter uA. Microammeter, etc. 		Wiring between like letters is understood $\begin{matrix} \downarrow \downarrow \downarrow \downarrow \\ \rightarrow X \ Y \ X \ Y \ X \\ \rightarrow Y \end{matrix}$

Courtesy of I. R. E.

# **HEATH COMPANY**

*A Subsidiary of Daystrom Inc.*

**THE WORLD'S FINEST ELECTRONIC EQUIPMENT IN KIT FORM**

**BENTON HARBOR, MICHIGAN**

Copyright 1959  
Heath Company  
Benton Harbor, Michigan

4/20/59

Printed in U. S. A.