

PRICE 17/6



**Assembling
and
Using Your...**



**HIGH FIDELITY
STEREO AMPLIFIER**

MODEL S-99

DAYSTROM LIMITED

A Subsidiary of the Daystrom Group,
Manufacturers of the world's finest
Electronic Equipment in Kit Form.

GLOUCESTER, ENGLAND

COMPONENT IDENTIFICATION CHART

THESE COMPONENTS ARE NOT NECESSARILY IDENTICAL TO THE PARTS IN THIS KIT BUT ARE SUFFICIENTLY CLEAR TO HELP YOU IDENTIFY COMPONENTS IN GENERAL USE.

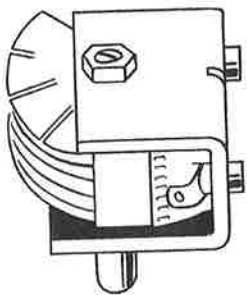

VARIABLE CAPACITOR.

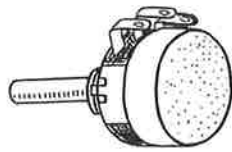

POTENTIOMETER.

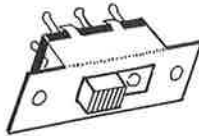

SLIDE SWITCH.



ROTARY SWITCH.

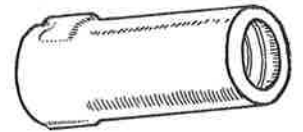

VALVE SCREEN.

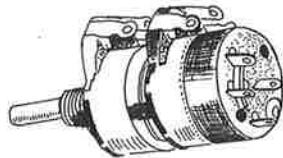

CONTROL POTENTIOMETER (DUAL WITH SWITCH.) OR



DUAL WITHOUT SWITCH.

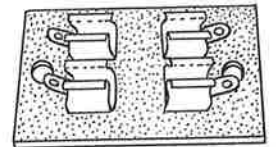

FUSE HOLDER.

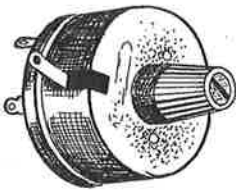

CONTROL POTENTIOMETER.



RUBBER FEET.



NEON INDICATOR.

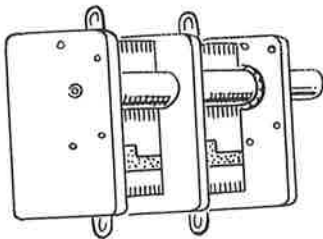

GANGED VARIABLE CAPACITOR



GROMMETS, RUBBER

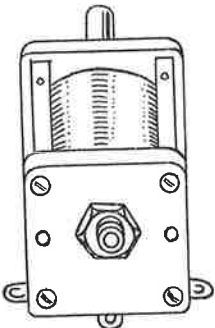

TRANSMITTER CAPACITOR

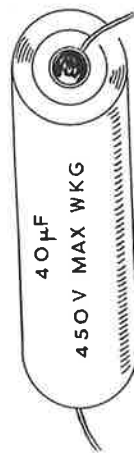

ELECTROLYTIC CAPACITORS.

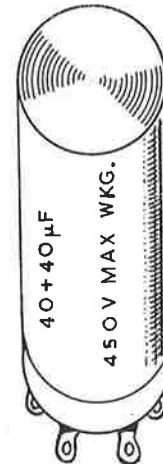

FUSE HOLDER.

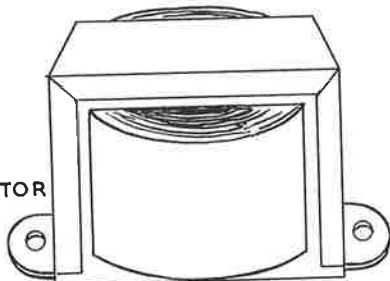

TRANSFORMER OR LF CHOKE.



LAMP HOLDER.



COAXIAL SOCKET.



6-BA SOLDER TAG.

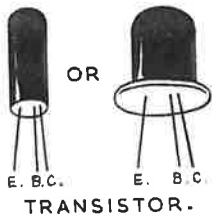

E. B. C. TRANSISTOR.



SPEEDNUT.



SPRING CLIP.



TRANSISTOR SOCKET.

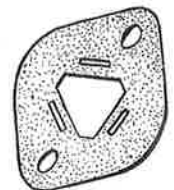

MOUNTING PLATE FOR ELECTROLYTIC CAPACITOR

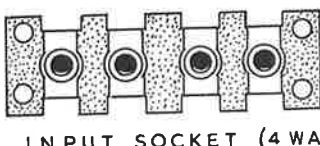

INPUT SOCKET (4 WAY)



INPUT SOCKET.



SOCKET, WANDER PLUG.



MOUNTING PILLAR.

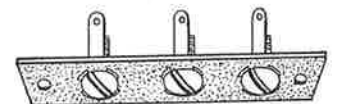

TERMINALS (3 WAY).

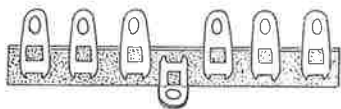

TAG STRIP (6 WAY.)

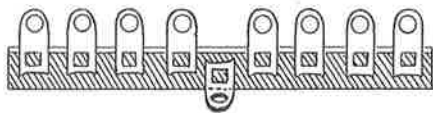

TAG STRIP. (8 WAY)

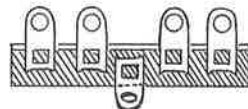

TAG STRIP. (4 WAY)

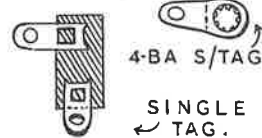

4-BA S/TAG
SINGLE TAG.

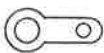

B.A. SOLDER TAG.



B.A. FLAT WASHER.



FIBRE WASHER.

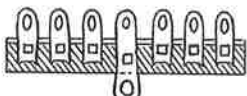

6-WAY TAG-STRIP WITH EARTH.



SOCKET.

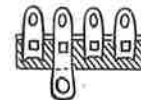

4-WAY T/S WITH EARTH.



PLASTIC CLIP (LARGE)

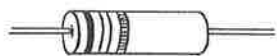

1/2 WATT RESISTOR.



220PF
SILVER MICA CAPACITOR.



CHOKE



1- WATT RESISTOR.

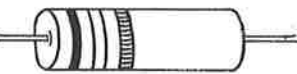

2- WATT RESISTOR.



2000
DISC CERAMIC CAPACITOR.

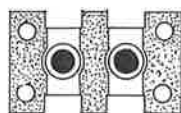

SOCKET (2 WAY)



FEED THROUGH INSULATOR



COAXIAL SOCKET.

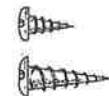

SELF-TAPPING SCREWS.



RESISTOR METAL FILM.

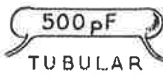

500 pF
TUBULAR CERAMIC CAPACITOR.

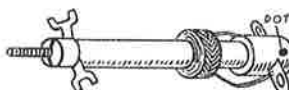

OSC. COIL



CONTROL NUT & WASHER



SKIRTED V/HOLDER



PARASITIC CHOKE

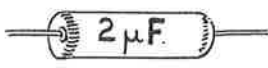

2 μF
2 μF PAPER CAPACITOR.



6-BA



4-BA



2-BA



RF CHOKE OR COIL



MICA CAPACITOR

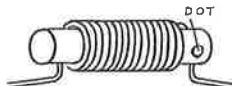

FILTER CHOKE OR COIL

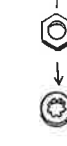

SCREENED WIRE.



INSULATED WIRE.



3 CORED INSULATED CABLE.



SLEEVING.



OSCILLATOR COIL.



SPILL.



"NOVAL" V/HOLDER.

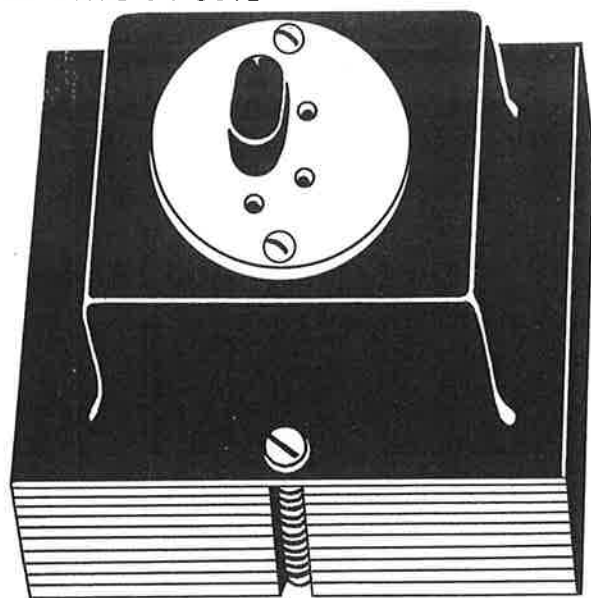

MAINS TRANSFORMER.



I.F. TRANSFORMER.



INTERNATIONAL 'OCTAL'.

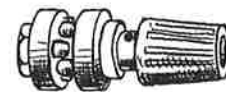

TERMINAL (RED OR BLACK)

IMPORTANT NOTICE

Dear Customer,

To conform to European mains wiring standard we have added to this kit:-

1 off 3 core mains cable (some models 2 core)

1 off strain relief grommet

Identify and use the 3 wire mains cable having wires coloured BLUE, BROWN, GREEN/YELLOW, or in the 2 wire cable BLUE AND BROWN.

When wiring mains cable connect as follows:-

- 1) Connect GREEN/YELLOW to the hole or tag marked Green.
- 2) Connect BLUE wire to the hole or tag marked RIBBED.
- 3) Connect the Brown wire to the hole marked smooth. Of course with 2 core there will be no earth.

Then connect to your mains plug as per instructions on the plug.

HEATH PARTS PRICE LIST
ET -3100 ECL 08

09/06/79

PAGE 1 OF 1

KEEP THIS PARTS LIST WITH YOUR MANUAL AND USE THE PRICES SHOWN BELOW WHEN ORDERING PARTS. THESE PRICES ARE SUBJECT TO CHANGE WITHOUT NOTICE.

THE PRICES SHOWN ON THE "HEATH PARTS PRICE LIST" APPLY ONLY ON PURCHASES FROM THE HEATH COMPANY WHERE SHIPMENT IS TO A U.S.A. DESTINATION. ADD 10% (MINIMUM 25 CENTS) TO THE PRICE WHEN ORDERING (MICHIGAN RESIDENTS ADD 4% SALES TAX) TO COVER INSURANCE, POSTAGE, AND HANDLING. OUTSIDE THE U.S.A., PARTS AND SERVICE ARE AVAILABLE FROM YOUR LOCAL HEATHKIT SOURCE AND WILL REFLECT ADDITIONAL TRANSPORTATION, TAXES, DUTIES, AND RATES OF EXCHANGE.

ADDITIONAL 3 FT ROLLS OF SOLDER, #331-6, CAN BE ORDERED FOR 25 CENTS EACH.

PART NUMBER	PRICE	*	PART NUMBER	PRICE	*	PART NUMBER	PRICE	*	PART NUMBER	PRICE	*
6-	102-12	.25	*	344-	21	.05@	*				*
6-	221-12	.25	*	344-	50	.05@	*				*
6-	222-12	.25	*	344-	51	.05@	*				*
6-	273-12	.25	*	344-	52	.05@	*				*
6-	332-12	.25	*	344-	53	.05@	*				*
6-	470-12	.25	*	344-	54	.05@	*				*
6-	472-12	.25	*	344-	55	.05@	*				*
6-	479-12	.25	*	344-	56	.05@	*				*
6-	561-12	.25	*	346-	1	.10@	*				*
6-	563-12	.25	*	352-	13	.25	*				*
10-	391	.75	*	390-	1135	.15	*				*
10-	1053	1.00	*	390-	1136	.85	*				*
10-	1054	1.10	*	390-	1255	.15	*				*
10-	1055	1.10	*	412-	15	.30	*				*
12-	146	3.50	*	412-	83	3.15	*				*
25-	163	.30	*	415-	15	.45	*				*
25-	865	.45	*	417-	235	.55	*				*
25-	876	1.40	*	417-	801	.45	*				*
25-	74	.30	*	417-	818	1.30	*				*
54-	892	8.00	*	417-	819	1.50	*				*
56-	56	.55	*	421-	26	.50	*				*
56-	620	.60	*	431-	86	.15	*				*
57-	65	.40	*	432-	874	1.00	*				*
60-	78	.85	*	432-	875	8.40	*				*
60-	607	1.00	*	434-	230	.40	*				*
73-	92	.25	*	442-	22	2.00	*				*
75-	52	.05	*	455-	50	.15	*				*
75-	724	.20	*	462-	399	.80	*				*
85-	1596- 2	13.65	*	490-	5	.25	*				*
89-	49	1.05	*	490-	111	.15	*				*
92-	611	2.60	*								*
92-	612	3.90	*								*
25-	15	.35	*								*
2500-	4	.05	*								*
2500-	32	.05	*								*
2500-	116	.05	*								*
2500-	163	.05	*								*
2500-	559	.10	*								*
2500-	592	.05	*								*
2500-	1137	.15	*								*
252-	2	.05	*								*
252-	3	.05	*								*
252-	7	.05	*								*
252-	170	.10	*								*
253-	10	.05	*								*
254-	1	.05	*								*
254-	4	.05	*								*
254-	9	.05	*								*
260-	56	.15	*								*
261-	34	.20	*								*

***** WRITE HEATH COMPANY FOR PRICE INFORMATION.
@ PRICE PER FOOT.

IMPORTANT INFORMATION regarding the resistors in your kit.

Carbon film resistors have been supplied with your kit in place of many of the carbon composition resistors previously used. Although carbon composition resistors may still be illustrated in your Manual, the values, color codes and installation of these components remain the same.

However, there are three important facts you should remember:

- 1. **All carbon film resistors supplied with your kit have a tolerance of 5%.** You can use them in any assembly step which calls for 5% or 10% tolerance resistors.
- 2. Carbon film resistors have a greater heat dissipating ability for their physical size than carbon composition resistors.
- 3. **1/2-watt carbon film resistors may nearly be the same physical size as 1/4-watt carbon film resistors.** However, side-by-side comparison will identify the larger wattage resistor as having the slightly longer body length.

composition 

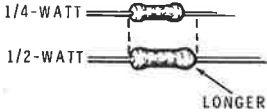
film 

Thank you,
HEATH COMPANY



GENERAL
591-2361

COLOUR CODE FOR FIXED RESISTORS - (B.S.1852-1952)

COLOUR BAND MARKING

FIG1. (COLOURED BAND MARKING PREFERRED)

THIS EXAMPLE SHOWS
A **GRADE I.** RESISTANCE
OF **6,800 Ω ± 5%**

BLUE (6)
GREY (8)
RED (X 10²)
GOLD (± 5%)

{ SALMON PINK (GRADE I.)
{ THIS MAY BE GENERAL BODY COLOUR

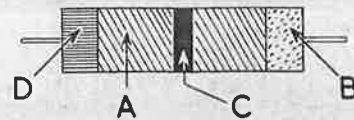
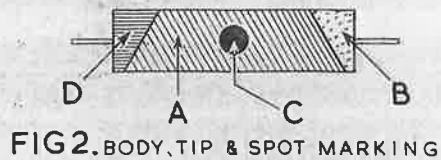

AMERICAN "RMA", "JAN" & COMMERCIAL CODING FOR MOULDED MICA CAPACITORS

CURRENT STANDARD CODE

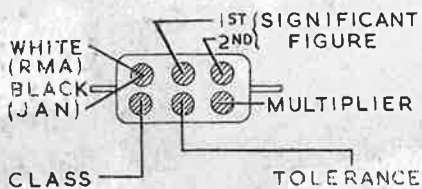

**MOULDED FLAT CAPACITOR
COMMERCIAL CODE**

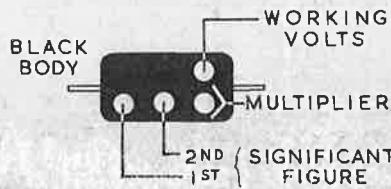

JAN. CODE CAPACITOR

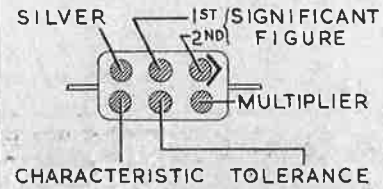

COLOUR CODE FOR RESISTORS AND CAPACITORS

Colour	Value in Ohms or pF for Cols. A, B & C.				COL. D. (TOLERANCE RATING)			CAPACITORS COL. E. TEMP. COEFFICIENT per 10° per °C.
	COL. A. 1st Figure	COL. B. 2nd Figure	COL. C. (MULTIPLIER)		Resistors	Ceramic Capacitors		
			Resistors ohms	Capacitors pF		Up to 10 pF	Over 10 pF	
BLACK	-	0	1	1	-	2 pF	± 20%	0
BROWN	1	1	10	10	± 1%	0.1 pF	± 1%	-30
RED	2	2	100	100	± 2%	-	± 2%	-80
ORANGE	3	3	1,000	1,000	-	-	± 2.5%	-150
YELLOW	4	4	10,000	10,000	-	-	-	-220
GREEN	5	5	100,000	-	-	0.5 pF	± 5%	-330
BLUE	6	6	1,000,000	-	-	-	-	-470
VIOLET	7	7	10,000,000	-	-	-	-	-750
GREY	8	8	100,000,000	.01	-	0.25 pF	-	+30
WHITE	9	9	1,000,000,000	.1	-	1 pF	± 10%	+100
SILVER			.01	-	± 10%	-	-	
GOLD			.1	-	± 5%	-	-	
SALMON								
PINK								
NO "D"								

COLOUR

The Colour coding should be read from left to right, in order, starting from the end and finishing near the middle.

Standard tolerances for resistors are:- Wire-wound: 1%, 2%, 5%, 10%. Composition, Grade 1: 1%, 2%, 5%. Grade 2: 5%, 10%, 20%. (20% is indicated by 4th (or 'D') colour). Grade 1: ("high-stability") composition resistors are distinguished by a salmon-pink fifth ring or body colour. (Reference: B.S.1852: 1952 B.S.I.).

N. B. High-Stability Resistors supplied with this kit are not as a rule colour coded but enamelled in one colour on which the value in Ohms is printed in figures. Capacitors supplied in this kit usually have their capacity clearly marked in figures. Some Capacitors coded as above also have additional "voltage rating" coding.

Assembly and Operation of the Heathkit High Fidelity Stereo Amplifier

MODEL S-99

*P.V. Red Top
Green Bottom*

*Speakers Red + Black
Top L.H. Bottom R.H.*



SPECIFICATIONS

Input Sensitivity and Impedance (each channel)
for full rated output:

X Pick-up 1
Pick-up 2
AUX
RADIO
TAPE

From 4 mV, 100 K Ω , R.I.A.A. LP*
From 180 mV, 47 K Ω , R.I.A.A. LP*
20 mV, 500 K Ω , Linear
100 mV, 350 K Ω , Linear
100 mV, 350 K Ω , Linear

* The value of input impedance chosen will give good results with most pick-ups. If desired, the values recommended by the pick-up manufacturers may be used. See Graph 1 on Page 4.

Outputs (each channel):

Power
TAPE

9 watts per channel (3 or 15 Ω)
200 mV, 47 K Ω , Linear

Front Panel Controls:

Push button input selector
Volume

GRAM, AUX, TAPE, RADIO
Continuously variable, matched ± 1 dB combined with ON/OFF switch

Bass

12 dB boost at 40 c/s
14 dB cut at 40 c/s. See Graph 2 on Page 4

Treble

14 dB boost at 10 Kc/s
14 dB cut at 10 Kc/s. See Graph 2 on Page 4

Filter (Low Pass).....

Continuously variable from 4 Kc/s to 20 Kc/s at 12-14 dB per octave. See Graph 4 on Page 5

Filter (High Pass).....

Built-in rumble filter for Gram only. Provides cutoff below 40 c/s at approximately 12 dB per octave

Balance

Reverse log law, providing Fade to 'OFF' for each channel

Mono/Stereo

Provides for either STEREO or MONO operation

Channel Reverse

Provides a NORMAL or REVERSE stereo position

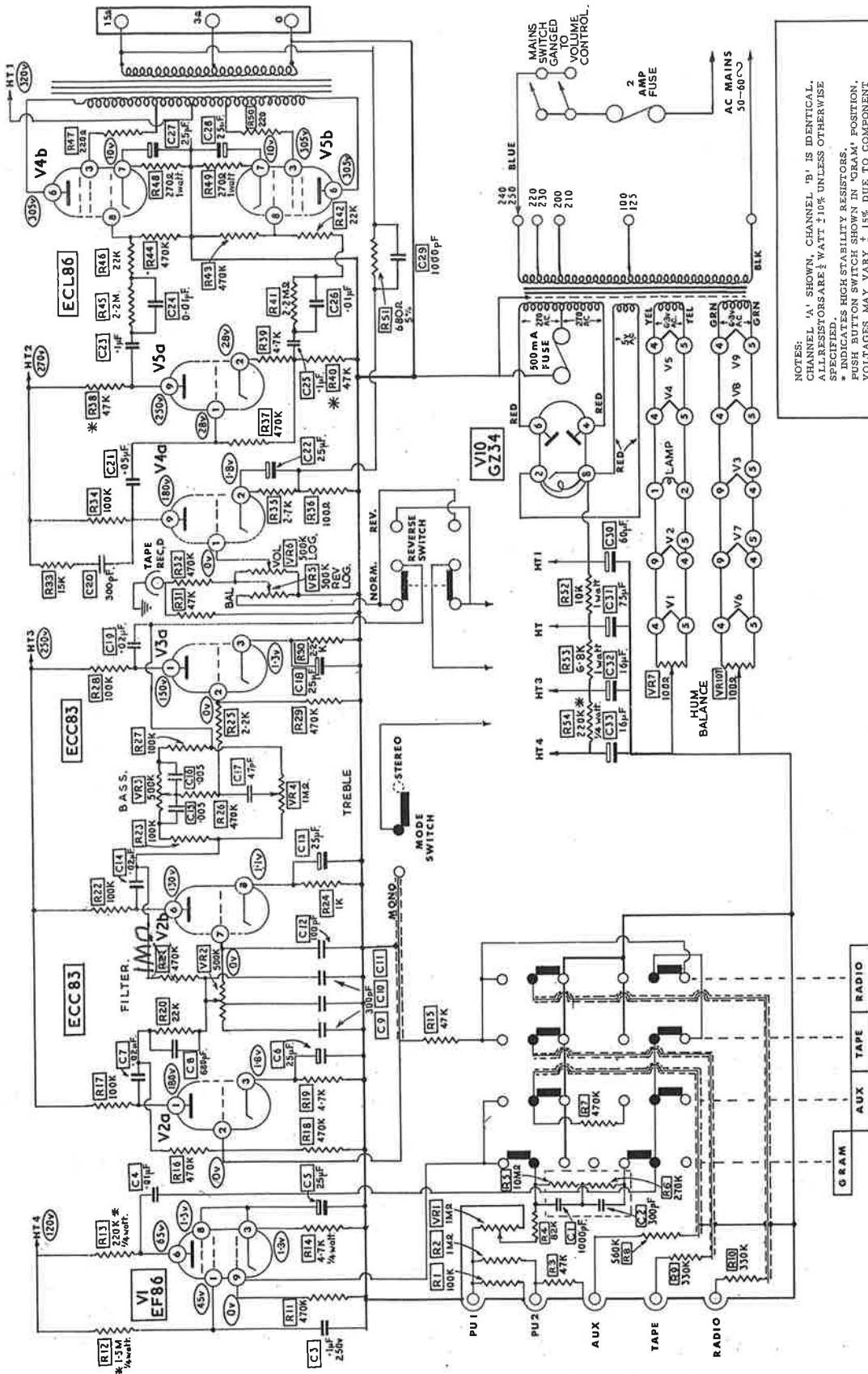

NOTES:
 CHANNEL 'A' SHOWN, CHANNEL 'B' IS IDENTICAL.
 ALL RESISTORS ARE 1/2 WATT ±10% UNLESS OTHERWISE SPECIFIED.
 * INDICATES HIGH STABILITY RESISTORS.
 † RESISTOR VALUES SHOWN IN "GRAM" POSITION.
 VOLTAGES MAY VARY ± 15% DUE TO COMPONENT TOLERANCES.
 ALL VOLTAGES TAKEN WITH HIGH IMPEDANCE METER WITH 250 VOLT A.C. INPUT.
 ALL POTENTIOMETERS ARE GANGED AND MATCHED ± 1 ab.

HEATHKIT STEREO AMPLIFIER, Model S-99.

INPUT Sensitivity:

Pick-up 1
Pick-up 2

Continuously variable from 4 mV
Continuously variable from 180 mV
The same input control functions on Pick-up 1 and 2
One control for each channel

Hum Balance:

Hum and Noise (all ratings are expressed in dB below
9 watts R. M. S. output):

Pick-up 1 (Magnetic)
Pick-up 2 (Crystal)
AUX (Microphone etc.)
RADIO, TAPE

dB down
55
55
60
65
Main loop 26 dB

Feedback:

Harmonic Distortion (measured in the Radio position
and with Tone Controls set flat):

Reference 9 watts output
Frequency % distortion
1,000 c/s 0.2
4,000 c/s 0.35
40 c/s 0.42

Channel Separation (cross talk channel to channel): ..

Reference 9 watts output
Frequency dB down
1,000 c/s 50
10,000 c/s 40

**Frequency Response (measured in the Radio position
and with Tone Controls set flat):**

Reference 1 watt level at 1 Kc/s
Within ± 0.5 dB from 30 c/s to 20 Kc/s

**Power Response (measured in the Radio position and
with Tone Controls set flat):**

Reference 9 watts level at 1 Kc/s
Within ± 1 dB from 40 c/s to 15 Kc/s. See Graph 5

Valve Complement:

- 2 - 6X4
- 3 - 6X5
- 4 - 6X6
- 1 - 6X3

Power Supply:

Heavy duty screened power transformer with full wave
rectifier for HT supply. Capacity input filter
100-125, 200-210, 220-230, 240-250 volts, 50-60 cycles,
100 watts

Power Requirements:

Overall: 13½" wide x 4.11/16" high x 12½" deep
26 lbs.
29 lbs.

Dimensions:

Net Weight:

Shipping Weight:

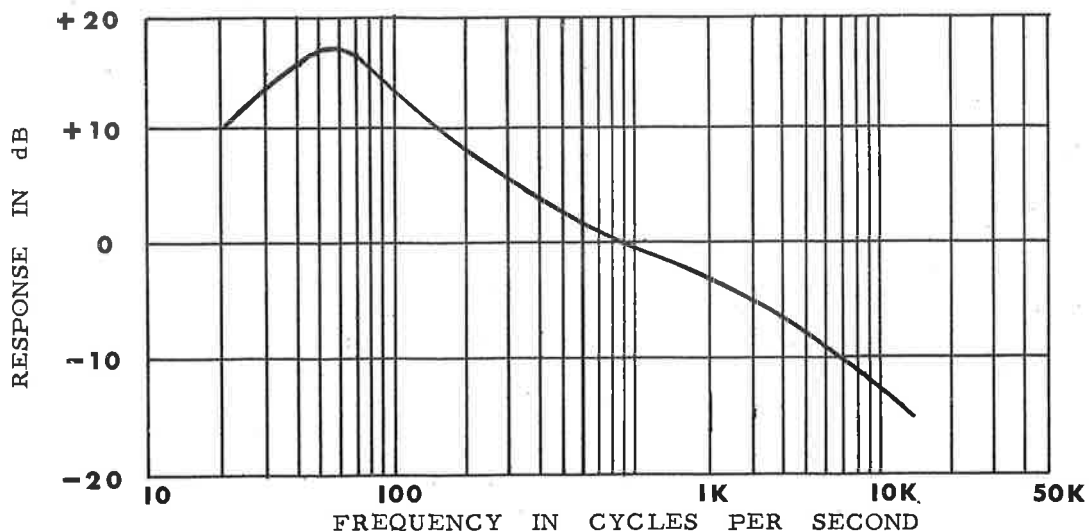

GRAPH 1. GRAM EQUALISATION CURVE

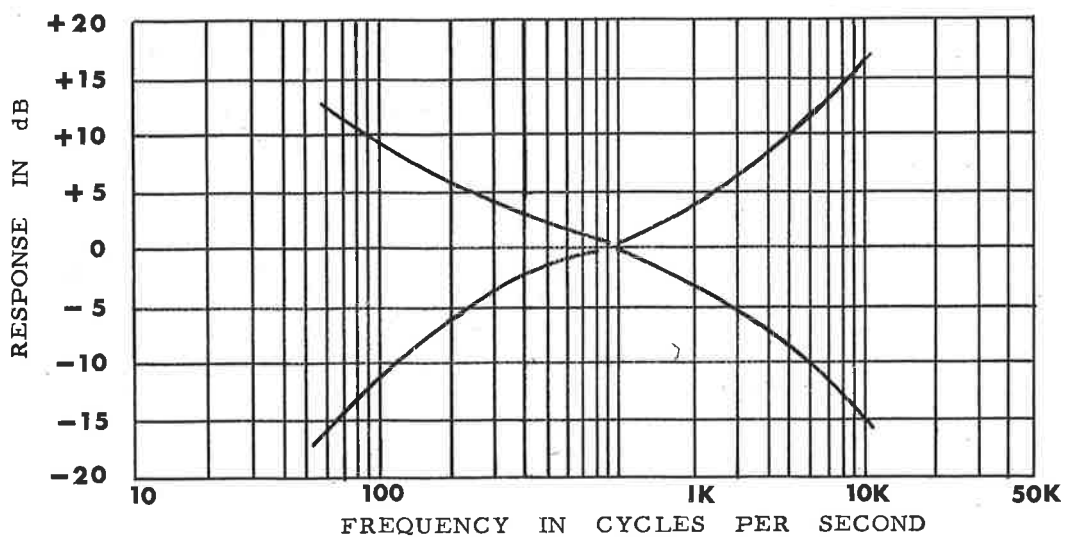

GRAPH 2. TONE CONTROL CHARACTERISTICS

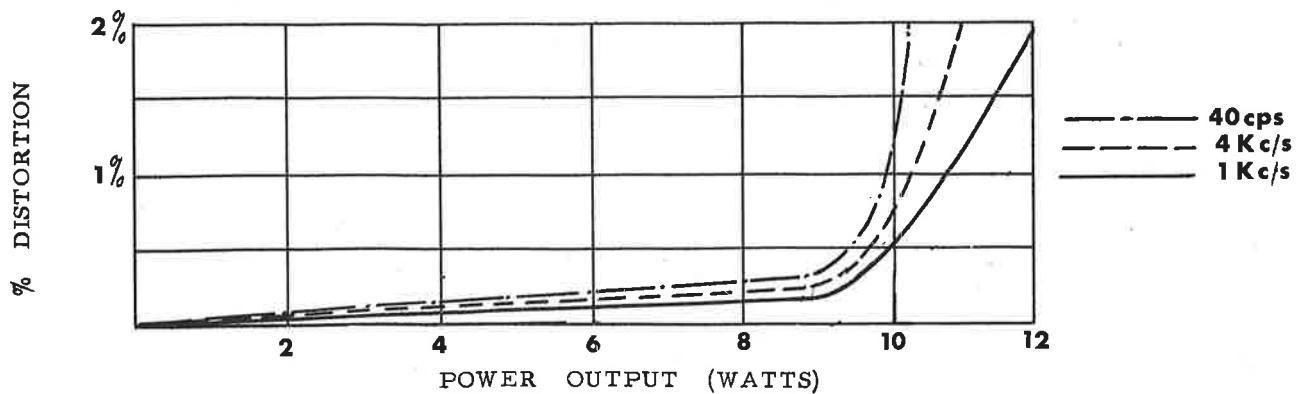

GRAPH 3. TOTAL HARMONIC DISTORTION CURVES

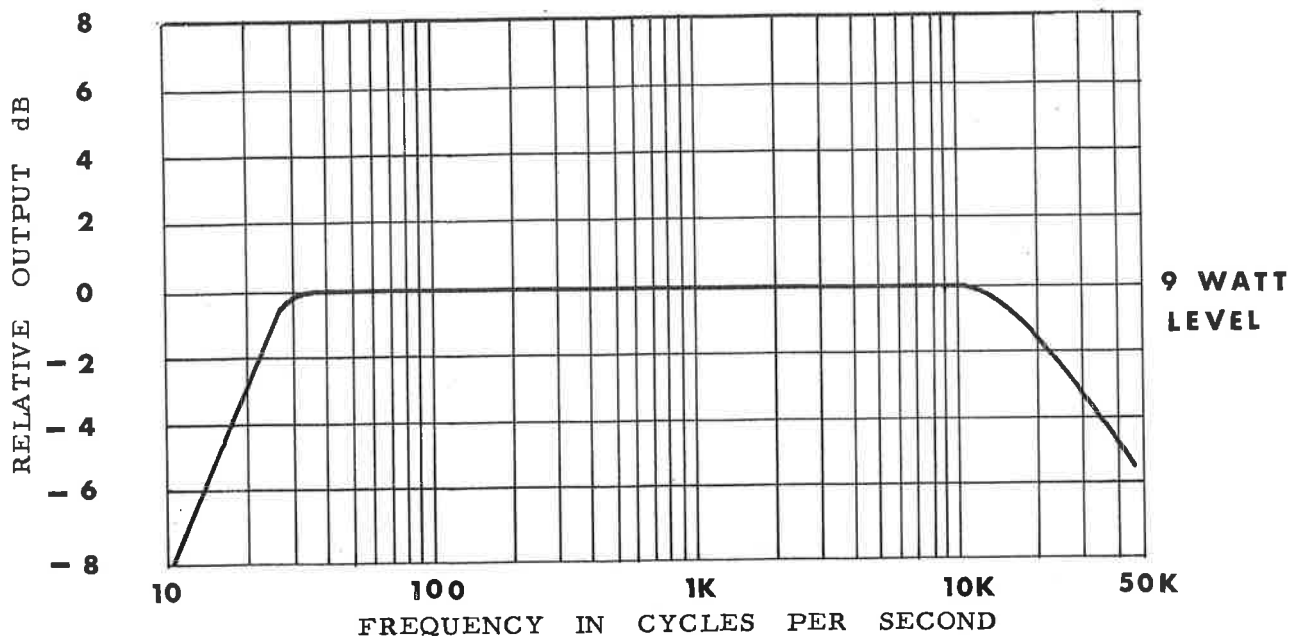

GRAPH 15 POWER RESPONSE

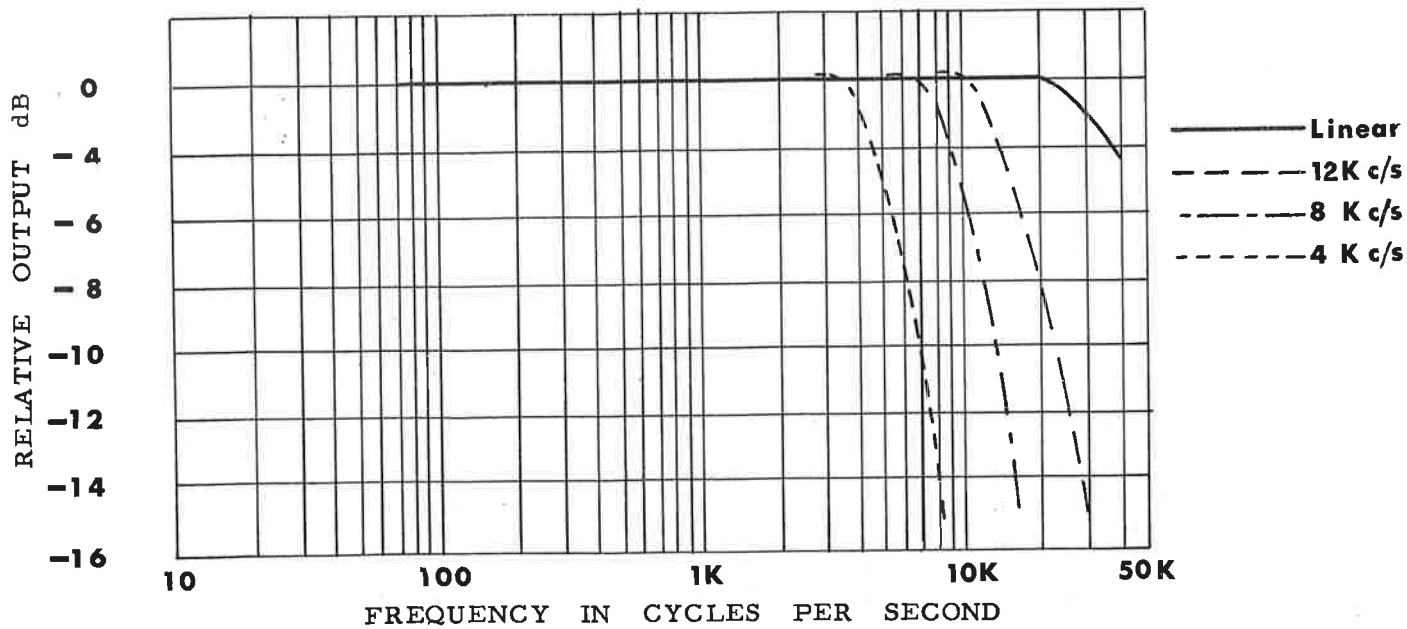

GRAPH 14 FILTER CHARACTERISTICS



INTRODUCTION

The Heathkit Model S-99 is a completely self-contained Stereophonic Amplifier incorporating all worthwhile features for high fidelity stereo and mono sound reproduction. It will do justice to the finest possible programme sources such as gramophone records, radio tuners or complete tape recorders. When assembled in accordance with the instructions provided in this manual, the amplifier will give many years of trouble free listening.

Among the many facilities provided, are a four-position press button switch which gives instant selection of the desired programme source. The switch positions not in use are automatically 'earthed' to prevent cross talk or breakthrough from other signal sources that may be connected.

Bass, Treble, Filter and Volume controls are ganged and accurately matched. The Bass and Treble controls use the well-known Baxandall negative feedback circuit. The low pass filter is continuously variable between 4 and 20 Kc/s with a slope tending to 16 dB's per octave; this will be found extremely useful for attenuating the higher frequencies when high background noise or distortion is present on recordings or radio transmissions. The rate of attenuation is such that the distortion is reduced with the minimum loss in musical values and without causing transient 'ringing'.

A 'built-in' rumble filter is incorporated with the gram compensation network around the 1st EF86 stages. This is necessary to reduce the effects of motor rumble, which is accentuated when speakers having a good bass response are used. Even if the 'rumble' frequencies are themselves inaudible they may overload the output stages of an amplifier and thus cause considerable inter-modulation distortion. It must be remembered that stereo pick-ups are sensitive in both the lateral and vertical directions and that even the best transcription motors are not entirely free from vibration and 'rumble'.

Ten standard 'phono' sockets, five for each channel, are fitted for signal inputs, a sensitivity control is fitted for pick-up sockets 1 and 2, this enables all known types of pick-ups to be used directly, without adding external attenuators.

The amplifier is housed in a grey metal cabinet with two-tone 'perspex' front panel and brass frame, and designed so that it is equally suitable for mounting in an equipment cabinet or free standing on a shelf.

CIRCUIT DESCRIPTION

Low level signals are fed into the first valve, a low-noise pentode type EF86 (V1 or V6) equalising and gain adjustment being effected by a feed-back loop. High level signals are taken to the second stage, one-half of an ECC83 double-triode (V2a or V7a). This stage is stabilised by a feed-back loop and is followed by the variable low pass filter and another triode ($\frac{1}{2}$ ECC83, V2b or V7b). A graph showing the characteristics of this filter is shown on Page 5. A Baxandall tone control network comes next and this is followed by the volume and balance controls. The latter control 'fades' either channel to OFF when in the extreme positions.

The remaining valves are ECL86 triode pentode valves (V4 and V5) and (V8 and V9) which function as driver and phase-splitter as well as push-pull output stages. The ultra-linear arrangement is used and heavy feed-back is applied to the cathode of the driver triode (V4a or V8a). The output transformers are special sectionalised types with high primary inductance (over 190 henries at 50 cycles) and low leakage reactance thus ensuring that power output is maintained at each end of the audio spectrum - and beyond (see Graph 5 on Page 5).

It must be remembered that a frequency response extending to at least 10 times the upper audible limit is necessary for good transient response and to give an adequate margin of stability.

A heavy duty power supply is incorporated consisting of a screened mains transformer, GZ34 full wave rectifier and a high capacity filter network. This low impedance source contributes in no small way to the excellent overload characteristics of the amplifier.

Separate heater supplies and hum balance controls for each channel - plus the copper screened mains transformer help to reduce the hum level to completely negligible proportions.

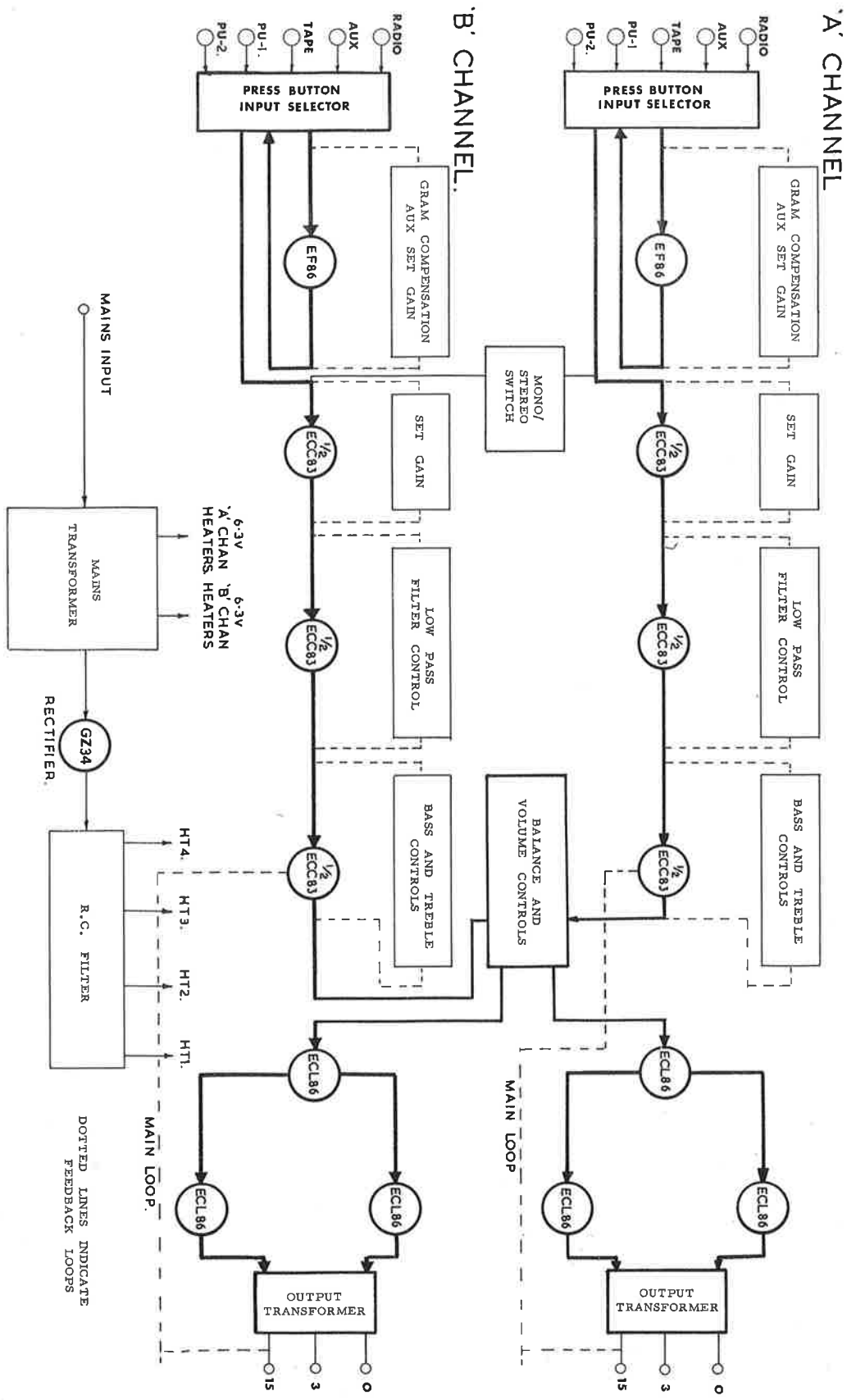

FIGURE-1. BLOCK DIAGRAM.



PRELIMINARY NOTES AND INSTRUCTIONS

The Step-by-Step instructions given in this manual should be followed implicitly to ensure a minimum of difficulty during construction and a completely satisfactory result, including many years of accurate, trouble-free service from the finished instrument.

UNPACK THE KIT CAREFULLY, EXAMINE EACH PART AND CHECK IT AGAINST THE PARTS LIST. In so doing, you will become acquainted with the parts. You will find it helpful to refer to the component identification sheet and also to the general details printed on the inside covers of the manual. If a shortage is found, attach the inspection slip to your claim and notify us promptly.

Lay out all the parts so that they are readily available in convenient categories. Refer to the general information inside the covers of this manual for instructions on how to identify components.

Moulded egg containers make handy trays for holding small parts. Resistors and capacitors may be placed in the edge of a corrugated cardboard box until they are needed.

Unless otherwise stated, use lockwashers under all nuts, and also between controls and the chassis. When shake-proof solder tags are mounted under nuts, the use of lockwashers is unnecessary.

Resistors and capacitors have a tolerance rating of $\pm 10\%$ unless otherwise stated. Therefore a 100 K Ω resistor may test anywhere between 90 and 110 K Ω . Frequently capacitors show an even greater variation such as -50% to +100%. This Heathkit accommodates such variations.

Unless otherwise stated all wire used is insulated. Bare wire is only used where lead lengths are short and there is no possibility of a short circuit. Wherever there is a possibility of the bare wire leads of resistors or capacitors, etc., shorting to other parts or to chassis, such leads must be covered with insulated sleeving.

To facilitate describing the location of parts, all valholders, controls, tagstrips, etc., have been lettered or numbered. Where necessary all such coding is clearly shown in the illustrations. When instructions say, for example, "wire to socket G3", refer to the proper figure and connect a wire to tag 3 of socket G.

Valholders illustrated in the manual are always shown with their tags numbered in a clockwise sequence, from the blank tag position or keyway, when viewed from underneath.

All resistors may be wired either way round.

All capacitors, excepting electrolytic capacitors, may be wired either way round unless otherwise stated.

Carefully letter and number tagstrips, valholders, transformers, etc. A wax pencil is ideal for this purpose.

When mounting resistors and capacitors make sure that the value can be read when in position.

Observe polarity on all electrolytic capacitors, i. e. RED = POSITIVE = +.

A circuit description is included in this manual so that those with some knowledge of electronics will be able to obtain a clearer picture of the actual functioning of this instrument. It is not expected that those with little experience will understand the description completely, but it should be of help in the event that they desire to become more familiar with the circuit operation and thus learn more from building the kit than just the placing of parts and the wiring.

Read this manual right through before starting actual construction. In this way, you will become familiar with the general step-by-step procedure used. Study the pictorials and diagrams to get acquainted with the circuit layout and location of parts. When actually assembling and wiring, READ THROUGH THE WHOLE OF EACH STEP so that no point will be missed.

A tick (✓) should be made in the space provided at the beginning of each instruction immediately it has been completed. This is most important as it will avoid omissions or errors, especially whenever work is interrupted in the course of construction. Some Kit-builders have found it helpful in addition to mark each lead in the pictorial in coloured pencil as it is completed.

Successful instrument construction requires close observance of the step-by-step procedure outlined in this manual. For your convenience, some illustrations may appear in large size folded sheets. It is suggested that these sheets be fastened to the wall over your work area for reference purposes during instrument construction.

The Company reserves the right to make such circuit modification and/or component substitutions as may be found desirable, indication being by "Advice of Change" included in the kit.

NOTE: Daystrom Ltd. will not accept any responsibility or liability for any damage or personal injury sustained during the building, testing, or operation of this instrument.

ALL GUARANTEES ARE VOIDED AND WE WILL NOT REPAIR OR SERVICE INSTRUMENTS IN WHICH ACID CORE SOLDER OR PASTE FLUXES HAVE BEEN USED. WHEN IN DOUBT ABOUT SOLDER, IT IS RECOMMENDED THAT ONLY "60/40" RESIN CORE RADIO SOLDER BE PURCHASED.

PROPER SOLDERING PROCEDURE

Only a small percentage of Heathkit purchasers find it necessary to return an instrument for factory service. Of these, by far the largest proportion function improperly due to poor or improper soldering.

Correct soldering technique is extremely important. Good soldered joints are essential if the performance engineered into the kit is to be fully realised. If you are a beginner with no experience in soldering, half an hour's practice with odd lengths of wire and a valveholder, etc., will be invaluable.

Highest quality resin-cored solder is essential for efficiently securing this kit's wiring and components. The resin core acts as a flux or cleaning agent during the soldering operation.

NO SEPARATE FLUX OR PASTE OF ANY KIND SHOULD BE USED. We specifically caution against the use of so-called "non-corrosive" pastes or liquids. Such compounds, although not corrosive at room temperature, will form residues when heated. These residues are deposited on surrounding surfaces and attract moisture. The resulting compounds are not only corrosive but actually destroy the insulation value of non-conductors. Dust and dirt will tend to accumulate on these "bridges" and eventually will cause erratic or degraded performance of the instrument.

IMPORTANT

IN THE "STEP-BY-STEP" PROCEDURE the abbreviation "NS" indicates that the connection should not yet be soldered, for other wires will be added. At a later stage the letter "S" indicates that the connection must now be soldered. Note that a number appears after each solder (S) instruction. This number indicates the number of leads connected to the terminal in question. For example, if the instructions read, "Connect one lead of a 47 KΩ resistor to tag 1 (S-2)", it will be understood that there should be two leads connected to the terminal at the time it is soldered. This additional check will help to avoid errors.

SPECIAL NOTE: Where a wire is passed through a tag to other parts of the circuit, this will be regarded as two connections (S-2).

When two or more connections are made to the same solder tag a common mistake is to neglect to solder the connections on the bottom. Make sure all the wires are soldered.

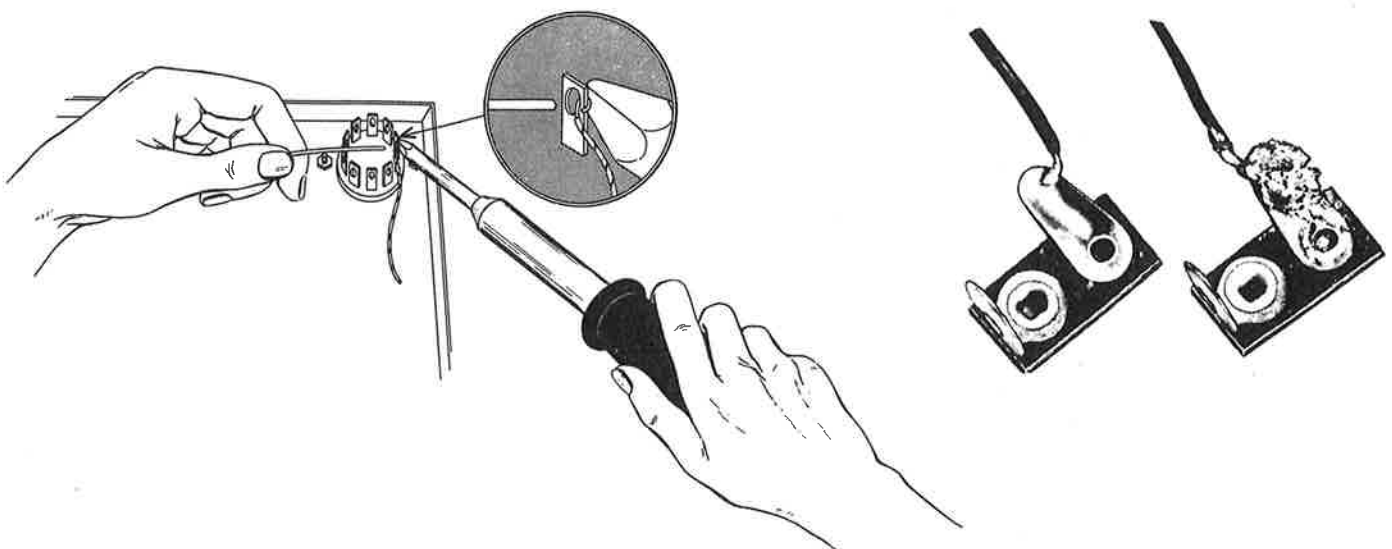

If the tags are bright and clean and wires free of wax, frayed insulation and other foreign substances, no difficulty will be experienced in soldering. Crimp or otherwise secure the wire (or wires) to the terminal, so a good mechanical joint is made without relying on solder for physical strength.

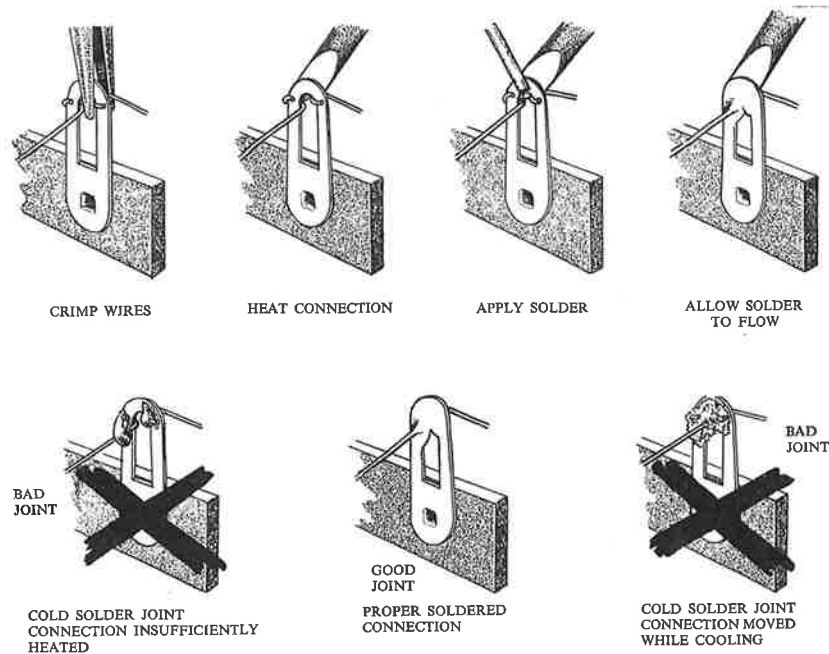

Typical good and bad soldered joints are shown above.

A poor soldered joint will usually be indicated by its appearance. The solder will stand up in a blob on top of the connection, with no evidence of flowing out caused by actual "wetting" of the contact. A crystalline or grainy texture on the solder surface caused by movement of the joint before it solidifies is another evidence of a "cold" connection and possible "dry" joint. In either event, reheat the joint until the solder flows smoothly over the entire junction, cooling to a smooth, bright appearance.

To make a good soldered joint, the clean tip of the hot soldering iron should be placed against the joint to be soldered so that the flat tag is heated sufficiently to melt the solder. Resin core solder is then placed against both the tag and the tip of the iron and should immediately flow over the joint. See illustrations. Use only enough solder to cover the wires at the junction; it is not necessary to fill the entire hole in the tag with solder. Do not allow excess solder to flow into valveholder contacts, ruining the sockets, or to creep into switch sockets and destroy their spring action. Position the work so that gravity tends to keep the solder where you want it.

A clean, well-tinned soldering iron is also important to obtain consistently perfect connections. For most wiring, a 25 to 50 watt iron, or the equivalent in a soldering gun, is very satisfactory. Keep the iron hot and its tip and the connections to be soldered bright and clean. Always place the solder on the heated "work" and then place the bit on top of the solder until it flows readily and "wets" the joint being made. Do not take the solder on to the bit and then try to bring it to the work directly from the soldering iron. Whenever possible a joint should be secured mechanically by squeezing tight with pliers prior to soldering it. The hot soldering bit should frequently be scraped clean with a knife, steel wool or a file, or wiped clean quickly by means of a rag or steel wool.

Do not apply too much solder to the soldered joint. Do not apply the solder to the iron only, expecting that it will roll down onto the connection. Try to follow the instructions and illustrations as closely as possible.

Do not bend a lead more than once around a connecting point before soldering, so that if it should have to come off due to a mistake or for maintenance it will be much easier to remove.

Follow these instructions and use reasonable care during assembly of the kit. This will ensure the deserved satisfaction of having the instrument operate perfectly the first time it is switched on.

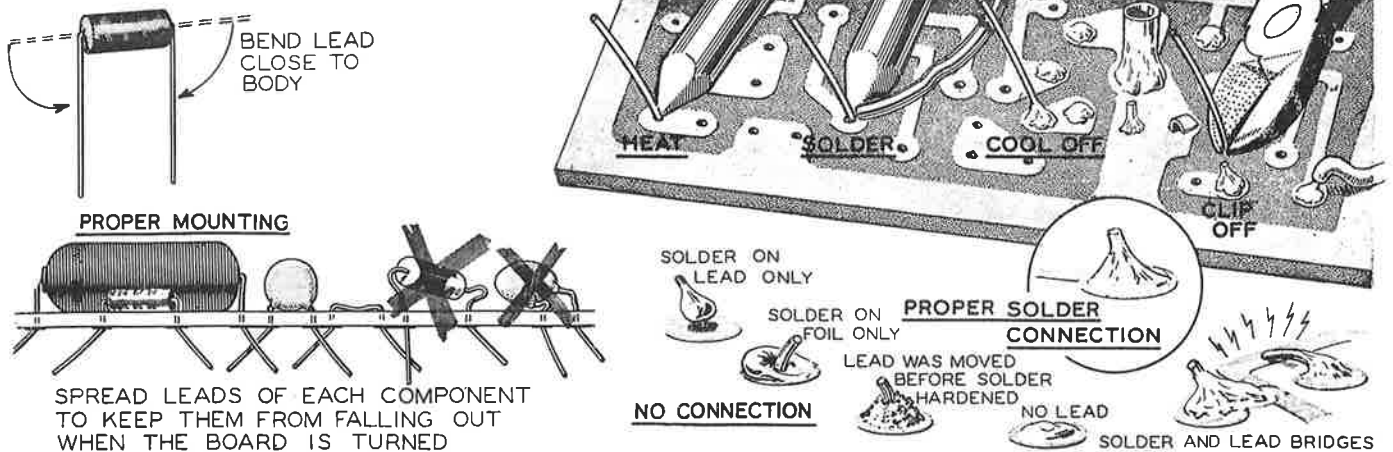

CIRCUIT BOARD WIRING AND SOLDERING

Before attempting any work on the circuit board, read the following instructions carefully and study the figures shown. It is only necessary to observe a few basic precautions which will ensure proper operation of the unit the first time it is turned on.

Proper mounting of components on the board is essential for good performance. A good general rule to follow is that all components on the board should be mounted tightly to the board, unless instructions state otherwise. All leads should be kept as short as possible to minimize the effects of stray capacity in the wiring. Proper and improper methods of mounting are illustrated in the accompanying Figures.

Tubular capacitors and resistors will fit properly if the leads are bent, as shown. Disc capacitors will generally fit in place with no lead preparation other than determining that the leads are straight. Components with tags normally require no preparation unless the tags appear to be bent, in which case they can be straightened with a pair of pliers. Parts should be inserted as instructed, and the leads bent outward slightly, as illustrated, to lock them in place.

Components will be soldered in groups: after a group of components have been installed, instructions will be given to solder them. When the components have been soldered, diagonal cutters may be used to cut off the excess leads close to the board.

The actual technique of soldering leads to a circuit board is quite simple. Position the tip of the soldering iron so that it firmly contacts both the circuit board foil and the wire or tag to be soldered, as shown. Then the solder should immediately be placed between the iron and the joint to be soldered. Remove the solder as soon as it begins to melt and flow on to the lead and foil. Hold the tip of the iron in place only until the solder begins to flow outward over the foil. Then remove the iron quickly.

Avoid overheating the connection. A soldering pencil or small iron (approximately 30 watts) is ideal for use in circuit board work. If a higher wattage iron or soldering gun must be used, precautions must be taken to avoid circuit board damage due to overheating.

The use of excessive amounts of solder will increase the possibility of bridging between foil conductors or plugging holes which are to be left open for wires which may be added later on. If solder is accidentally bridged across insulating areas between conductors, it can be cleaned off by heating the connection carefully and quickly wiping the solder away with a soft cloth. Holes which become plugged can be cleared by heating the area immediately over the hole while gently pushing the lead of a resistor through the hole from the opposite side, and withdrawing the lead before the solder rehardens. Do not force the wire through: too much pressure before the solder has time to soften may separate the foil from the board. In cases where foil does become damaged, repairs can usually be made with little difficulty. A break in the foil can be rejoined with a small piece of bare wire soldered across the gap, or between the foil and the lead of a component.

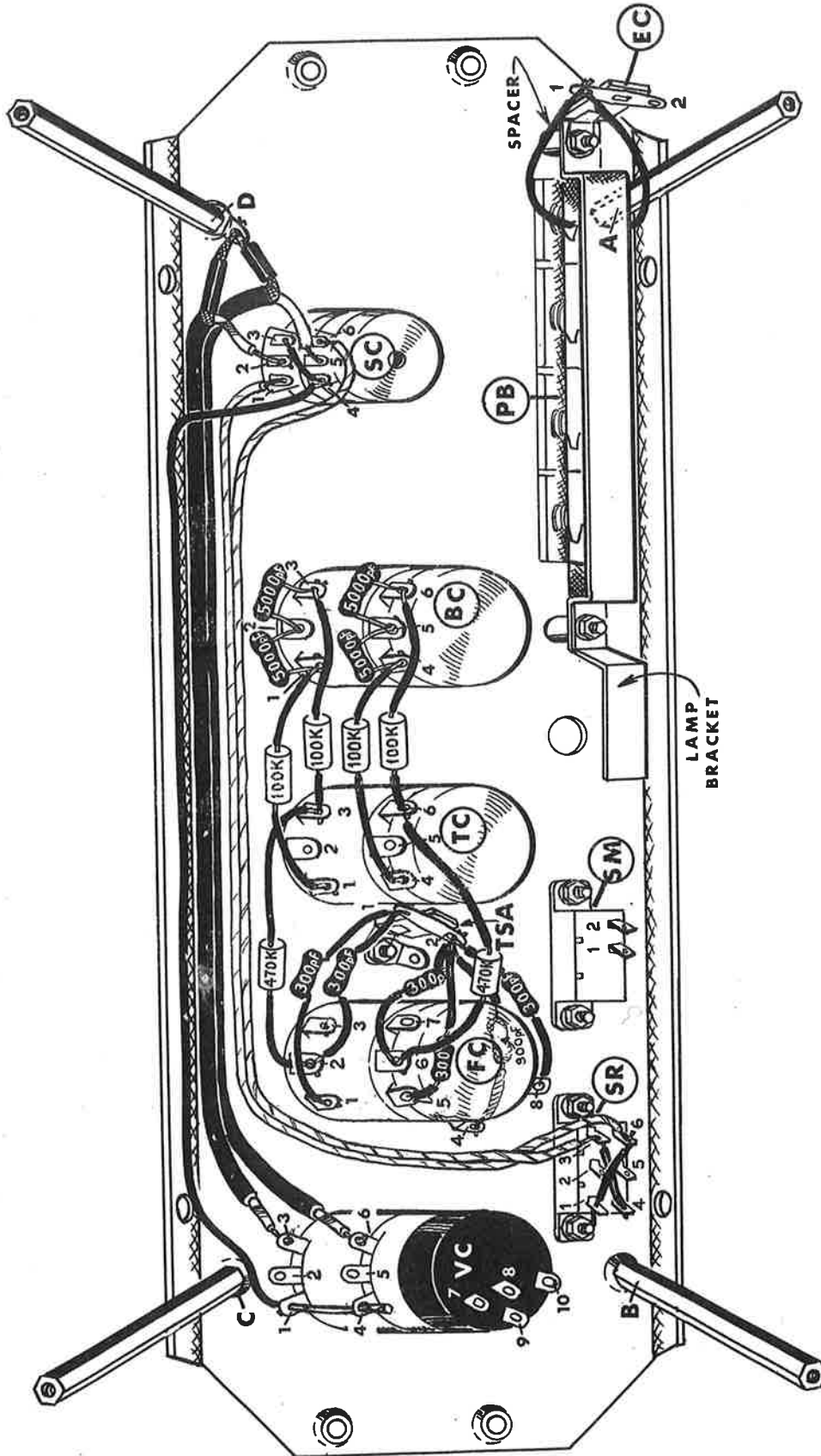

PICTORIAL- I.

STEP-BY-STEP ASSEMBLY

FRONT PANEL ASSEMBLY
SEE PICTORIAL 1

- (✓) If there is an amendment sheet to this manual, make sure that you have made the alterations at the appropriate places.
- (✓) Select the front panel (Part No. 203-540) and place it on your workbench in the same relative position to that shown in Pictorial 1.

NOTE: For identification purposes, all controls are marked with the Part Number.

- (✓) Refer to Figure 2 and mount the 500 K Ω dual control with switch (Part No. 19-516) at location VC. Use a lockwasher between panel and control and a flat washer between panel and 3/8" nut.

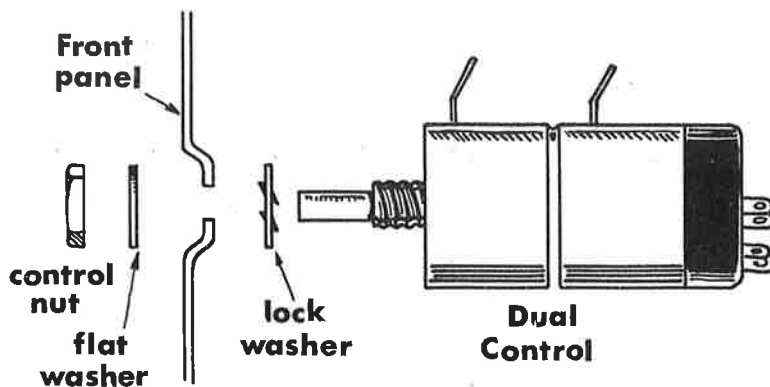

FIGURE-2

- (✓) In the same manner mount the 500 K Ω dual control with centre tap (Part No. 10-541) at location FC.
- (✓) Mount the 1 megohm dual control (Part No. 10-540) at location TC.
- (✓) Mount the 500 K Ω dual control (Part No. 10-542) at location BC.
- (✓) Mount the 500 K Ω dual control (Part No. 10-538) at location SC.
- (✓) Mount the 6-tag slide switch at location SR with two 6BA x 5/16" countersunk head screws and two 6BA nuts. DO NOT USE LOCKWASHERS.
- (✓) Mount the 2-tag slide switch at location SM making sure the two tags are positioned at the bottom right-hand side of the panel. Secure with two 6BA x 5/16" countersunk head screws and two 6BA nuts. DO NOT USE LOCKWASHERS.
- (✓) Mount a 4BA solder tag and 1-way tagstrip at location TSA. Secure with a 4BA x 1/4" binderhead screw and nut. *
- (✓) Select the four 4BA x 3" pillars and mount one in each corner at locations A, B, C and D. Under D mount a 4BA solder tag. Secure each pillar with a 4BA x 1/4" binderhead screw.
- (✓) Using a 1 1/4" length of sleeving at each end, connect a 300 pF ceramic tubular capacitor between FC tag 1 (S-1) and TSA tag 1 (NS).
- (✓) Using 1" length of sleeving at each end, connect a 300 pF ceramic capacitor between FC tag 2 (NS) and TSA tag 1 (NS).
- (✓) Using 1" length of sleeving at each end, connect a 300 pF ceramic capacitor between FC tag 4 (S-1) and TSA tag 2 (NS).
- (✓) Using 1 1/4" length of sleeving at each end, connect a 300 pF ceramic capacitor between FC tag 5 (S-1) and TSA tag 2 (NS).
- (✓) Using 1 1/4" length of sleeving at each end, connect a 300 pF ceramic capacitor between FC tag 6 (NS) and TSA tag 2 (NS).
- (✓) Using 1" length of sleeving at each end, connect a 300 pF ceramic capacitor between FC tag 8 (S-1) and TSA tag 2 (S-4).
- (✓) Using 3/8" length of sleeving at each end, connect a 5000 pF ceramic capacitor between BC tags 1 (NS) and 2 (NS).

* Make sure that tagstrip is clear of potentiometer TC.

- (✓) Using a 3/8" length of sleeving at each end, connect a 5000 pF ceramic capacitor between BC tags 2 (NS) and 3 (NS).
- (✓) Using a 3/8" length of sleeving at each end, connect a 5000 pF ceramic capacitor between BC tags 4 (NS) and 5 (NS).
- (✓) Using a 3/8" length of sleeving at each end, connect a 5000 pF ceramic capacitor between BC tags 5 (NS) and 6 (NS).
- (✓) Using a 1" length of sleeving at each end, connect a 100 KΩ resistor (BROWN, BLACK, YELLOW) between BC tag 3 (S-2) and TC tag 3 (NS).
- (✓) Using a 1" length of sleeving at each end, connect a 100 KΩ resistor (BROWN, BLACK, YELLOW) between BC tag 1 (S-2) and TC tag 1 (NS).
- (✓) Using a 1" length of sleeving at each end, connect a 100 KΩ resistor (BROWN, BLACK, YELLOW) between BC tag 6 (S-2) and TC tag 6 (NS).
- (✓) Using a 1" length of sleeving at each end, connect a 100 KΩ resistor (BROWN, BLACK, YELLOW) between BC tag 4 (S-2) and TC tag 4 (NS).
- (✓) Using a 1 1/4" length of sleeving at each end, connect a ^{1 MΩ} ~~470 KΩ~~ resistor (~~YELLOW, VIOLET, YELLOW~~) ^(BROWN, BLACK, GREEN) between TC tag 3 (NS) and FC tag 2 (NS).
- (✓) Using a 1 1/4" length of sleeving at each end, connect a ^{1 MΩ} ~~470 KΩ~~ resistor (~~YELLOW, VIOLET, YELLOW~~) between TC tag 6 (NS) and FC tag 6 (NS).
- (✓) Using the thin bare wire and sleeving, connect a link between SC tags 3 (S-1) and 4 (NS).
- (✓) Connect a 10" length of BLACK wire between SC tag 4 (S-2) and VC tag 1 (NS).
- (✓) Connect a 1" length of thick (18 swg.) bare wire between VC tags 1 (S-2) and 4 (S-1). Further wires will be connected to this bare wire later.
- (✓) Prepare two 11" lengths of screened cable as shown in Figures 4(a and b) on Page 17.
- (✓) Connect one 11" length of screened cable, one end (inner wire) to SC tag 2 (S-1) with screen wire to solder tag D (NS) and the other end to VC tag 3 (NS). NOTE: When soldering the inner wire do not use excessive heat as the insulation surrounding the inner conductor will melt.
- (✓) Connect the other 11" length of screened cable, one end (inner wire) to SC tag 5 (S-1) with screen wire to solder tag D (S-2) and the other end to VC tag 6 (NS). Observe previous precautions.
- (✓) Connect a 12" length of YELLOW wire between ^{SC tag 6} ~~SC tag 1~~ (S-1) and SR tag 6 (NS). Route this wire under the panel flange and between controls VC and FC.
- (✓) Connect a 12" length of YELLOW wire between SC tag ¹ ~~6~~ (S-1) and SR tag 3 (NS). Route this wire under the panel flange and between controls VC and FC.
- (✓) Using a 3/4" length of sleeving and thin bare wire, connect a link between SR tags 3 (S-2) and 4 (S-1).
- (✓) Using a 3/4" length of sleeving and thin bare wire, connect a link between SR tags 6 (S-2) and 1 (S-1).

Lay this assembly aside until later.

PRESS BUTTON SWITCH WIRING
SEE PICTORIAL 2

NOTE: The wire links may be placed for ease of soldering between the slots on the top of each tag. Use 5/8" of sleeving between each tag and the thin (22 swg.) bare wire. A wire passing through a tag will count as two wires and will have a (S-2) instruction.

- (✓) Position switch with the wide space as shown in Pictorial ² Top View and connect a wire link between TV tags 1 (S-1) and 7 (NS).

TOP
VIEW
TV. 1-24

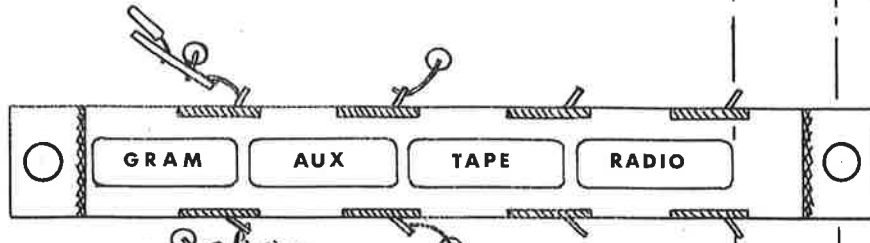
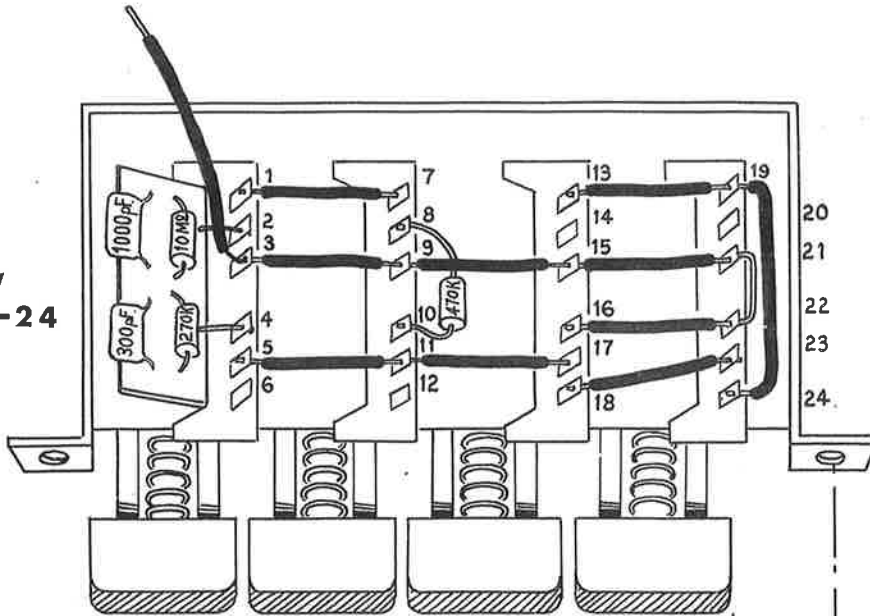

COVER WITH
INSULATION TAPE.

NOTE:
WIDE SPACE
THIS SIDE

BOTTOM
VIEW
BV. 1-24

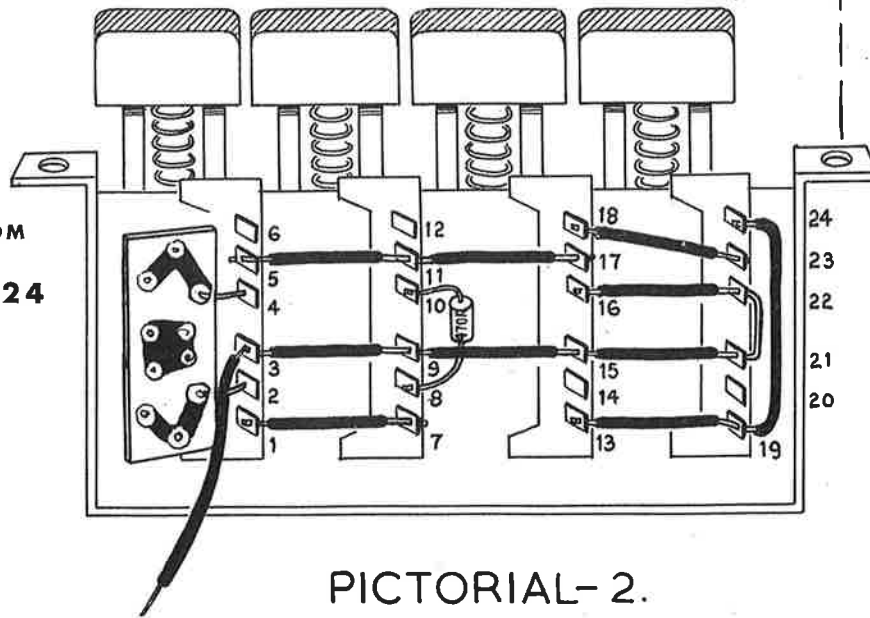

PICTORIAL-2.

- () Connect a wire link between TV tags 13 (NS), 19 (S-2) and 24 (S-1) using $1\frac{1}{4}$ " sleeving between tags 19 and 24.
- (✓) Connect a wire link between tags TV3 (NS), TV9 (S-2), TV15 (S-2), TV21 (S-2), TV22 (S-2) and TV16 (S-1).
- (✓) Connect one end of a 2" length of BLACK wire to TV tag 3 (S-2). The other end will be connected later.
- (✓) Connect a wire link between tags TV5 (S-1), TV11 (S-2) and TV17 (NS).
- (✓) Connect a wire link between tags TV18 (S-1) and TV23 (S-1).
- (✓) Using $\frac{3}{8}$ " sleeving at each end, connect a 470 K Ω resistor (YELLOW, VIOLET, YELLOW) between tags TV10 (S-1) and TV8 (NS).

(✓) Refer to Figure 3 and select the two small printed circuit boards, two 300 pF silver mica capacitors, two 1000 pF silver mica capacitors, two 270 K Ω resistors (RED, VIOLET, YELLOW) and two 10 megohm resistors (BROWN, BLACK, BLUE).

(✓) Refer to the section PRINTED CIRCUIT WIRING before proceeding.

() (✓) Insert and solder a 270 K Ω resistor (RED, VIOLET, YELLOW) in the bottom left-hand pair of holes on the small circuit board.

() (✓) In the same manner, insert and solder a 10 megohm resistor (BROWN, BLACK, BLUE) in the bottom right-hand pair of holes.

() (✓) Insert and solder a 300 pF silver mica capacitor in the left-hand pair of holes.

() (✓) Insert and solder a 1000 pF silver mica capacitor in the right-hand pair of holes.

() (✓) Insert and solder one end of a $\frac{3}{4}$ " length of bare wire in the circuit board holes A and G.

(✓) Repeat the above FIVE steps.

(✓) Connect one circuit board assembly, wire end A to tag TV4 (S-1) and wire end G to TV2 (NS).

(✓) Turn the switch over and connect a wire link between tags BV1 (S-1) and BV7 (NS).

(✓) Connect a wire link between tags BV13 (NS), BV19 (S-2) and BV24 (S-1), using $1\frac{1}{4}$ " sleeving between tags 19 and 24.

(✓) Connect a wire link between tags BV3 (NS), BV9 (S-2), BV15 (S-2), BV21 (S-2), BV22 (S-2) and BV16 (S-1).

(✓) Connect one end of a 2" length of BLACK wire to BV tag 3 (S-2). The other end will be connected later.

(✓) Connect a wire link between tags BV5 (S-1), BV11 (S-2) and BV17 (NS).

() Connect a wire link between tags BV18 (S-1) and BV23 (S-1).

(✓) Using $\frac{3}{8}$ " sleeving at each end, connect a 470 K Ω resistor (YELLOW, VIOLET, YELLOW) between tags BV10 (S-1) and BV8 (NS).

(✓) Connect the other small circuit board assembly, wire end A to tag BV4 (S-1) and wire end G to BV2 (NS).

(✓) Carefully inspect all soldered joints made on the press button switch and resolder any that appear to be badly soldered.

(✓) Refer to the middle view on Pictorial 2 and cover the foil side of the bottom circuit board with insulation tape. Position the board as shown.

* () Test the action of each button on the press button switch to ensure that none leads are binding its operation. If necessary re-position for any leads

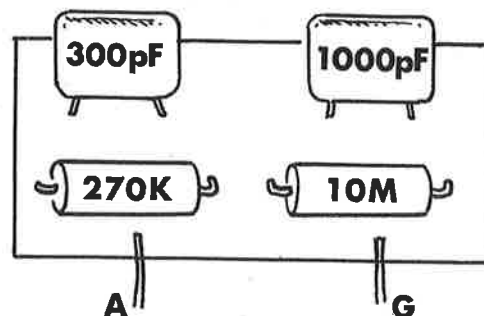

FIGURE-3

(A) Refer to Pictorial 1 and mount the press button switch to the front panel using two 4BA x $\frac{3}{4}$ " binderhead screws with a 4BA x $\frac{3}{8}$ " spacer between front panel and switch bracket. Also mount the lamp bracket on the left-hand side and a 1-way tagstrip EC on the right-hand side securing with 4BA lockwashers and nuts.

(B) Connect the BLACK wire from TV tag 3 to EC tag 1 (NS).

(C) Connect the BLACK wire from BV tag 3 to EC tag 1 (S-2).

Lay this assembly aside until later.

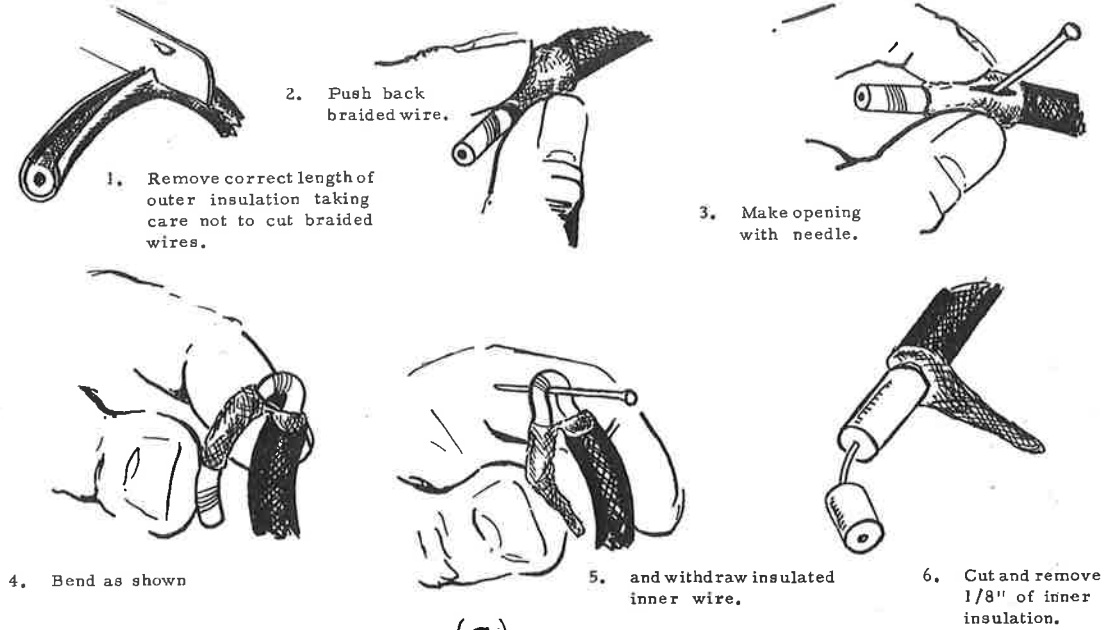

(a)

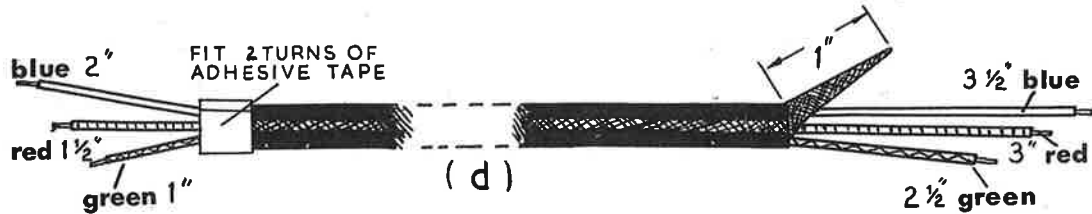
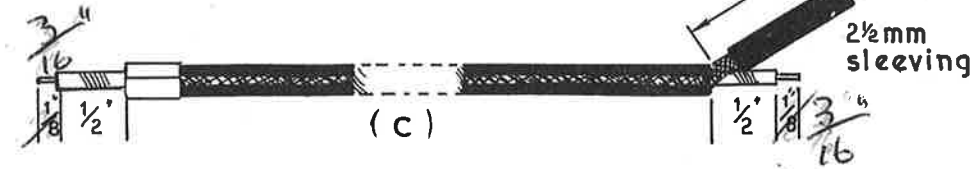
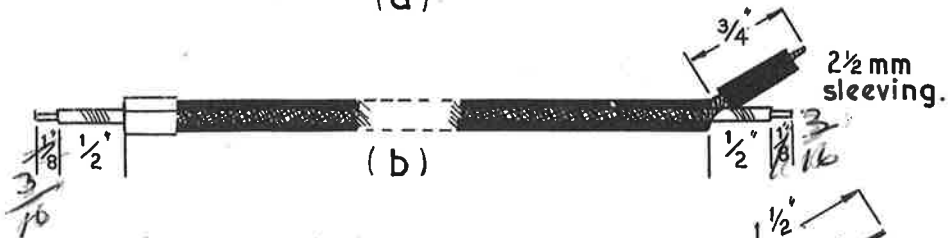

FIGURE-4

REAR PANEL ASSEMBLY
SEE PICTORIAL 3

- (1) Select the rear panel and position as shown.
- (2) Mount a 1 megohm control (Part No. 10-530) at location AP with 6 BA x $\frac{1}{4}$ " binderhead screws. *3" CABE 16 CHESSHEAD*
- (3) Mount a 1 megohm control (Part No. 10-530) at location BP with 6 BA x $\frac{1}{4}$ " binderhead screws. *CHESSHEAD*
- (4) Mount a 100 Ω control (Part No. 11-509) at location HA securing with a 3/8" lockwasher between panel and control and 3/8" flat washer and nut.
- (5) In the same manner mount a 100 Ω control (Part No. 11-509) at location HB.
- (6) Mount a 3-way terminal strip on the outside of panel at location OA with two 6 BA x $\frac{1}{4}$ " binderhead screws, lock washers and nuts.
- (7) In the same manner mount a 3-way terminal strip at location OB.



Note. BLANK SPACE between tags 5 & 6.

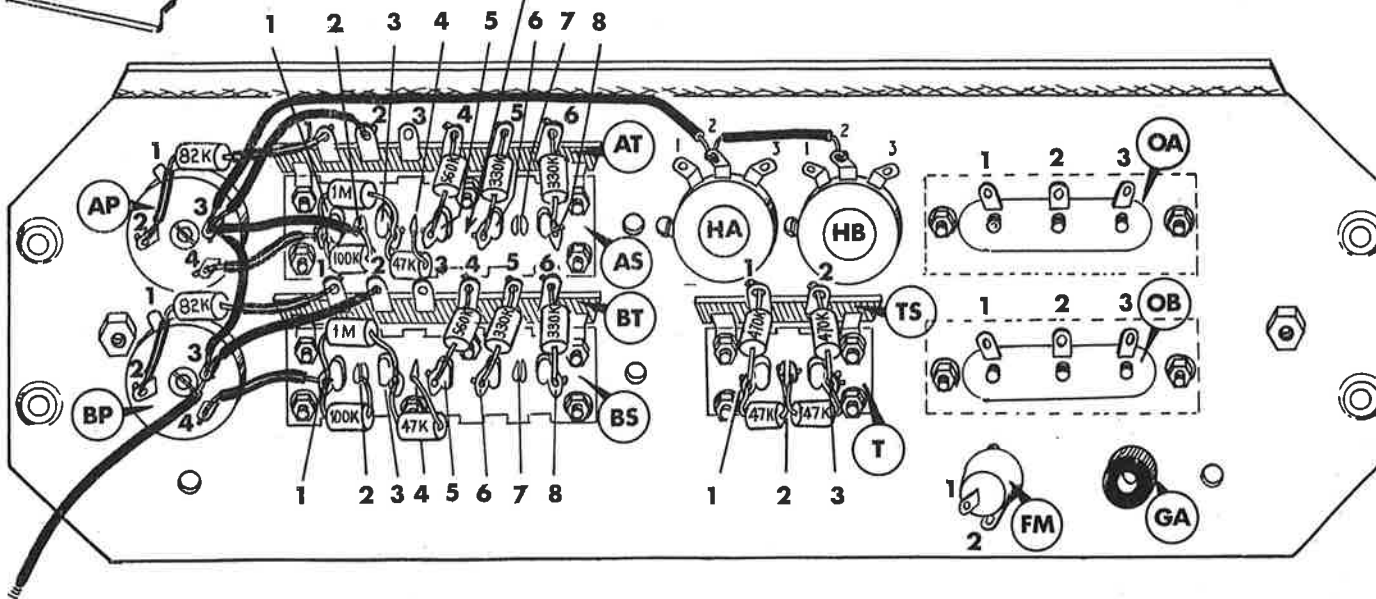

PICTORIAL-3.

- (✓) Insert a 3/8" grommet in hole GA.
- (✓) Select the panel mounting fuseholder and remove the cap and nut. Insert the threaded end through hole FM and ensure the locking pins engage with the corresponding pins in chassis hole. Replace nut.
- (✓) Insert a 2.5 amp fuse in the cap and replace in holder.
- (✓) Mount a 2-way phono socket with a 2-way tagstrip at locations T and TS securing with four 6BA x 1/4" binderhead screws, lockwashers and nuts.
- (✓) Mount a 5-way phono socket as AS with the blank space positioned between tags 5 and 6 as shown. At the same time mount a 6-way tagstrip at location AT securing with six 6BA x 1/4" binderhead screws, lockwashers and nuts.
- (✓) In the same manner mount a 5-way phono socket at BS with a 6-way tagstrip at location BT securing with six 6BA x 1/4" binderhead screws, lockwashers and nuts.
- (✓) Cut the wire ends of a 47 KΩ resistor (YELLOW, VIOLET, ORANGE) to 5/8" long and connect between tags T1 (NS) and T2 (NS).
- (✓) In the same manner connect a 47 KΩ resistor (YELLOW, VIOLET, ORANGE) between tags T2 (S-2) and T3 (NS).
- (✓) Connect a 470 KΩ resistor (YELLOW, VIOLET, YELLOW) between tags T1 (S-2) and TS1 (NS).
- (✓) Connect a 470 KΩ resistor (YELLOW, VIOLET, YELLOW) between tags T3 (S-2) and TS2 (NS).

NOTE: When connecting the following resistors, position each resistor as shown in the inset on Pictorial 3. This is necessary to provide adequate clearance for the input screen which is fitted later.

- (✓) Connect a 330 KΩ resistor (ORANGE, ORANGE, YELLOW) between tags AS8 (S-1) and AT6 (NS).
- (✓) Connect a 330 KΩ resistor (ORANGE, ORANGE, YELLOW) between tags AS6 (S-1) and AT5 (NS).
- (✓) Connect a 330 KΩ resistor (ORANGE, ORANGE, YELLOW) between tags BS8 (S-1) and BT6 (NS).
- (✓) Connect a 330 KΩ resistor (ORANGE, ORANGE, YELLOW) between tags BS6 (S-1) and BT5 (NS).
- (✓) Connect a 560 KΩ resistor (GREEN, BLUE, YELLOW) between tags AS5 (S-1) and AT4 (NS).
- (✓) Connect a 560 KΩ resistor (GREEN, BLUE, YELLOW) between tags BS5 (S-1) and BT4 (NS).
- (✓) Connect a 47 KΩ resistor (YELLOW, VIOLET, ORANGE) between tags AS3 (NS) and AS4 (S-1) (short tag).
- (✓) Connect a 47 KΩ resistor (YELLOW, VIOLET, ORANGE) between tags BS3 (NS) and BS4 (S-1) (short tag).
- (✓) Connect a 100 KΩ resistor (BROWN, BLACK, YELLOW) between tags AS1 (NS) and AS2 (NS) (short tag).
- (✓) Connect a 100 KΩ resistor (BROWN, BLACK, YELLOW) between tags BS1 (NS) and ~~BS2 (S-1) (short tag)~~ ^{BP tag 3 (NS)}.
- (✓) Connect a 1 megohm resistor (BROWN, BLACK, GREEN) between tags AS1 (NS) and AS3 (S-2).
- (✓) Connect a 1 megohm resistor (BROWN, BLACK, GREEN) between tags BS1 (NS) and BS3 (S-2).

NOTE: Use 22 swg. bare wire and 1 1/2 m.m. sleeving for the following steps, keep all wire links short and direct.

- (✓) Connect a sleeved wire link between HB tag 2 (S-1) and HA tag 2 (NS).
- (✓) Connect a 6" length of BLACK wire between HA tag 2 (S-2) and control AP tag 3 (NS).
- (✓) Connect a sleeved wire link between AS tag 2 (S-2) (short tag) and AP tag 3 (NS).
- (✓) Connect a sleeved wire link between AT tag 2 (NS) and AP tag 3 (NS).



- (✓) Connect a sleeved wire link between AP tag 3 (S-4) (make sure all wires are soldered) and BP tag 3 (NS).
- (✓) Connect a sleeved wire link between BT tag 2 (NS) and BP tag 3 (NS).
- (✓) Connect one end of a 14" length of BLACK wire to BP tag 3 (S-4) (make sure all wires are soldered). Leave the other end free.
- (✓) Connect a sleeved wire link between AS tag 1 (S-3) and AP tag 4 (S-1).
- (✓) Connect a sleeved wire link between BS tag 1 (S-3) and BP tag 4 (S-1).
- (✓) Using a $\frac{3}{4}$ " length of sleeving at each end, connect an 82 K Ω resistor (GREY, RED, ORANGE) between AP tag 1 (S-1) and AT tag 1 (NS).
- (✓) Using a $\frac{3}{4}$ " length of sleeving at each end, connect an 82 K Ω resistor (GREY, RED, ORANGE) between BP tag 1 (S-1) and BT tag 1 (NS).

WIRING OF SCREENED CABLE
SEE PICTORIAL 4

- (✓) Refer to Figures 4(a and d) and prepare as shown two 18" lengths of 3-core screened cable. Tape one end as shown.
- (✓) Take one length of prepared 3-core cable and connect the exposed screened braid end to AP tag 1 (S-1).
- (✓) Connect the GREEN wire to AT tag 4 (S-2).
- (✓) Connect the RED wire to AT tag 5 (S-2).
- (✓) Connect the BLUE wire to AT tag 6 (S-2).
- (✓) Take the other prepared length of 3-core cable and connect the exposed screened braid end to BP tag 1 (S-1).
- (✓) Connect the GREEN wire to BT tag 4 (S-2).
- (✓) Connect the RED wire to BT tag 5 (S-2).
- (✓) Connect the BLUE wire to BT tag 6 (S-2).
- () Prepare a 15" length of single screened cable as shown in Figures 4(a and b). Connect the exposed screened braid end to AT tag 2 (S-2) and the inner wire to AT tag 1 (S-2). NOTE: When soldering the inner wire do not use excessive heat as the insulation surrounding the inner conductor will melt.
- (✓) Prepare a 15" length of single screened cable as shown in Figures 4(a and b). Connect the exposed screened braid end to BT tag 2 (S-2) and the inner wire to BT tag 1 (S-2). Observe previous precautions.

Lay this assembly aside.

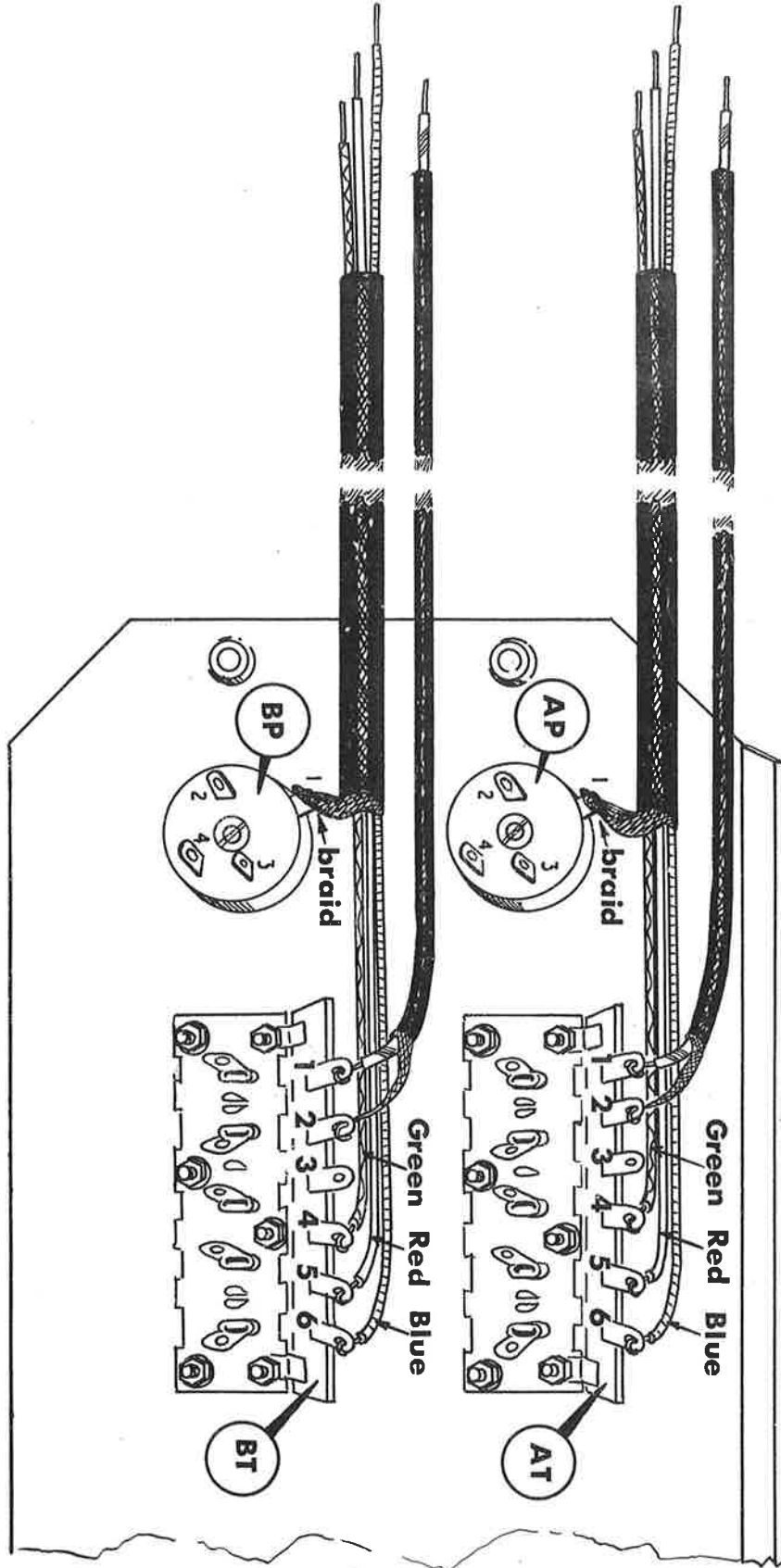

PICTORIAL-4.

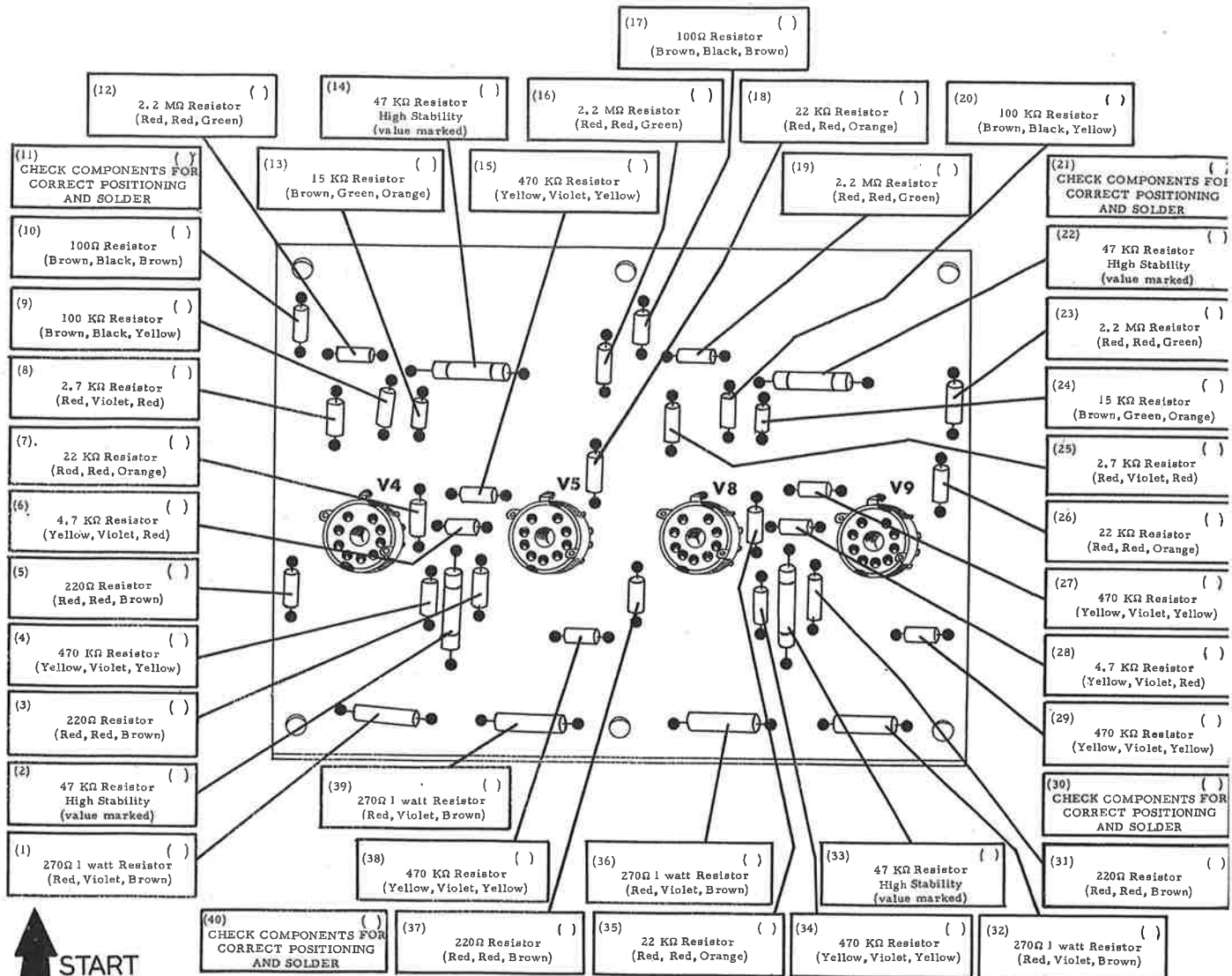

PICTORIAL-5.

POWER AMPLIFIER CIRCUIT BOARD ASSEMBLY (Stage 1)
SEE PICTORIAL 5

NOTE: Use the thin gauge solder for all printed circuit wiring.

- (U) Select the power amplifier circuit board and four printed circuit type valveholders.
- (V) Locate and insert by pressing firmly in the circuit board, a valveholder in locations V4, V5, V8 and V9. It should be noted that there is an earth tag attached to the metal surround which is offset from the other 9 tags.
- (W) Solder all the tags on each valveholder including the centre spigot and offset tag.

Continue with steps shown on Pictorial 5.

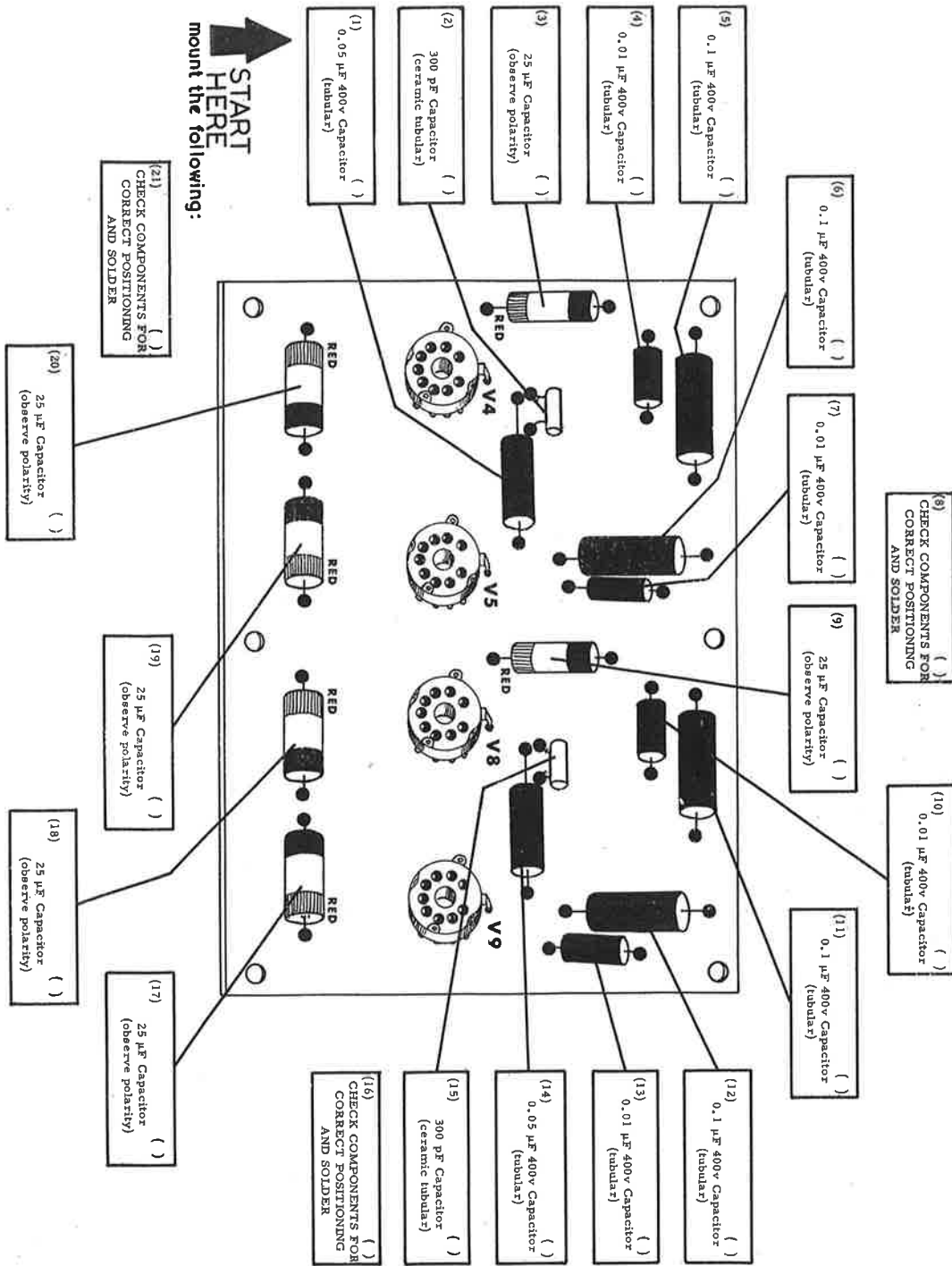

PICTORIAL-6.

POWER AMPLIFIER CIRCUIT BOARD ASSEMBLY (Stage 2)
SEE PICTORIAL 6

() Continue with the steps shown on Pictorial 6.

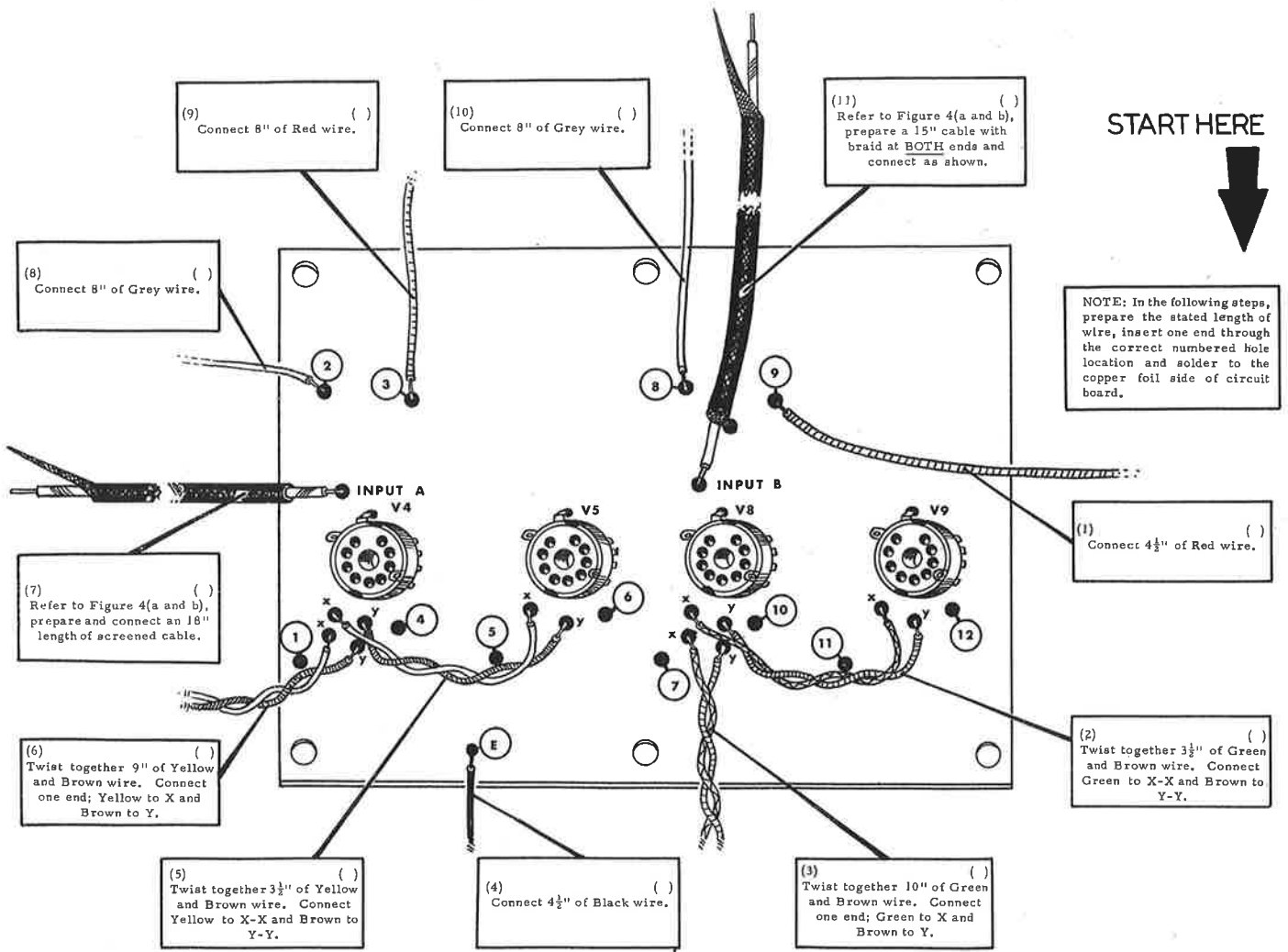

PICTORIAL-7.

'X's' and 'Y's' on this pictorial are not shown on the circuit board. Relative locations as seen from the net on the pictorial are as on the board looking from the non-metallized side!

POWER AMPLIFIER CIRCUIT BOARD ASSEMBLY (Stage 3)
SEE PICTORIAL 7

- (4) Continue with the steps shown on Pictorial 7.
- (4) The assembly of this circuit board is now completed - temporarily place to one side until required later.

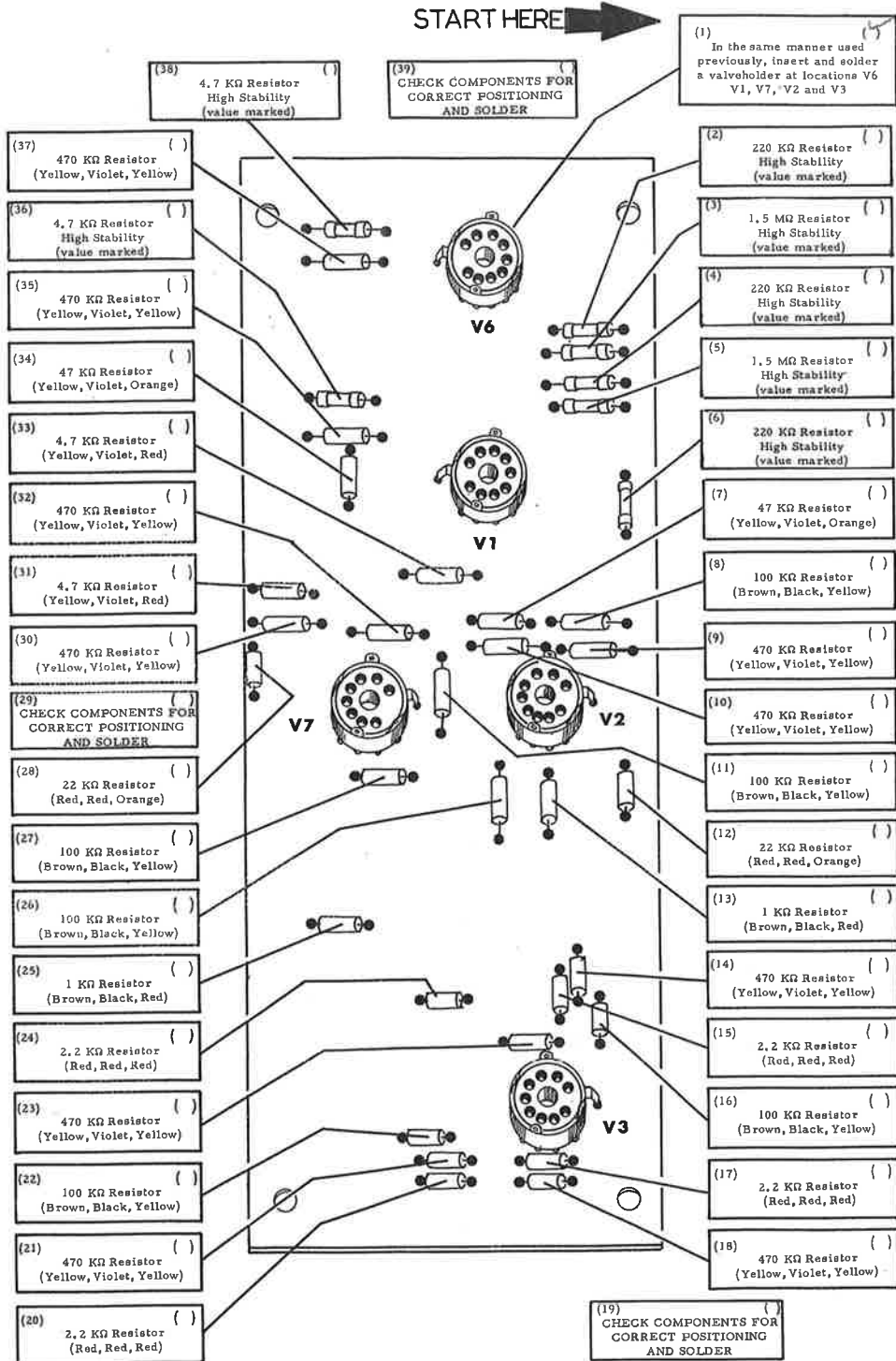

PICTORIAL-8.

PRE-AMPLIFIER CIRCUIT BOARD ASSEMBLY (Stage 1)
SEE PICTORIAL 8

() Select the pre-amplifier circuit board and five printed circuit type valveholders and continue with the steps shown on Pictorial 8.

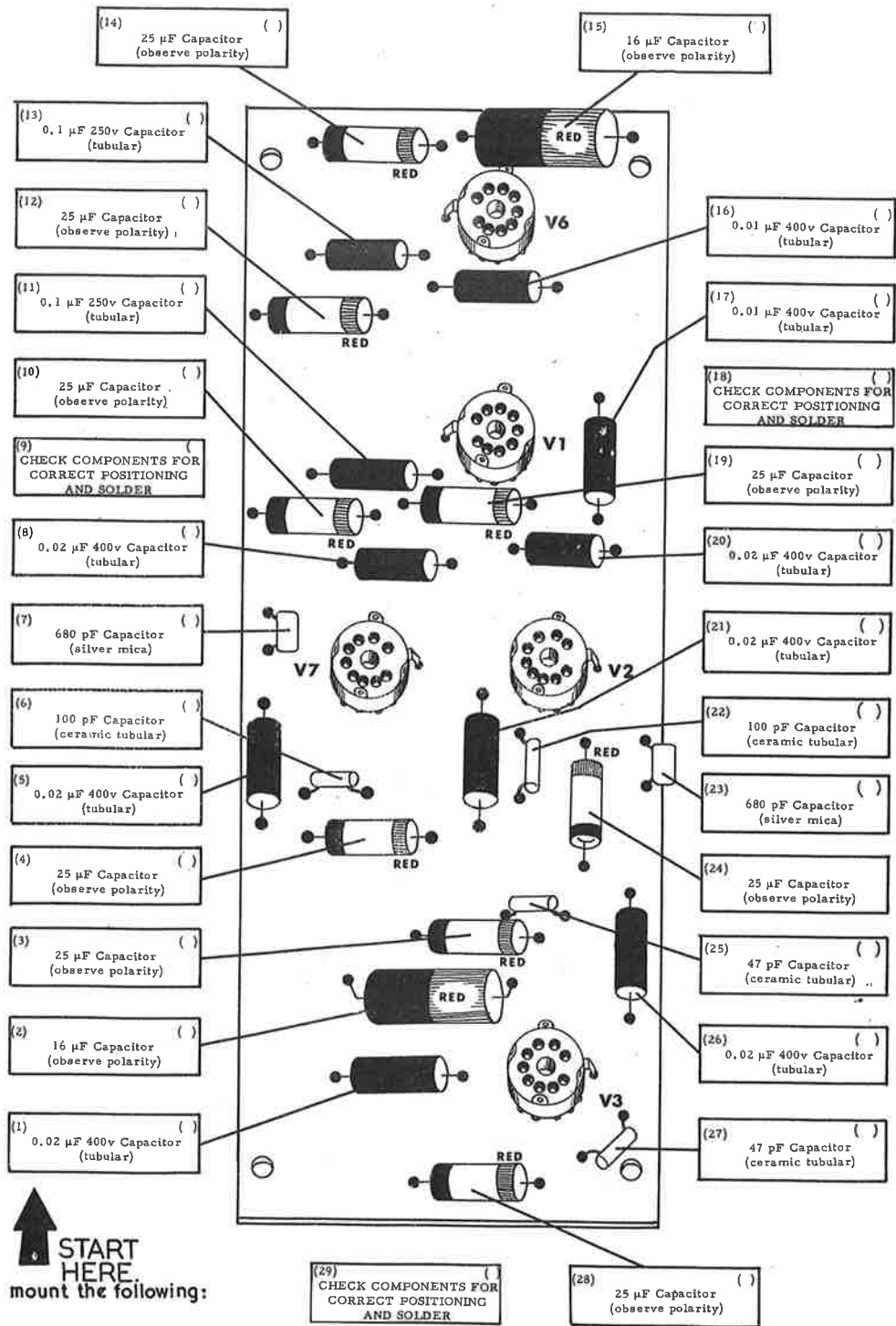

PICTORIAL-9.

PRE-AMPLIFIER CIRCUIT BOARD ASSEMBLY (Stage 2)
SEE PICTORIAL 9

(✓) Continue with the steps shown on Pictorial 9.

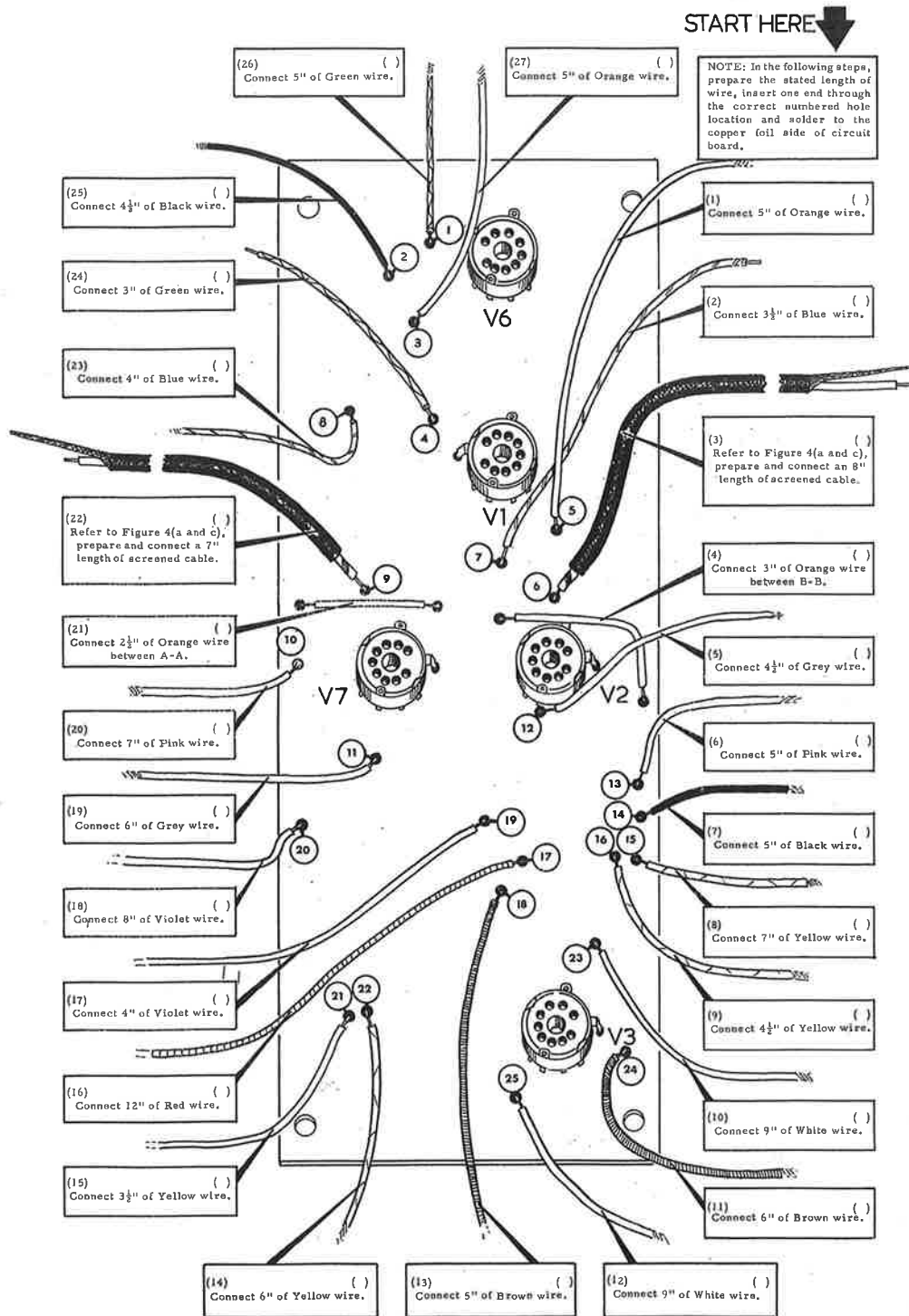

PICTORIAL-10.

PRE-AMPLIFIER CIRCUIT BOARD ASSEMBLY (Stage 3)
SEE PICTORIAL 10

() Continue with the steps shown on Pictorial 10.

The assembly of this circuit board is now completed.

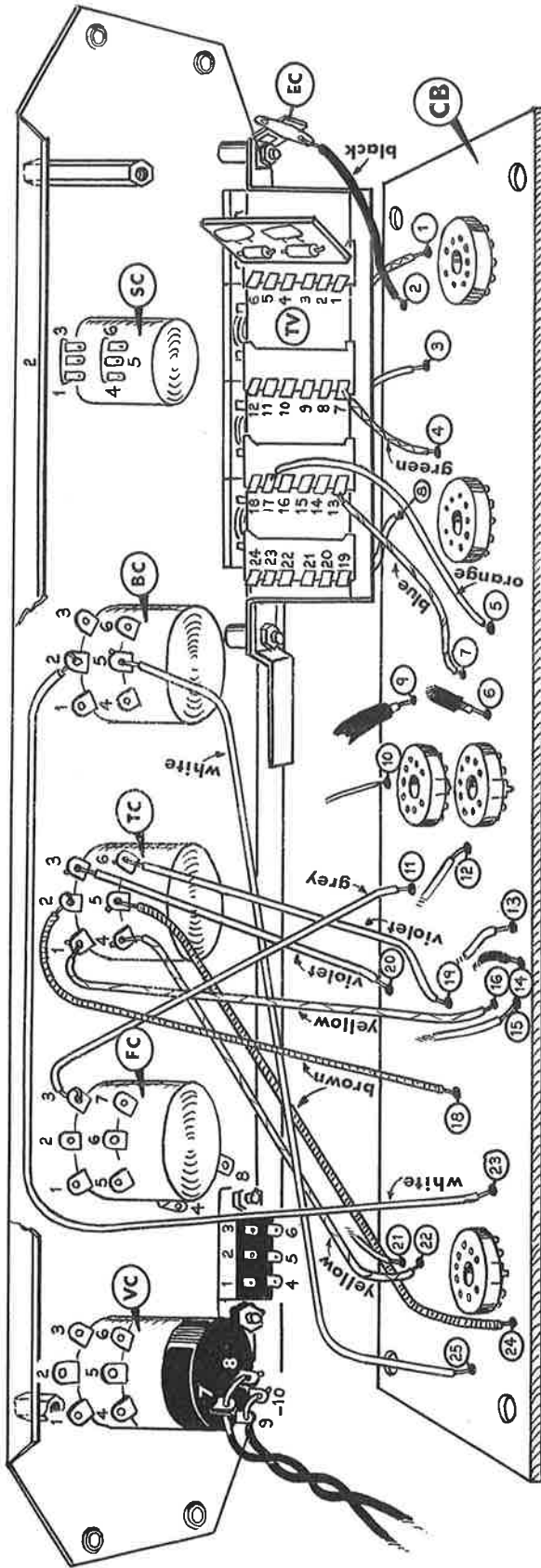

PICTORIAL-IIA

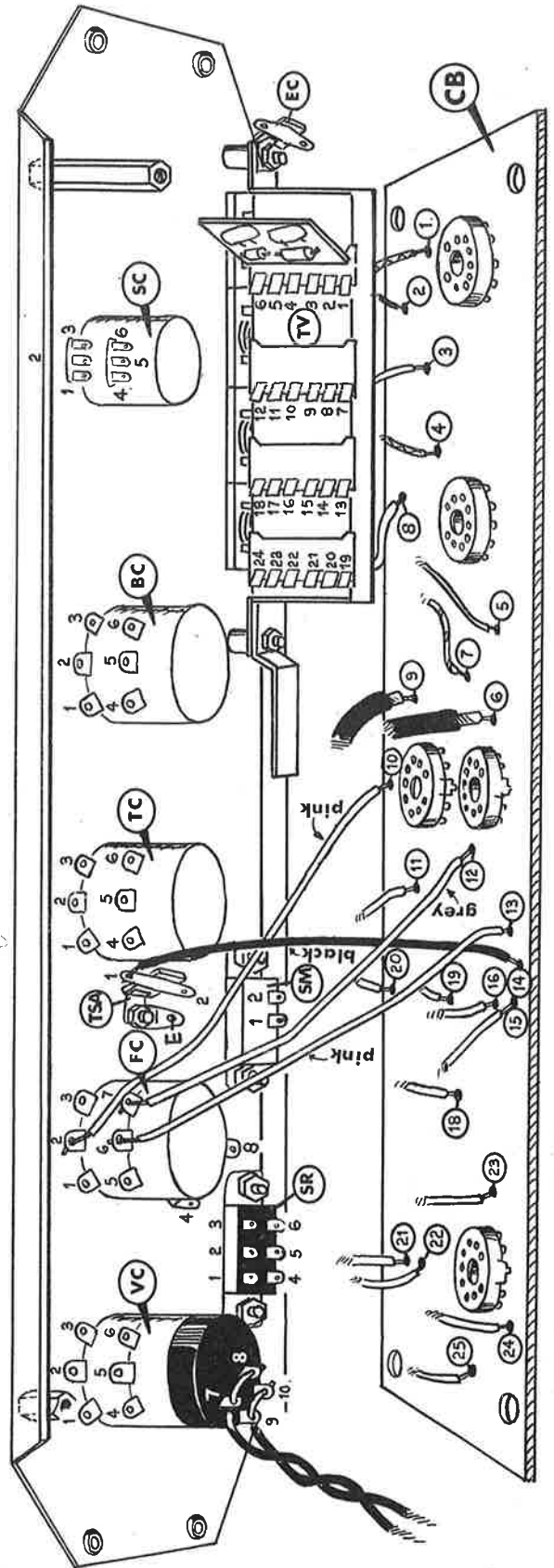

PICTORIAL-II.B

WIRING OF PRE-AMP CIRCUIT TO CONTROLS
SEE PICTORIALS 11 AND 12

- (✓) Select the previously assembled pre-amp circuit board and front panel. Position the front panel as shown in Pictorial 11 and secure the circuit board to the corner pillars with four 4BA x $\frac{1}{4}$ " binderhead screws and lock-washers.

Refer to Pictorial 11A.

- (✓) Connect the GREEN wire from CB4 to TV tag 7 (S-2).
- (✓) Connect the ORANGE wire from CB5 to TV tag 17 (S-2).
- (✓) Connect the BLUE wire from CB7 to TV tag 13 (S-2).
- (✓) Connect the GREY wire from CB11 to FC tag 3 (S-1).
- (✓) Connect the YELLOW wire from CB16 to TC tag 1 (S-2).
- (✓) Connect the BROWN wire from CB18 to TC tag 2 (S-1).
- (✓) Connect the VIOLET wire from CB19 to TC tag 6 (S-3).
- (✓) Connect the VIOLET wire from CB20 to TC tag 3 (S-3).
- (✓) Connect the YELLOW wire from CB22 to TC tag 4 (S-2).
- (✓) Connect the WHITE wire from CB23 to BC tag 2 (S-3). Route this wire along the inside of front panel as shown.
- (✓) Connect the BROWN wire from CB24 to TC tag 5 (S-1).
- (✓) Connect the WHITE wire from CB25 to BC tag 5 (S-3). Route this wire as shown. **CLEAR OF CONTROL V.C.**
- (✓) See Figure 5 and twist together two 15" lengths of BROWN wire.
- (✓) Strip the insulation $\frac{1}{2}$ " at one end of the pair of BROWN wires and connect one wire through VC tag 7 (S-1) to 8 (S-1). Connect the other wire through VC tag 9 (S-1) to 10 (S-1). The other ends will be connected later.

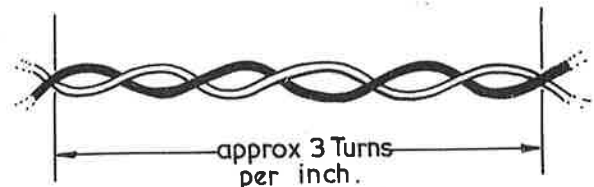

FIGURE-5

Refer to Pictorial 11B.

- (✓) Connect the PINK wire from CB10 to FC tag 2 (S-3).
- (✓) Connect the GREY wire from CB12 to FC tag 7 (S-1).
- (✓) Connect the PINK wire from CB13 to FC tag 6 (S-3).
- (✓) Connect the BLACK wire from CB14 to TSA tag 1 (S-3).

Refer to Pictorial 12.

- (✓) Connect the GREEN wire from circuit board CB1 to the underside of press button switch BV tag 7 (S-2).
- (✓) Connect the BLACK wire from CB2 to EC tag 2 (NS).
- (✓) Connect the ORANGE wire from CB3 to BV tag 17 (S-2).
- (✓) Connect the screened cable from CB6 to stereo/mono switch SM tag 1 (inner wire) (S-1) and braid wire to solder tag E (NS).

X^s and Y^s are not shown on the circuit board. Viewing from the metallized side, the location of these is as shown in the pictorial.

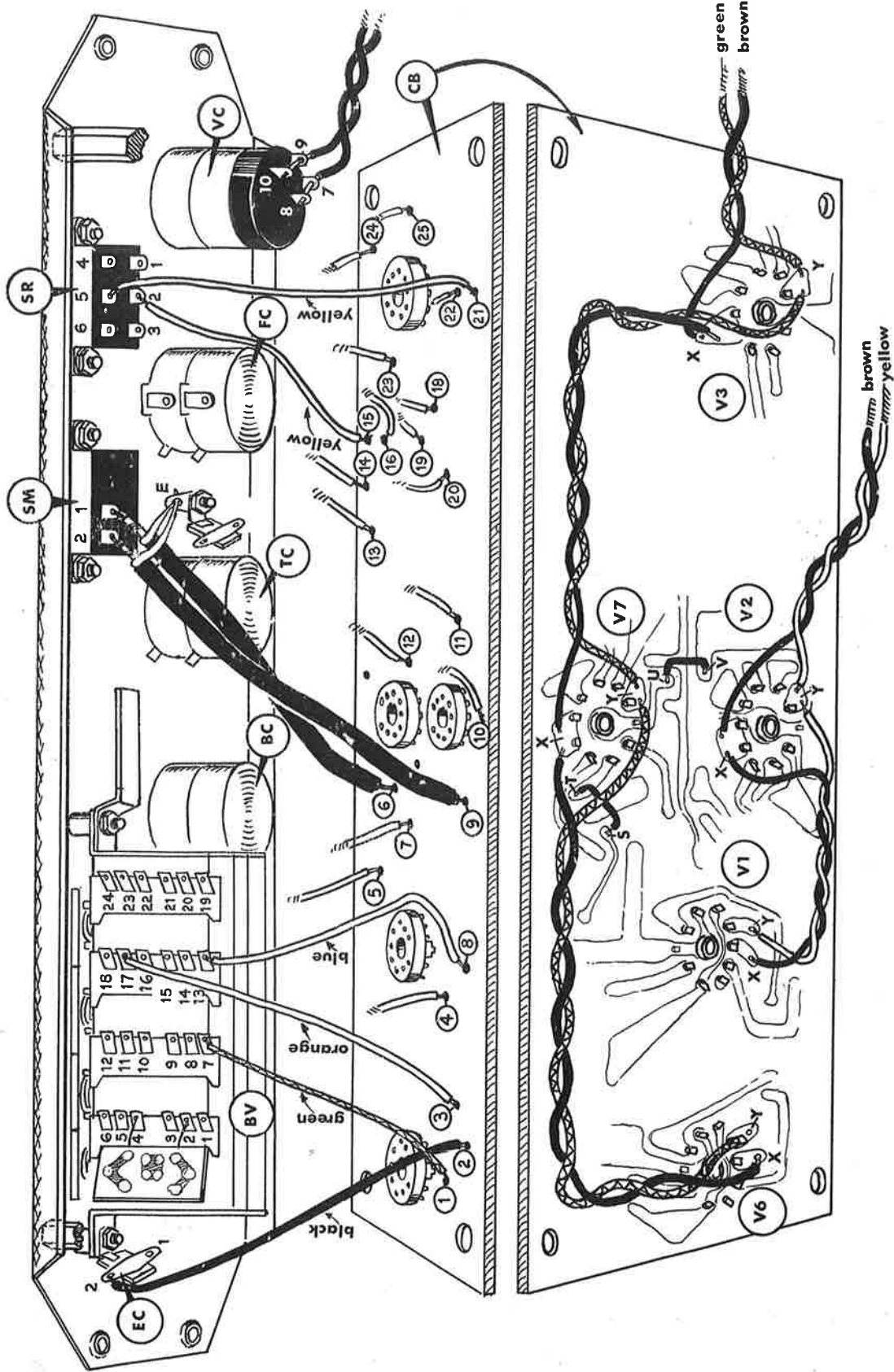

PICTORIAL-12.



- (✓) Connect the screened cable from CB9 to SM tag 2 (inner wire) (S-1) and braid wire to solder tag E (S-2).
- (✓) Connect the BLUE wire from CB8 to BV tag 13 (S-2).
- (✓) Connect the YELLOW wire from CB15 to SR tag 2 (S-1).
- (✓) Connect the YELLOW wire from CB21 to SR tag 5 (S-1).
- (✓) Check all connections between circuit board and front panel controls, the remaining RED wire from CB17 will be connected later.

HEATER WIRING
SEE PICTORIAL 12

NOTE: Insert the following twisted pair of wires in the holes on the copper foil side of the circuit board and solder.

- (✓) Twist together a 7" length of BROWN and GREEN wire.
- (✓) Connect between V6; BROWN to X (S-1), GREEN to Y (S-1) and V7; BROWN to X (S-1), GREEN to Y (S-1).
- (✓) Twist together a 7" length of BROWN and GREEN wire.
- (✓) Connect between V7; BROWN to X (S-1), GREEN to Y (S-1) and V3; BROWN to X (S-1), GREEN to Y (S-1).
- (✓) Twist together a 16" length of BROWN and GREEN wire.
- (✓) Connect one end to V3; BROWN to X (S-1) and GREEN to Y (S-1). Leave the other end free.
- (✓) Twist together a 4½" length of BROWN and YELLOW wire.
- (✓) Connect between V1; BROWN to X (S-1), YELLOW to Y (S-1) and V2; BROWN to X (S-1), YELLOW to Y (S-1).
- (✓) Twist together a 20" length of BROWN and YELLOW wire.
- (✓) Connect one end to V2; BROWN to X (S-1) and YELLOW to Y (S-1). Leave the other end free.
- (✓) Connect a 1" length of BLACK wire between locations U (S-1) and V (S-1), situated between V2 and V7.
- (✓) Connect a 1" length of BLACK wire between location S (S-1) and location T (solder to existing joint).

This sub-assembly is now completed, place to one side until required later.

CHASSIS ASSEMBLY
SEE PICTORIALS 13 AND 14

- (✓) Select the chassis and position as shown in Pictorial 13.
- (✓) Insert 3/8" grommets in holes GB, GC, GD, GF, GH, GK, GL and GM.
- (✓) Mount the 4BA x 5/8" pillars at locations A, B, C, D, E and F with 4BA x ¼" binderhead screws and lockwashers. Finger tighten only.
- (✓) Mount the fuseholder at location FH with two 4BA x ¼" binderhead screws, lockwashers and nuts.
- (✓) Fit the 500 mA fuse in fuseholder FH.
- (✓) Mount the 4-way single fixing tagstrip at location HV with one 4BA x ¼" binderhead screw, lockwasher and nut.
- (✓) Mount the octal valveholder at location RV with the keyway positioned as shown. Use two 4BA x ¼" binderhead screws, lockwashers and nuts.

- (1) Mount the 6-way tagstrip at location LT with a 4BA solder tag at location EG. Secure with two 4BA x $\frac{1}{4}$ " binder-head screws, lockwashers and nuts.
- (2) Select the two output transformers (Part No. 51-507). NOTE: It makes no difference which transformer is used for A or B channels.
- (3) Take one transformer and thread the WHITE, YELLOW, BLUE, RED and BLACK wires through grommet GH and the VIOLET, YELLOW and GREEN wires through grommet GK.
- (4) Mount the transformer to the chassis with two 4BA x $\frac{1}{4}$ " screws, lockwashers and nuts in the holes on either side of grommet GH only. Finger tighten the nuts at this time.
- (5) Mount a 4-way double fixing tagstrip at location LB using the holes on either side of grommet GK and secure with two 4BA x $\frac{1}{4}$ " screws, lockwashers and nuts. These screws also secure the transformer.
- (6) Tighten all four transformer mounting screws.
- (7) Take the other output transformer and thread the WHITE, YELLOW, BLUE, RED and BLACK wires through grommet GL and the VIOLET, YELLOW and GREEN wires through grommet GM.
- (8) In the same manner secure using 4BA x $\frac{1}{4}$ " binderhead screws, lockwashers and nuts in the holes on either side of grommets GL and GM with a 4-way double fixing tagstrip at location LA.
- (9) Select the mains transformer (Part No. 54-529). Remove the four 2BA nuts without disturbing the top shell which holds the voltage selector panel.
- (10) Place the transformer through the chassis cut-out with the coloured leads positioned as shown. Place a 2BA lockwasher over each screw and firmly tighten using the 2BA nuts previously removed.
- (11) Select the 60 + 75 μ F electrolytic capacitor and mounting plate. Insert the prongs of the electrolytic and lock in position by twisting the prongs as shown in Figure 6.
- (12) Mount the 60 + 75 μ F electrolytic capacitor at location SC with the colours positioned as shown. Use two 6BA x $\frac{1}{4}$ " binderhead screws, lockwashers and nuts.
- (13) Select the pre-assembled rear panel and mount it to the rear flange of the chassis with two 4BA x $\frac{1}{4}$ " binderhead screws with a 4BA solder tag at location EB.
- (14) Select and identify the left and right-hand side brackets.
- (15) Refer to Pictorial 14, position the left-hand side bracket and secure as shown with five 4BA x $\frac{1}{4}$ " binderhead screws, lockwashers and nuts.
- (16) Position the right-hand side bracket and secure as shown with five 4BA x $\frac{1}{4}$ " binderhead screws, lockwashers and nuts.
- (17) Dress the screened cables between the side bracket and output transformers.
- (18) Refer to Pictorial 13 and connect the BROWN lead from mains transformer MT to FH tag 1 (S-1). Bend the tag and wire clear of the 4BA nut.
- (19) Connect a 3 $\frac{1}{2}$ " length of BLACK wire between FH tag 2 (S-1) and SC tag 1 (NS). Bend the tags clear of the chassis and 4BA nut.
- (20) Connect the RED flexible wires from MT (wires near BROWN wire), one wire to RV tag 6 (S-1) and the other wire to RV tag 4 (S-1).

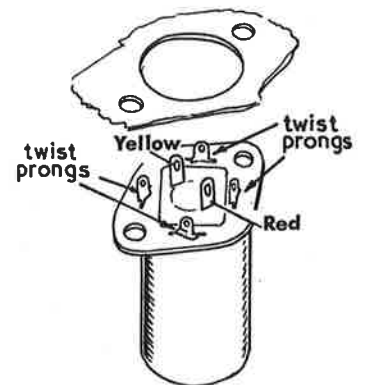
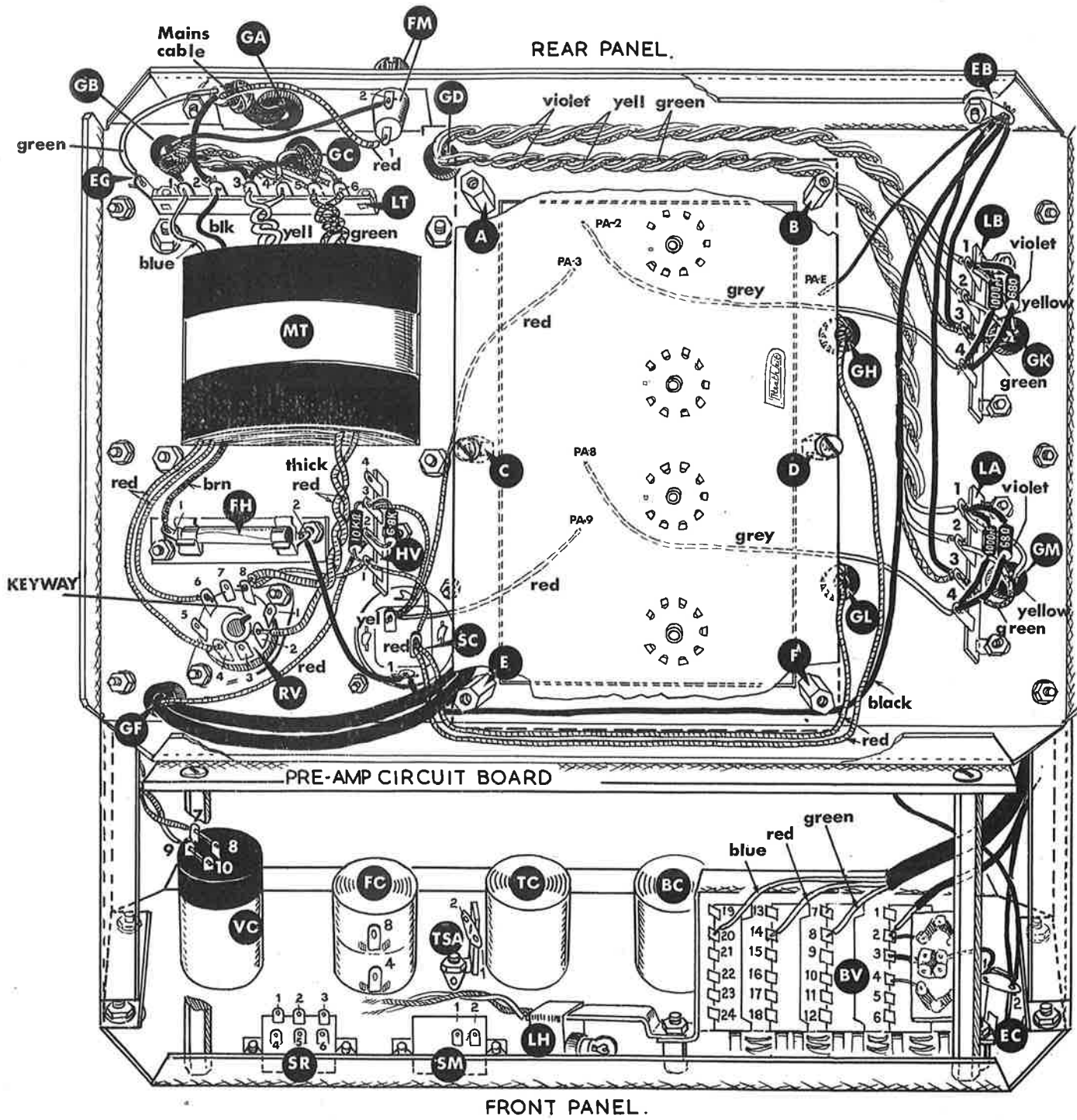

FIGURE 6

- (✓) Connect the thick RED wires from MT, one wire to RV tag 8 (NS) and the other wire to RV tag 2 (S-1).
- (✓) Connect a 2½" length of RED wire between RV tag 8 (S-2) and HV tag 1 (NS).
- (✓) Connect a 1½" length of RED wire between HV tag 1 (NS) and SC RED tag (NS).
- (✓) Connect a 2½" length of RED wire between HV tag 3 (NS) and SC YELLOW tag (NS).
- (✓) Connect the RED wire from grommet GH to SC RED tag (NS).
- (✓) Connect the RED wire from grommet GL to SC RED tag (S-3). } ROUTE AS SHOWN
- (✓) Connect a 10 KΩ 1 watt resistor (BROWN, BLACK, ORANGE) between tags HV1 (S-3) and HV3 (NS).
- (✓) Connect a 6.8 KΩ 1 watt resistor (BLUE, GREY, RED) between tags HV2 (NS) and HV3 (S-3).
- (✓) Connect a 15" length of BLACK wire from SC tag 1 (S-2), route the cable between chassis flange and pillars E and F to solder tag EB (NS).
- (✓) Connect a 4" length of BLACK wire from LB tag 3 (NS) to solder tag EB (NS).
- (✓) Connect a 7" length of BLACK wire from LA tag 3 (NS) to solder tag EB (NS).
- (✓) Twist together a 14" length of GREEN, YELLOW and VIOLET wire.
- (✓) Connect one end of the three wires; VIOLET to LB tag 1 (NS), YELLOW to LB tag 2 (NS) and GREEN to LB tag 3 (NS). Route the wires between chassis flange and pillars PB and PA and through grommet GD.
- (✓) Refer to Pictorial 14, turn the chassis over and connect the wires from grommet GD; VIOLET wire to ^{OA} tag 1 (S-1), YELLOW wire to ^{OA} tag 2 (S-1) and GREEN wire to ^{OA} tag 3 (S-1).
- (✓) Refer to Pictorial 13 and carefully shorten the VIOLET, YELLOW and GREEN wires coming through grommet GK to 2".
- (✓) Connect the wires from grommet GK; VIOLET wire to LB tag 1 (NS), YELLOW wire to LB tag 2 (S-2) and GREEN wire to LB tag 3 (S-3).
- (✓) Using 5/8" sleeving at each end, connect a 680Ω resistor (BLUE, GREY, BROWN) between LB tag 1 (NS) and LB tag 4 (NS).
- (✓) Using ½" sleeving at each end, connect a 1000 pF silver mica capacitor between LB tag 1 (S-4) and LB tag 4 (NS).
- (✓) Twist together an 18" length of GREEN, YELLOW and VIOLET wire.
- (✓) Connect one end of the three wires; VIOLET to LA tag 1 (NS), YELLOW to LA tag 2 (NS) and GREEN to LA tag 3 (NS). Route the wires between chassis flange and pillars PB and PA and through grommet GD.
- (✓) Refer to Pictorial 14, turn the chassis over and connect the wires from grommet GD; VIOLET wire to ^{OB} tag 1 (S-1), YELLOW wire to ^{OB} tag 2 (S-1) and GREEN wire to ^{OB} tag 3 (S-1).
- (✓) Refer to Pictorial 13 and carefully shorten the VIOLET, YELLOW and GREEN wires coming through grommet GM to 2".
- (✓) Connect the wires from grommet GM; VIOLET wire to LA tag 1 (NS), YELLOW wire to LA tag 2 (S-2) and GREEN wire to LA tag 3 (S-3).
- (✓) Using 5/8" sleeving at each end, connect a 680Ω resistor (BLUE, GREY, BROWN) between LA tag 1 (NS) and LA tag 4 (NS).
- (✓) Using ½" sleeving at each end, connect a 1000 pF silver mica capacitor between LA tag 1 (S-4) and LA tag 4 (NS).



PICTORIAL-13

- (✓) Connect the BLUE wire from transformer MT to tagstrip LT tag 1 (NS).
- (✓) Connect the BLACK wire from MT to LT tag 2 (NS).
- (✓) Take the YELLOW wires from MT and connect one wire to LT tag 2 (NS) and the other wire to LT tag 4 (NS).
- (✓) Take the GREEN wires from MT and connect one wire to LT tag 5 (NS) and the other wire to LT tag 6 (NS).
- (✓) Select the front panel assembly and mount it on the side brackets using 4BA x 1/4" binderhead screws, lockwashers and nuts.
- (✓) Route the RED wire from pre-amp circuit board location 17 through grommet GF and connect this end to HV tag 2 (S-2).
- (✓) Take the BROWN wires previously connected to VC tags 7, 8, 9 and 10 and route along side bracket and through grommet GB.
- (✓) Connect one BROWN wire to LT tag 1 (S-2) and the other BROWN wire to fuseholder FM tag 2 (S-1).
- (✓) Take the YELLOW and BROWN wires previously connected to pre-amp circuit board and route them along the side bracket and through grommet GB.
- (✓) Connect the YELLOW and BROWN wires coming through grommet GB; YELLOW wire to LT tag 4 (NS) and BROWN wire to LT tag 3 (NS).
- (✓) Take the GREEN and BROWN wires previously connected to pre-amp circuit board and route them along the side bracket and through grommet GB.
- (✓) Connect the GREEN and BROWN wires coming through grommet GB; GREEN wire to LT tag 6 (NS) and BROWN wire to LT tag 5 (NS).
- (✓) Twist together a 10" length of GREEN and BROWN wire.
- (✓) Connect one end; BROWN wire to LT tag 5 (S-3) and GREEN wire to LT tag 6 (S-3). Route the other end through grommet GC and connect BROWN wire to HA tag 3 (NS) and GREEN wire to HA tag 1 (NS).
- (✓) Twist together a 9" length of YELLOW and BROWN wire.
- (✓) Connect one end; BROWN wire to LT tag 3 (S-3) and YELLOW wire to LT tag 4 (S-3). Route the other end through grommet GC and connect the BROWN wire to HB tag 3 (NS) and YELLOW wire to HB tag 1 (NS).
- (✓) Refer to Pictorial 13. Select the pre-assembled power amplifier circuit board and mount with the foil side uppermost to chassis on the six 5/8" pillars. Note that the valveholders are off-centre to the right. Secure with six 4BA x 1/4" binderhead screws.
- (✓) Tighten the 4BA screws at the chassis end of the 5/8" pillars.

NOTE: Power amplifier circuit board connections, reference PA.

- (✓) Connect the RED wire from PA3 to SC YELLOW tag (NS).
- (✓) Connect the RED wire from PA9 to SC YELLOW tag (S-3).
- (✓) Connect the BLACK wire from PA-E to solder tag EB (S-4).
- (✓) Connect the GREY wire from PA2 to LB tag 4 (S-3).
- (✓) Connect the GREY wire from PA8 to LA tag 4 (S-3).
- (✓) Carefully shorten the WHITE, YELLOW, BLUE and BLACK wires coming through grommets GH and GL to 3 1/2".

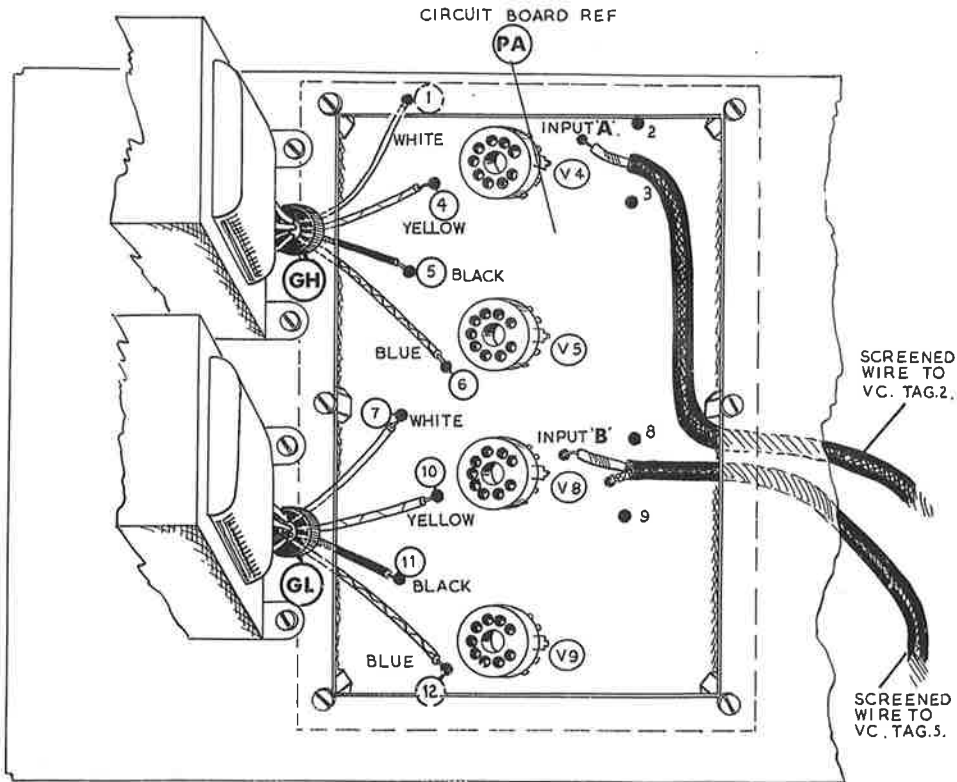

FIGURE-7.

NOTE: Refer to Figure 7 for the following 8 steps:-

- (✓) Connect the WHITE wire from grommet GH to PA-1 (S-1).
- (✓) Connect the YELLOW wire from grommet GH to PA-4 (S-1).
- (✓) Connect the BLACK wire from grommet GH to PA-5 (S-1).
- (✓) Connect the BLUE wire from grommet GH to PA-6 (S-1).
- (✓) Connect the WHITE wire from grommet GL to PA-7 (S-1).
- (✓) Connect the YELLOW wire from grommet GL to PA-10 (S-1).
- (✓) Connect the BLACK wire from grommet GL to PA-11 (S-1).
- (✓) Connect the BLUE wire from grommet GL to PA-12 (S-1).
- (✓) Route the screened wire from input 'B' through grommet GF and connect inner wire to VC tag 2 (S-1) with braid wire to bare wire link (S-1). See Pictorial 13 and Figure 8.
- (✓) Route the screened wire from input 'A' through grommet GF and connect inner wire to VC tag 5 (S-1) with braid wire to bare wire link (S-1). See Pictorial 13 and Figure 8.

Refer to Pictorial 14 for the following steps:-

- (✓) Connect the GREEN and BROWN wires from circuit board PA; BROWN wire to HA tag 3 (S-2) and GREEN wire to HA tag 1 (S-2).

* References VC tag 2 and VC tag 5 are shown reversed in Fig 7

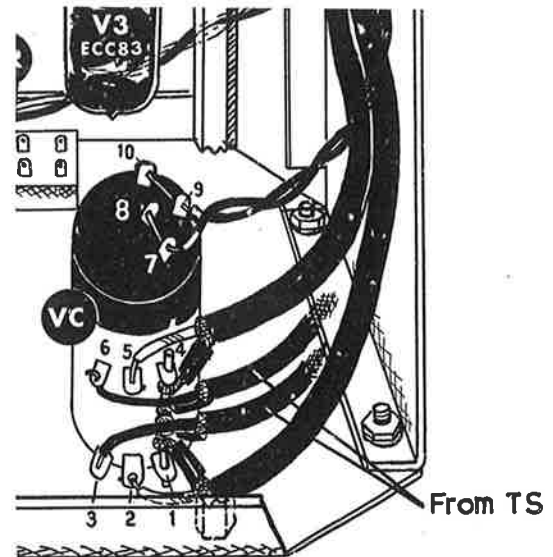
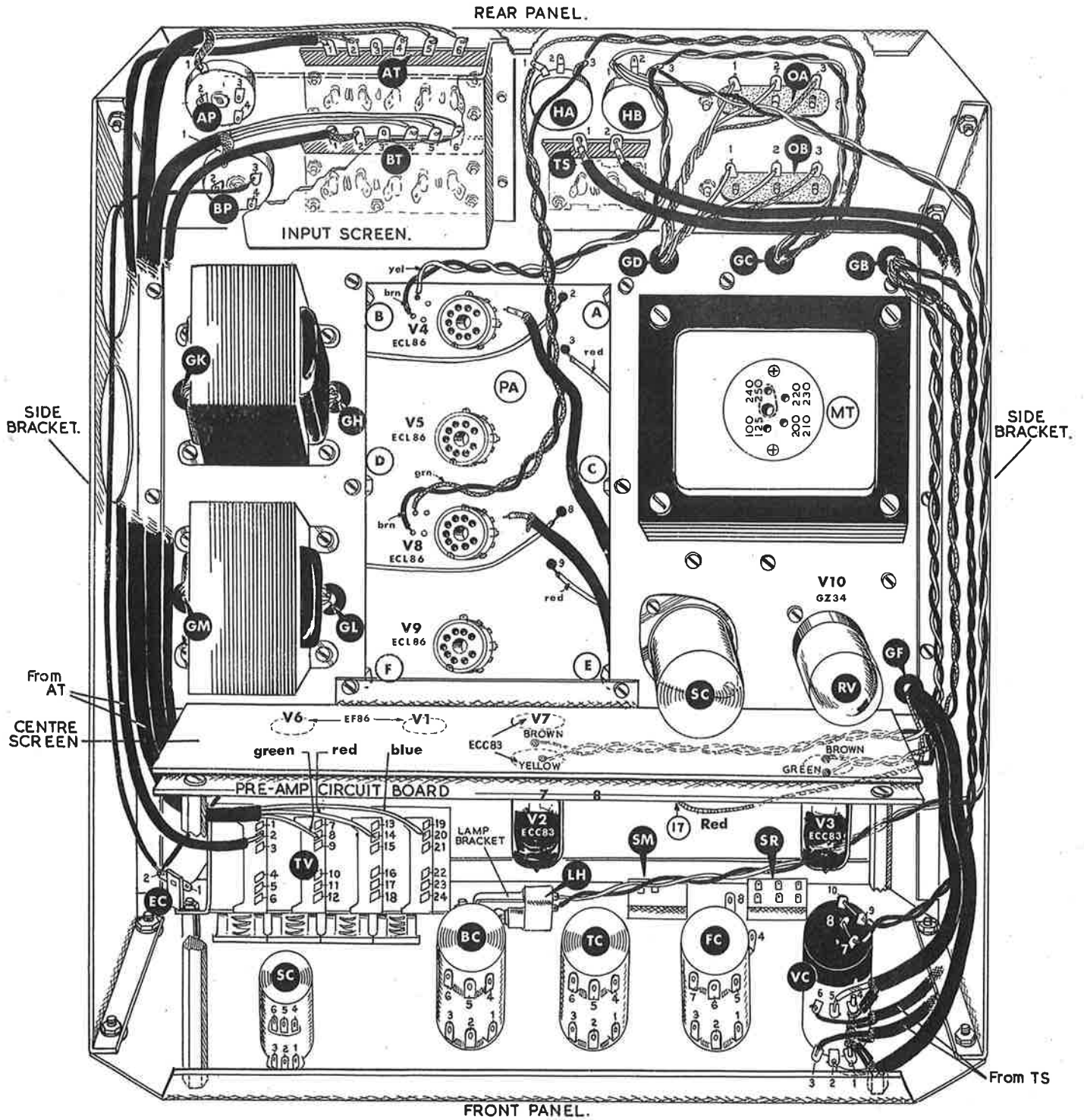
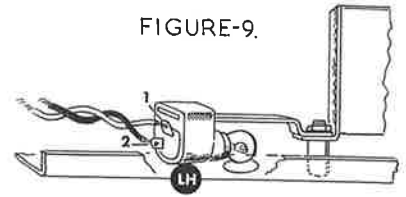

FIGURE-8.



- () Connect the YELLOW and BROWN wires from circuit board PA; BROWN wire to HB tag 3 (NS) and YELLOW wire to HB tag 1 (NS).
- (✓) Twist together a 24" length of BROWN and YELLOW wire as shown in Figure 5.
- (✓) Refer to Figure 9 and connect one end to the lampholder; BROWN wire to LH tag 1 (S-1) and YELLOW wire to LH tag 2 (S-1).
- (✓) Take the 6.3v lamp and screw it into the lampholder.
- (✓) Slide the lampholder on the lampbracket and position with the glass bulb opposite the hole in the front panel. Route the other end of the wire along the side bracket to control HB as shown in Pictorial 14.
- (✓) Connect the BROWN wire to HB tag 3 (S-3) and the YELLOW wire to HB tag 1 (S-3).
- (✓) Prepare two 19" lengths of single screened cable as shown in Figures 4(a and c).
- (✓) Refer to Pictorial 14 and Figure 8 and connect one length of prepared cable, inner wire to VC tag 3 (S-2) with braid wire to bare wire link (S-1). Route this cable along the bottom flange of the side bracket and connect the free end to TS tag 1 (S-2).
- (✓) Connect the other length of prepared cable, inner wire to VC tag 6 (S-2) with braid wire to bare wire link (S-1). Route this cable along the bottom flange of the side bracket and connect the free end to TS tag 2 (S-2).
- (✓) Identify the single core screened cable previously connected to AT tag 1 and connect the other end to TV tag (S-2).
- (✓) Refer to Pictorial 14 and identify the three-core screened cable previously connected to AT tags 4, 5 and 6. Connect the other end; GREEN wire to press button switch TV tag 8 (S-2), RED wire to TV tag 14 (S-1) and BLUE wire to TV tag 20 (S-1).
- (✓) Connect the BLACK wire from BP tag 3 to EC tag 2 (S-2).
- (✓) Refer to Pictorial 13 and 14. Identify the three-core screened cable previously connected to BT tags 4, 5 and 6 and then turn the chassis over and connect the GREEN wire to BV tag 8 (S-2), RED wire to BV tag 14 (S-1) and BLUE wire to BV tag 20 (S-1).
- (✓) Identify the single core screened cable previously connected to BT tag 1 and connect the other end to BV tag 2 (S-2).
- (✓) Take the length of 3-core mains cable and remove $2\frac{1}{2}$ " of the outer cotton insulation from each end. Tape each end to prevent fraying.
- (✓) Thread one end of the 3-core cable through grommet GA and tie a knot 3" from the end for strain relief.
- (✓) Connect the GREEN mains cable wire to solder tag EG (S-1).
- (✓) Connect the BLACK mains cable wire to LT tag 2 (S-2).
- (✓) Connect the RED mains cable wire to fuseholder FM tag 1 (S-1).
- (✓) Carefully inspect all soldered joints, resoldering any that appear to be badly made.
- (✓) See Pictorial 14 and determine the voltage of your mains supply. Insert the 2-pin voltage selector plug in the nearest voltage tapping on the selector panel of the mains transformer.
- (✓) Locate the Input Screen and position at the rear of the input sockets. Secure with two 6BA x $\frac{1}{4}$ " binderhead screws into the threaded bushes of the screen. Make sure that the input tags are not touching the screen.
- (✓) Locate the large centre screen. Remove the two front screws holding the power amplifier circuit board and place the screen in position. Replace and tighten screws.

FIGURE-9.



IMPORTANT WARNING: MINIATURE VALVES CAN BE EASILY DAMAGED WHEN INSTALLING THEM IN THEIR SOCKETS. THEREFORE, USE EXTREME CARE WHEN INSTALLING.

- (4) Install all valves at locations shown in Pictorial 14. The valve type numbers appear near each valve socket on the circuit boards.
- (5) *It is now important to adjust the positioning of any leads which are now near the four ECL56 valves of heat when running*
 FINAL ASSEMBLY
 SEE PICTORIAL 15 *to be at least 1/4" clear because*
- (6) Locate the length of foam plastic and with a sharp knife, cut it in half along its length.
- (7) Remove the paper backing from each strip and stick the adhesive side of each strip to the metal front panel as shown.

Black areas foam rubber strip.

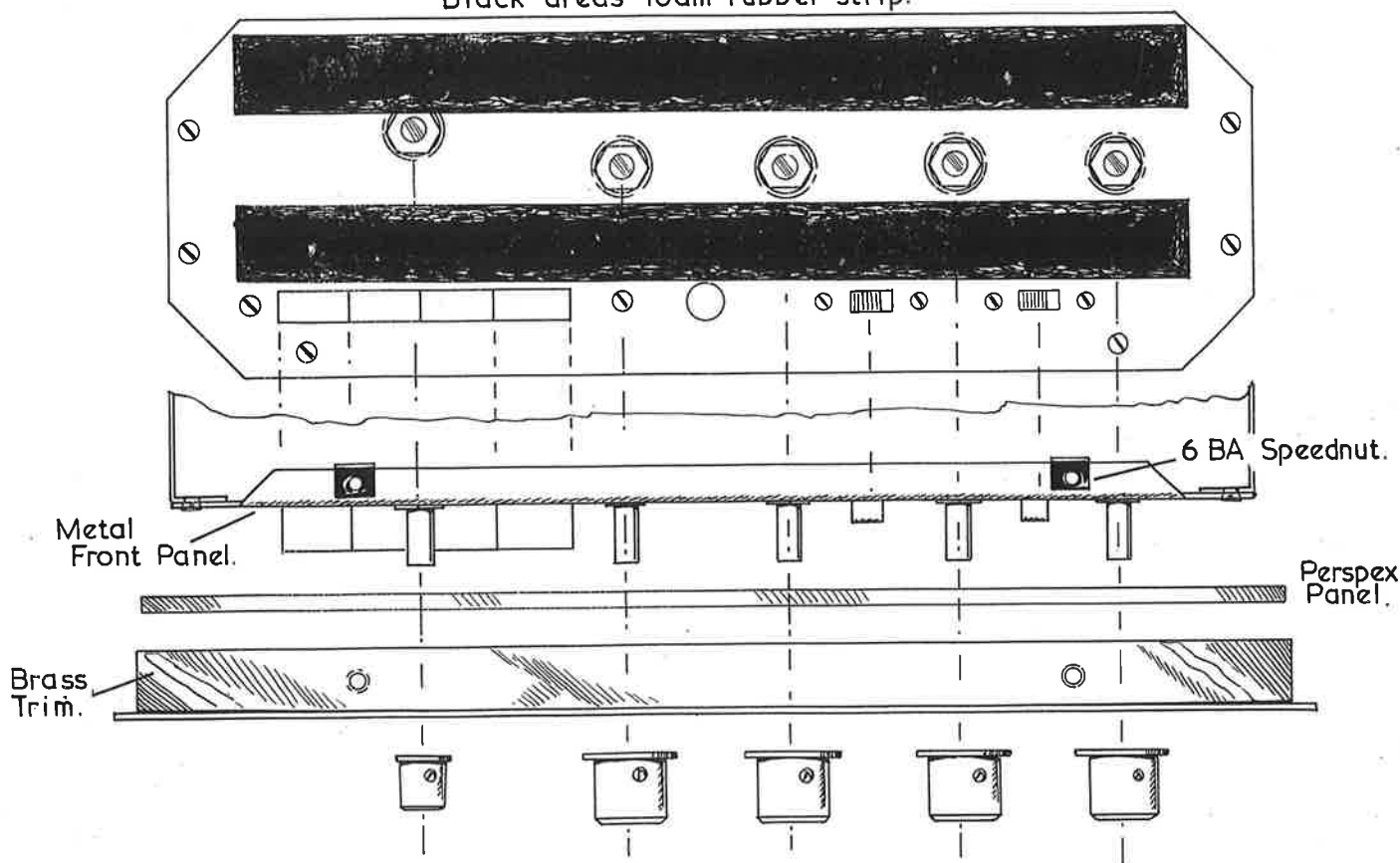

PICTORIAL-15.

- (✓) Locate the four 6BA speed nuts and clip them on the metal front panel. The turned-up edge must fit inside the panel flange.
- (✓) Locate the brass frame and perspex front panel and place the panel inside the brass frame with the joint section at the bottom.
- (✓) Mount the brass frame on the metal control panel and secure in each corner with 6BA x 5/16" countersunk head screws. The 6BA speed nuts may be adjusted to align with the four countersunk holes on the brass frame.
- (✓) Make sure the mains switch on the volume control is in the OFF position.
- (✓) Place the four large knobs on the control shafts for the bass, treble, filter and volume controls and the small knob on the balance control. Do not tighten the grub screws.

NOTE: (1) When tightening the grub screws, apply moderate pressure otherwise the knob will be damaged. (2) The controls supplied may cover a slightly wider angle than that printed on the perspex panel.

- (✓) Set the knob pointer on the volume control shaft to the OFF position and tighten grub screw.
- (✓) Turn the filter control shaft fully clockwise, set the knob pointer to the LIN position and tighten the grub screw.
- (✓) Adjust the treble control shaft to its mid-position, set the knob pointer to '12 o'clock' and tighten the grub screw.
- (✓) Adjust the bass control shaft to its mid-position, set the knob pointer to '12 o'clock' and tighten the grub screw.
- (✓) Adjust the balance control shaft to its mid-position. Set the pointer to '12 o'clock', tighten the grub screw.

FITTING OF CABINET
SEE PICTORIAL 16

- (✓) Mount the four rubber feet on the cabinet using a 2BA x 1/2" screw, flatwasher, lockwasher and 2BA half-nut as shown in Figure 10.

Do not over-tighten

Input Cable Assembly

NOTE: All input connections to this amplifier must be made with screened cable of the same type as that used for the internal wiring. The cables should not be made longer than required.

- () Refer to Figure 11 and make the required input cables.

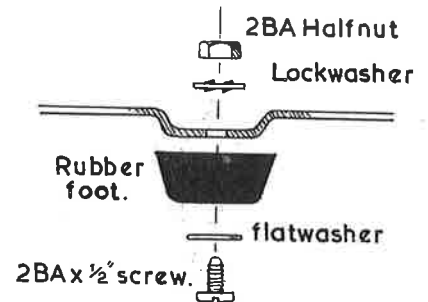
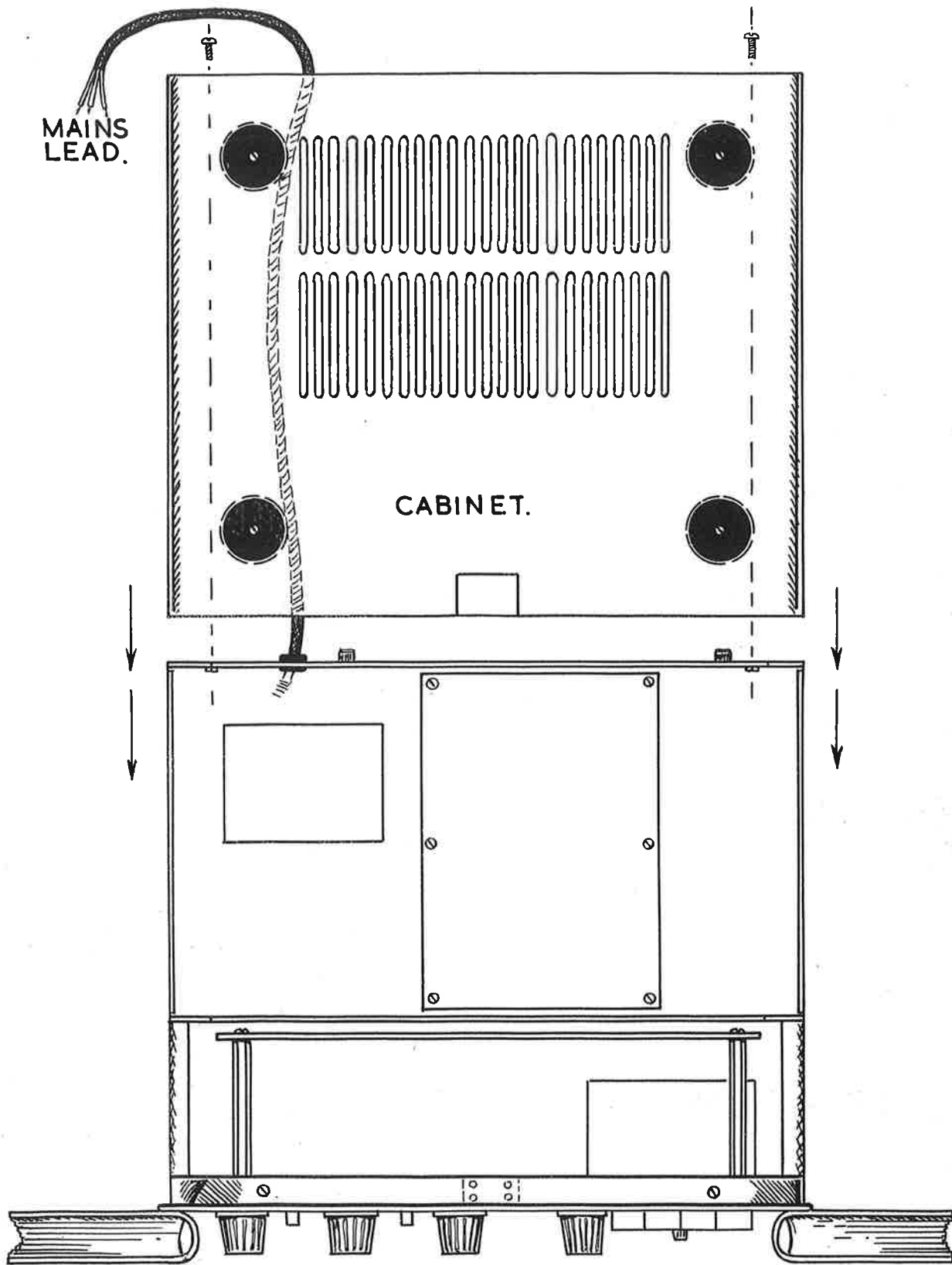

FIGURE -10



FIGURE-11



PICTORIAL-16.

INITIAL TESTING

- () Connect two pairs of wires from your loudspeaker system to the output sockets marked O, 3 or 15 ohms. See 'speaker phasing' on Page 46.
- () Set the front panel controls as follows:

Volume	OFF
Bass	'12 o'clock'
Treble	'12 o'clock'
Balance	'12 o'clock'
Filter	at LIN
Mono/Stereo	at STEREO
Normal/Reverse	at NORMAL
Press Button	on Radio

- () Adjust the GRAM input level controls to their fully clockwise position as viewed from the rear.
- () Adjust the HUM BALANCE controls to their mid-position.
- () Connect a suitable mains plug on the end of the mains cable.

GREEN to Large earth pin (E)
 RED to Line pin (L)
 BLACK to Neutral pin (N)

This code is usually marked on the plug.

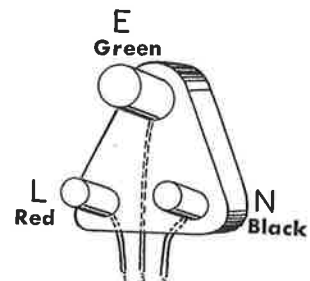

DETAIL-1.

- () Plug into your mains supply and switch on the amplifier at the volume control. Turn the control fully clockwise.
- () The 6.3v lamp should now light and also all the valve heaters. Some valves light very brightly when first switched on. This is normal. It may be difficult to see the heaters of the EF86 valves.
- () If any valve or other component show signs of overheating, immediately switch OFF and refer to the section IN CASE OF DIFFICULTY.
- () If no overheating occurs, switch the amplifier OFF and disconnect the mains plug and speaker wires.
- () Carefully fit the cabinet on the chassis as shown in Pictorial 16.
- () Reconnect the speaker wires and mains plug. Switch on and set the volume control to position '3'.

Perform the following steps to determine if the amplifier is operating normally.

- () Insert a narrow blade screwdriver (or similar metal probe such as a short length of solder, a bent paper clip etc.) in channel A Radio input socket, so that it touches the inner contact.
 While holding the inserted probe, slowly advance the volume control, a loud hum should be heard from one speaker.
- () Transfer the probe to channel B Radio input, a loud hum of equal intensity should now be heard in the other speaker.
- () In the same manner repeat the above tests for inputs Tape, Aux, PU-1 and PU-2, changing the press button switch to the appropriate input.
- () If you are satisfied that both channels of the amplifier are operating normally, proceed to the sections INSTALLATION and OPERATION.

INSTALLATION

The S-99 amplifier may be operated in the open or, if desired, mounted in an equipment cabinet. For cabinet mounting the four rubber feet are removed and it is recommended that the rear of the amplifier be supported on a 2" x 1" wood batten and secured with clamp brackets as shown in Figure 12.

A template is provided for the front panel cut-out, (Figure 13, loose leaf).

Since heat is generated in nearly all electronic equipment, adequate ventilation must be provided. At least 4" of open space above and 1" below the amplifier's metal cabinet is considered minimum for proper air circulation. DO NOT mount the amplifier in the vertical position or overheating will result.

Figure 14 and 15 show typical high fidelity stereo installations. These are provided as examples and should be used as a guide only. There are other combinations of equipment that will provide equally good results.

INPUT and OUTPUT connections:

Screened cables terminated in the appropriate type plugs must be used to make all low level input and output signal connections to the S-99 Stereo Amplifier (see Figure 11). Two-coloured twin flex (14/.0076") is ideal for the loudspeaker connections. Separate input sockets are provided for each channel and changing of the STEREO-MONO switch to MONO will parallel the two amplifiers thus bringing both speakers into operation when a mono programme source is used.

RADIO - Input for FM and AM tuners.

TAPE - Input for playing back tape from a complete tape recorder.

AUX. - Input for use with high impedance microphones and crystal pick-ups.

PICK-UP NO. 2 - Input for crystal and ceramic pick-ups such as the Decca 'Derram' and Acos 'High-light' matched to provide a velocity response.

PICK-UP NO. 1 - Input for all magnetic pick-ups such as the Decca ffss, E. M. I. EPU/100, SHURE, A.D.C., B and O, etc.

TAPE RECORDER - Output for recording via a complete tape recorder, signals from all inputs.

3 AND 15 OHM OUTPUT - For connecting to external speaker system, nominal impedance 3 or 15 ohms.

OPERATION

Input Levels

After making all input connections, each input should be adjusted to give approximately equal volume levels as the push buttons are depressed. NOTE: For low output magnetic pick-ups including those mentioned above, the 'gram' pre-set input controls must be turned to 'max'.

() Depress GRAM input button.

() Switch on and set the VOLUME control to position 9.

() Play a suitable stereo record and adjust the rear panel pre-set level controls for pick-up 1 or pick-up 2 to a slightly higher than normal listening level. Adjust one control until a balance is obtained. Final balance being made with the front panel BALANCE control.

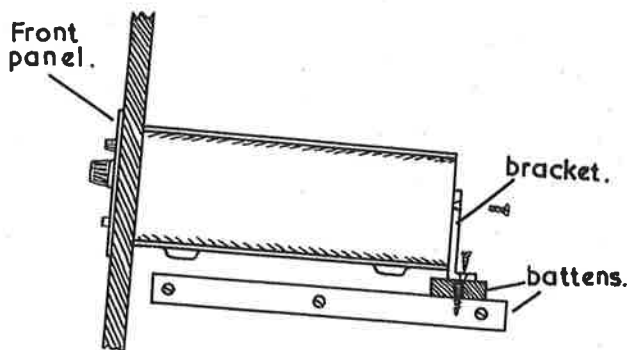
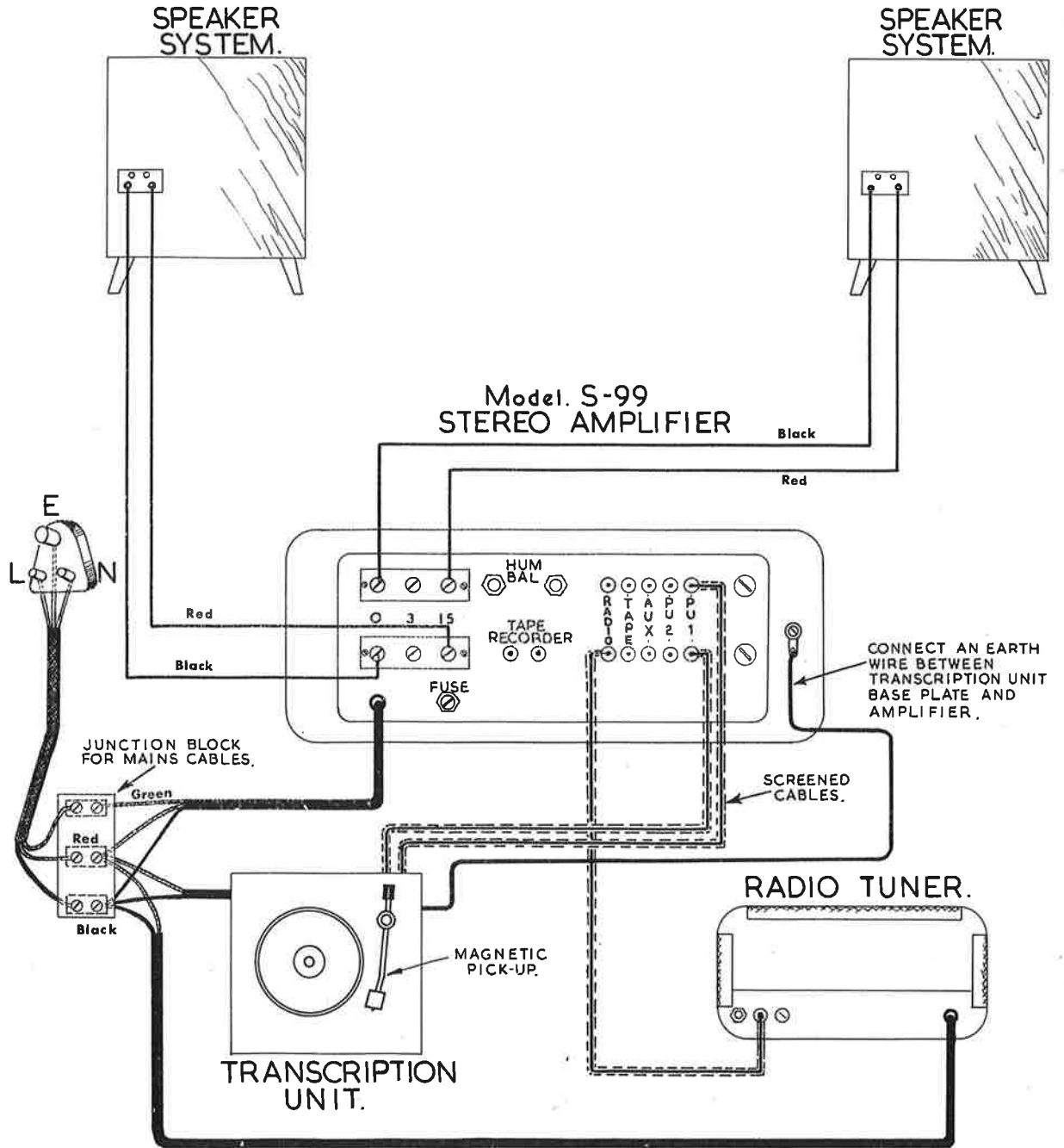

FIGURE-12.

NOTE: The pre-set level controls are provided on GRAM inputs to prevent possible overloading of the early stage in the amplifier. The same control operates on pick-up 1 and pick-up 2 for each channel.

Other signal inputs such as AM and FM tuners usually have their own pre-set controls and these should be adjusted so that maximum volume is obtained with the amplifier volume control set at position 9.



TYPICAL INSTALLATION. FIGURE-14

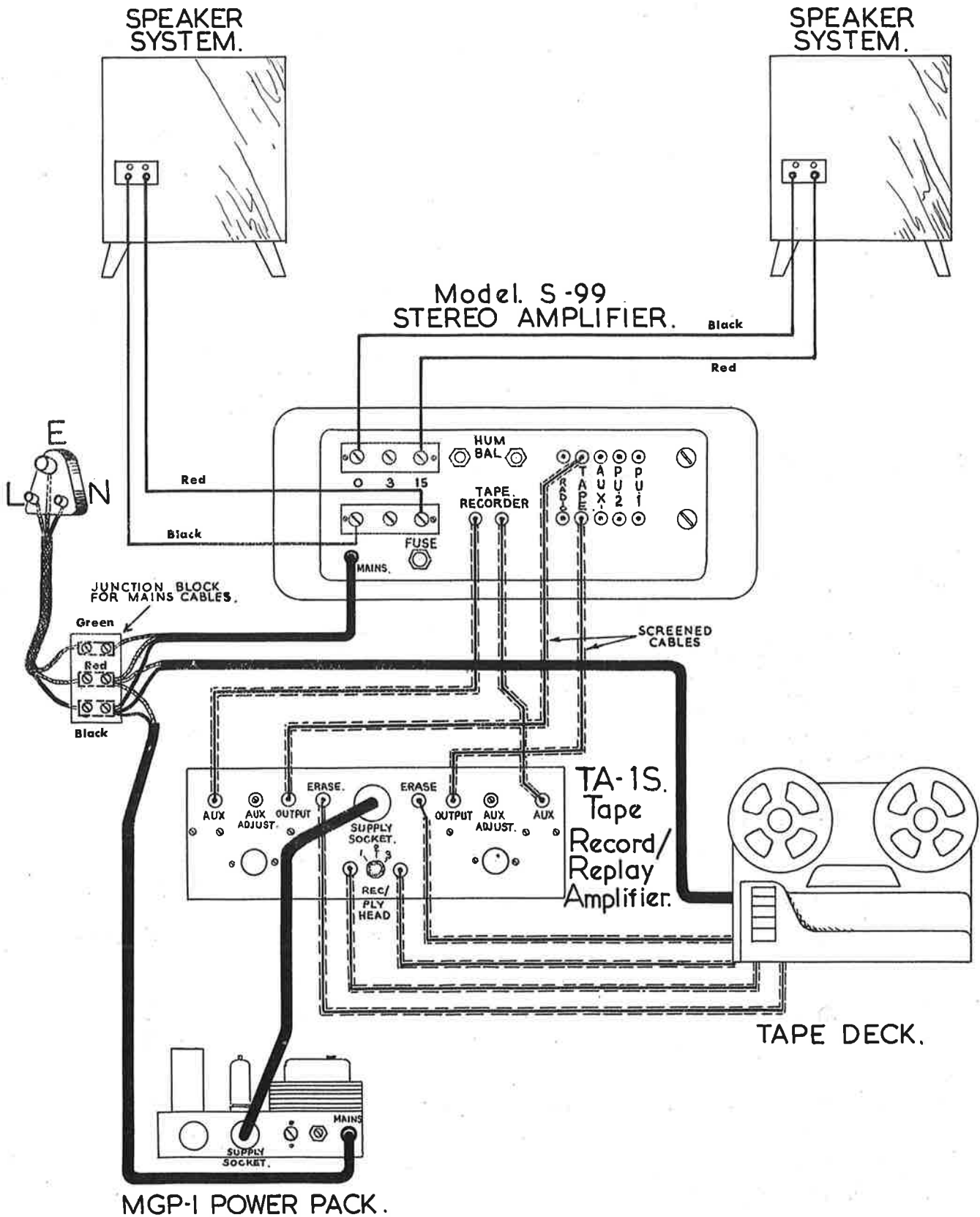

TYPICAL INSTALLATION. FIGURE-15.



FRONT PANEL CONTROLS

Volume - Dual-tandem control, allowing the listening level of both channels to be adjusted simultaneously.

Bass and Treble - Dual-tandem controls, allowing the bass and treble response of both channels to be adjusted simultaneously.

4-Pushbutton Switch - Selects the signal inputs connected to the rear panel. Depressing any one of the four push buttons automatically disengages the one previously depressed. To prevent "loudspeaker clicks" the volume should be decreased before operating.

Balance - Reversed log law dual-tandem control. Turning the control either way from the '12 o'clock' position decreases the level of one channel without audibly effecting the other.

Low Pass Filter - Continuously variable to 4 Kc/s; used to reduce the surface noise of worn records etc. by providing a smooth frequency cutoff above the operating point. See Graph 4 on Page 5.

Channel Reverse - Two-position slide switch permitting instant changeover between channels. When the channel reverse switch is in the NORMAL position, the external stereo connections should be such that the LEFT (A) channel feeds the LEFT (A) channel speaker as viewed when facing speakers. The reverse position is used to correct stereo material which might be reversed.

Mono/Stereo - Two-position slide switch, providing either STEREO or MONO mode of operation. When in the MONO position, the left and right channels are connected together, this enables monaural sources such as radio or mono records to be reproduced over both speakers.

OPERATING NOTES

Hum Balance - Adjust the screwdriver slot controls on the rear panel for minimum hum from the speaker of each channel with the push button switch in the GRAM position and the pick-up connected.

Earthing - The whole installation should be connected to earth at ONE POINT only. This should be via the GREEN lead of amplifier's mains cable.

Other equipment will be earthed to the amplifier via the screened interconnecting cable.

NOTE: If one or more sections of the equipment are independently earthed, it will cause a 'Hum Loop' and mains hum will be heard from the speakers.

Speaker Phasing - The two speakers should be connected to the amplifier so that they are 'in phase'. This means that all speaker cones move in the same direction at the same time.

Correct speaker phasing can be obtained in the following manner when using Heathkit speakers:

- (1) Connect a BLACK wire between the amplifier terminal O and the speaker BLACK terminal.
- (2) Connect a RED wire between the amplifier 15 ohm terminal and the speaker RED terminal.
- (3) Repeat the above for the other speaker using separate wires.

NOTE: If the two loudspeakers are not 'in phase' there will be a noticeable loss of bass and the sound will appear to come from two separate sources instead of from the whole area between the speakers.

IN CASE OF DIFFICULTY

1. Recheck all wiring. It is frequently helpful to have a friend check your work. Someone who is not familiar with the unit may notice a mistake or bad joint consistently overlooked by the constructor.
2. Check that valves are in their correct positions and that all heaters are alight.
3. Check valves by substitution with ones of the same type known to be good.

4. Check the values of component parts particularly resistors and capacitors for correct value in the correct place.
5. Check for bits of solder or wire ends which may be lodged in the wiring.
6. Check the printed circuit boards for solder 'bridges'.
7. If, after careful visual inspection the trouble is still not located and a voltmeter is available, check the voltage readings against those found in the Voltage Chart.
8. The following control grid 'disturbance' tests will prove helpful in indicating where to look for trouble.

CAUTION: There are high voltages present at various points in the amplifier. **DO NOT TOUCH** these. Be certain you have located the correct test point before proceeding.

() Position the front panel controls as follows:-

Push button Switch	Radio position.
Volume	Position 8 to start, reducing as necessary. Do not adjust this control higher than is necessary to obtain an audible sound in the speaker as serious damage could result to the ECL86 output valves and loudspeakers.
Bass, Treble and Balance Filter	In the mid-position ('12 o'clock').
Channel Reverse Switch	At Linear (fully clockwise).
Mono/Stereo Switch	At 'Normal'. At 'Stereo'.

^B
Channel X. (NOTE: Refer to Pictorial 1 for control tag numbering.)

- () Holding the blade of a small screwdriver touch VC tag 2. A slight hum should be heard from the left-hand speaker.
- () Transfer the screwdriver to TC tag 2. A slight hum increase should be heard from the left-hand speaker.
- () Transfer the screwdriver to FC tag 2. A much louder hum should be heard from the left-hand speaker.

^A
Channel E. (NOTE: Refer to Pictorial 1 for control tag numbering.)

- () Transfer the screwdriver to VC tag 5. A slight hum of the same intensity as Channel A should be heard from the right-hand speaker.
- () Transfer the screwdriver to TC tag 5. A slight increase in hum should be heard from the right-hand speaker.
- () Transfer the screwdriver to FC tag 6. A much louder hum should be heard from the right-hand speaker.

9. SPECIFIC TROUBLES.

Hum: Excessive hum in an amplifier is usually caused by poor heater to cathode insulation in a valve, poor chassis connections or faulty electrolytic smoothing capacitors. Capacitors and valves should be checked by direct substitution or by having them tested.

Distortion: Faulty valves, a leaky coupling capacitor or resistors that have changed value due to overheating during assembly. An ohmmeter will prove helpful in checking for leaky capacitors and resistors that are out of tolerance.

Another common form of distortion is caused by overloading the early stages of the amplifier. To prevent this, all signal inputs should be set so that the amplifier is just fully loaded with the volume control near maximum.

Instability: This can be caused by badly soldered connections of the 15 KΩ resistors and 300 pF capacitors (R34, R134, C20, C120) connected on the power amplifier circuit board.

Transformer Winding Resistances

The following resistance values will prove helpful when a transformer is suspected as being faulty:

Mains Transformer

<u>Primary</u>	<u>Colour</u>	<u>Resistance</u>
100-125v tap	Blue to Black	3 ohms
200-210v tap	Blue to Black	8 ohms
220-230v tap	Blue to Black	9 ohms
240-250v tap	Blue to Black	10 ohms

<u>Secondary</u>	<u>Colour</u>	<u>Resistance</u>
6.3v	Yellow to Yellow	0.1 ohms
6.3v	Green to Green	0.1 ohms
5.0v	Red to Red	0.1 ohms
270v	Red (flexible) to Brown	60 ohms
0v	Brown (flexible)	-
270v	Red (flexible) to Brown (flexible)	60 ohms

Output Transformer

<u>Primary</u>	<u>Colour</u>	<u>Resistance</u>
	Red to Black	20 ohms
	Red to White	20 ohms
	Red to Blue	100 ohms
	Red to Yellow	100 ohms

<u>Secondary</u>	<u>Colour</u>	<u>Resistance</u>
	Green to Yellow	0.1 ohms
	Green to Violet	0.5 ohms

The following tests using an accurate ohmmeter, will prove helpful in locating resistors that are incorrectly positioned or faulty.

For these tests the mains supply must be disconnected and controls set as stated on Page 42.

Resistance readings $\pm 10\%$, measured between stated location and chassis; These are associated with the control grids of each stage.

RESISTANCE CHART

LOCATION	SEE PICTORIAL	RESISTANCE
VC-3 and VC-6	1	140 K
FC-2 and FC-5	1	500 K
TC-2 and TC-5	1	500 K
BC-2 and BC-5	1	270 K
SC-2 and SC-5	1	140 K
BV-7 and TV-7	13, 14	470 K
LA-4 and LB-4	13	90 Ω

VOLTAGE CHART

VALVE		Pin 1	Pin 2	Pin 3	Pin 4	Pin 5	Pin 6	Pin 7	Pin 8	Pin 9
TYPE	REF.									
EF86	V1 & V6	45	N	1.3	6.3*	6.3*	65	N	1.3	N
ECC83	V2 (a & b) & V7 (a & b)	180	N	1.8	6.3*		130	N	1.1	6.3*
ECC83	V3 (a & b)	150	N	1.3	6.3*		150	N	1.3	6.3*
ECL86	V4 (a & b) & V8 (a & b)	N	1.8	305	6.3*	6.3*	305	10	N	180
ECL86	V5 (a & b) & V9 (a & b)	28*	28	305	6.3*	6.3*	305	10	N	250
GZ34	V10	N	5* 320	N	540*	N	540*	N	5* 320	-

* this voltage is not significant

The above voltages were measured with a high impedance voltmeter, 20,000 ohms per volt. Meters with a low input impedance will give lower voltage readings in some places.

DC readings within \pm 15% of those stated may be considered correct.

* Denotes AC voltage between pins. All other voltages are DC, positive with respect to chassis.

N Denotes no significant voltage.

If you are still in difficulty, refer to the section SERVICE INFORMATION.

STEREOPHONIC SOUND

However good a single channel sound system may be, it is inevitable that the reproduction will lack depth and perspective. In other words, the sound still emerges from one source, in effect, a small hole. It is true that a greater spatial distribution can be secured by means of reflectors or by using two spaced speaker systems, but the reproduction will still be unnatural, it cannot possibly convey the exciting sense of movement, the feeling of life and colour of the concert hall, stage or theatre. With two channel or stereophonic sound, the soloist will appear to take up a position in front of the orchestra which seems to fill the entire room space in front of you, strings on the left and brass on the right, just as they are in the concert hall. How this is accomplished is readily seen by a glance at the two diagrams (see Figures 18(a) and 18(b)).

Localisation of the sound source is effected by intensity, time and phase difference according to frequency, and it is generally agreed that the lower frequencies give very little directional information.

Stereophonic sound is not by any means a new invention. As far back as 1931, Blumlein of E.M.I. patented a system for the simultaneous recording of two separate sound tracks on a single disc. At that time, of course, it involved the use of steel needles and 78 r.p.m. records, which imposed severe limitations on the quality of reproduction possible, consequently the idea was not applied commercially. However, the tremendous improvement in recording techniques, culminating in the introduction of the microgroove record by Columbia of America in 1948, coupled with the development of all the high fidelity equipment - amplifiers, speakers and light-weight pick-ups - changed the picture considerably.

Cookin America had evolved a stereo disc with two separate tracks (which of course had the disadvantage of halving the playing time) but the real impetus for the development of stereo discs came in 1955, when E.M.I. introduced stereo tapes and in 1957 both Pye and Decca released stereo records. Arthur Haddy, the Decca Chief Recording Engineer, had in fact been working for 5 years on this problem.

The original system used a carrier method, however, this was abandoned and a 'hill-and-dale' lateral method was adopted. The present system, agreed as an international standard, is basically the same but the groove is in effect rotated 45 degrees, see Figures 16(a) and 16(b).

It is a fallacy to suppose that inferior reproducing equipment will give good stereo results, the stringent requirements necessary for high-fidelity sound always apply. In particular, the loudspeaker systems should be the best the user can possibly afford. Always remember that the finest amplifier in the world will sound indifferent if used with an inferior speaker.

Great care must be taken when choosing suitable speaker systems and, when making listening tests, be sure to choose a wide variety of programme material. Remember that an inferior speaker with a 'peaky' treble response may appear to give very brilliant reproduction of brass instruments but will give poor speech quality and add a 'wiriness' to string tone. Again, under some circumstances a speaker with pronounced cabinet resonances may appear to have fuller bass response than a system having a clean natural bass. The function of a loudspeaker is to reproduce exactly what is put into it without colouring the sound with tonal characteristics of its own.

In general, highly directional systems should not be used as although they are capable of giving excellent stereo results, the effective listening area is very restricted. (See Figure 17.) Loudspeakers should be placed from 8 to 12 feet apart and facing inwards as much as possible. In general, the best results are obtained with the 'focal point' of the two speakers in front of the listening area. The optimum listening position will be at a point equidistant from the two speakers, but the size of the listening area will depend on their sound distribution or polar diagram and the room acoustics. The Heathkit 'Cotswold' speaker systems are specially recommended for those who want the highest possible fidelity.

BIBLIOGRAPHY

For those interested in a more comprehensive study of stereo and high fidelity sound production in general, the following are recommended:-

Periodicals

'Hi-Fi News'
 'The Gramophone'
 'Audio & Record Review'
 'Wireless World'
 'Practical Wireless'
 'Radio Constructor'
 and the American periodicals:
 'High Fidelity'
 'Audio'

Books

'Hi-Fi Year Book'
 'Loudspeakers' by Briggs
 'Sound Reproduction' by Briggs
 'High Fidelity Sound Reproduction' by Malloy
 'The Gramophone Handbook' by P. Wilson
 'High Quality Sound Reproduction' by J. Moir
 'Stereo Handbook' by Briggs

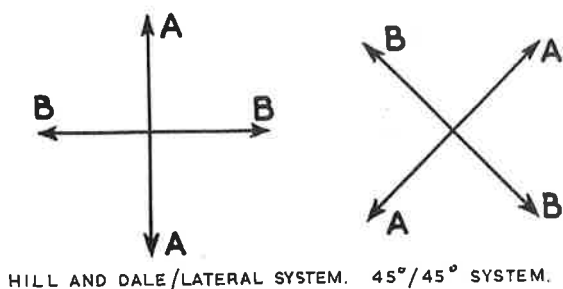

**STEREO PICK-UP AND
 RECORDING MOVEMENTS
 COMPARED.**

FIGURE-16A FIGURE-16B

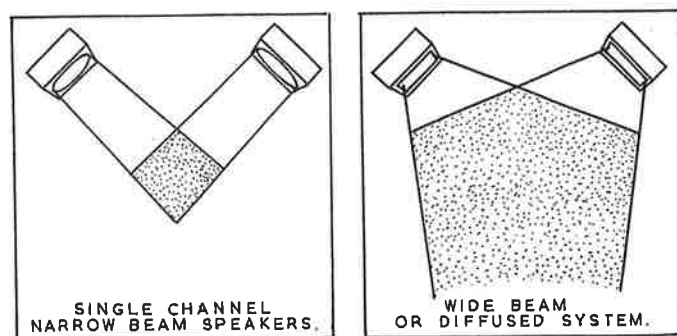

**OPTIMUM STEREO LISTENING AREA SHOWN SHADED.
 RELATIVE SPEAKER AREAS.**

FIGURE-17.

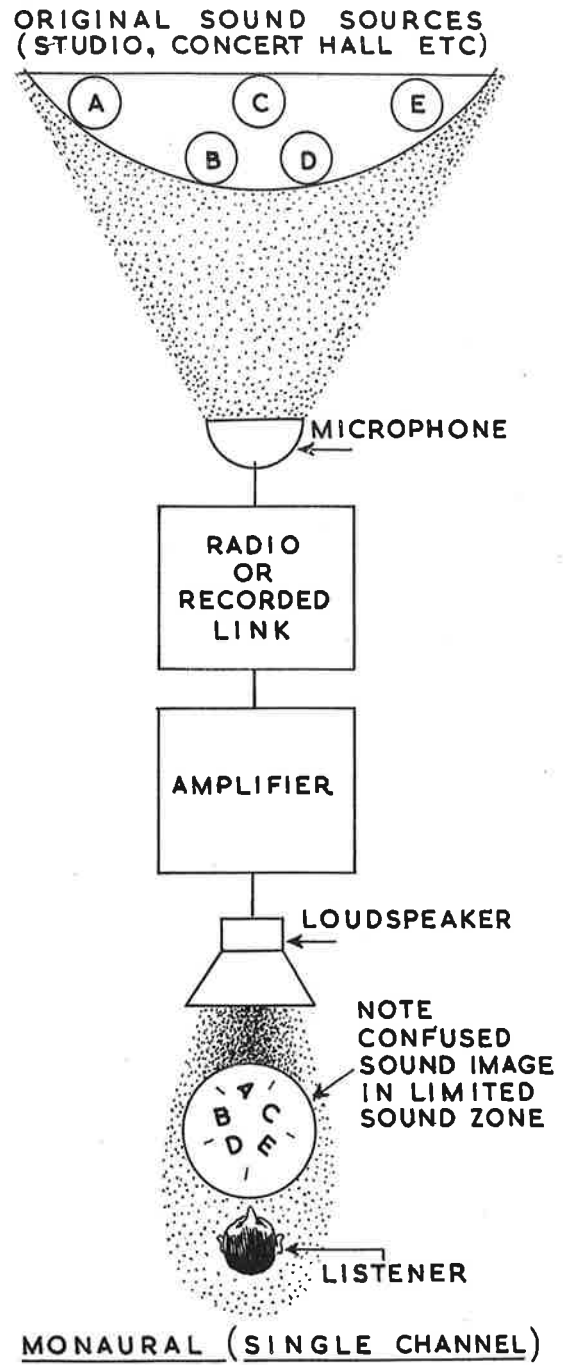
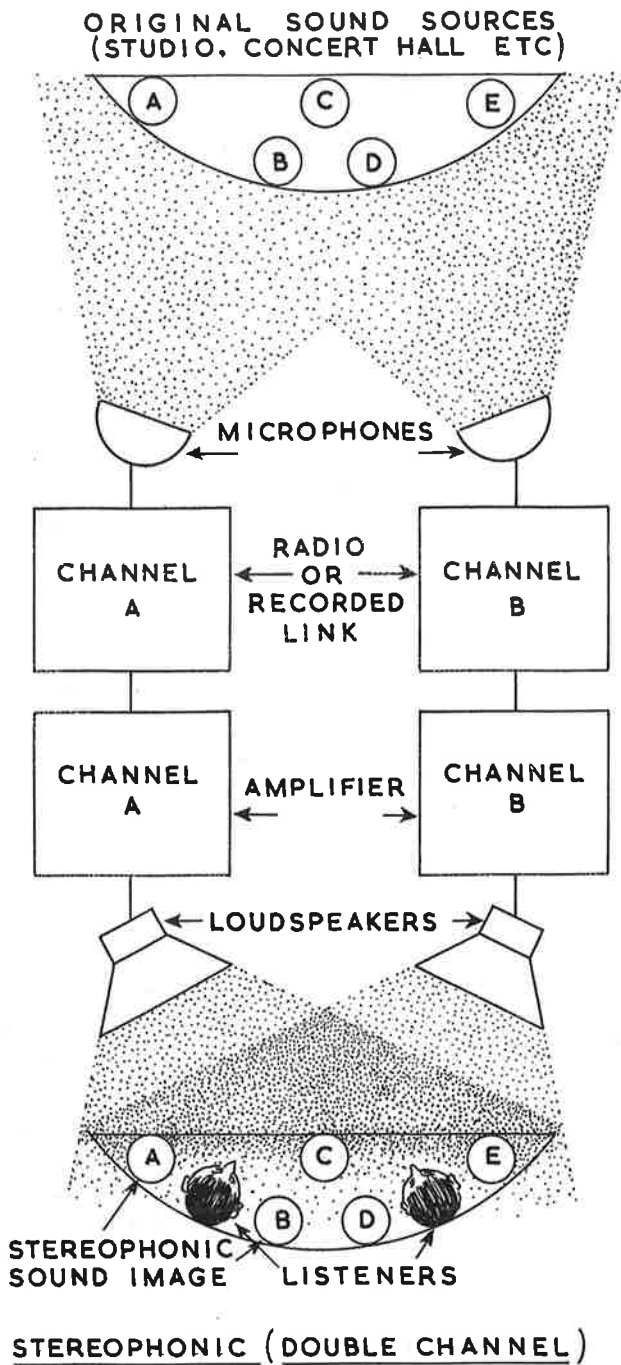

STEREO AND MONAURAL SOUND SYSTEMS COMPARED

NOTE. THE "3D" NATURAL REPRODUCTION OF ORIGINAL SOUND, ENABLING LISTENERS TO DISTINGUISH RELATIVE POSITION OF THE DIFFERENT SOUND SOURCES.

FIG.18A

FIG.18B



SERVICE INFORMATION

SERVICE

If, after applying the information contained in this manual, you are still unable to obtain proper performance, it is suggested that you take advantage of the technical facilities which we make available to our customers.

The Technical Consultation Department is maintained for your benefit. This service is available to you at no charge. Its primary purpose is to provide assistance for those who encounter difficulty in the construction, operation or maintenance of HEATHKIT equipment.

Although the Technical Consultants are familiar with all details of this kit, the effectiveness of their advice will depend entirely upon the amount and the accuracy of the information furnished by you. Please use this outline:

1. Before writing, fully investigate each of the hints and suggestions listed in this manual under In Case of Difficulty. Possibly one of these will solve your problem.
2. When writing, clearly describe the nature of the trouble and mention all associated equipment. Specifically report operating procedures, switch positions, connections to other units and anything else that might help to isolate the cause of trouble.
3. Report fully on the results obtained when testing the unit initially and when following the suggestions under In Case of Difficulty. Be as specific as possible and include voltage readings if test equipment is available.
4. Identify the kit model number, invoice number and date of purchase, if available.
5. Print or type your name and address, preferably at the head of the letter.

With the preceding information, the consultant will know exactly what kit you have, what you would like him to do for you and the difficulty you wish to correct. The date of purchase tells him whether or not engineering changes have been made since it was sent to you. He will know what you have done in an effort to locate the cause of trouble and, thereby, avoid repetitious suggestions. In short, he will devote full time to the problem at hand, and through his familiarity with the kit, plus your accurate report, he will be able to give you a complete and helpful answer. If replacement parts are required, they will be sent to you, subject to the terms of the Guarantee.

HEATHKIT equipment purchased locally and returned to Daystrom Limited for service must be accompanied by your copy of the dated sales receipt from your authorised HEATHKIT dealer in order to be eligible for parts replacement under the terms of the Guarantee.

If the completed instrument should fail to function properly and attempts to find and cure the trouble prove ineffective, the facilities of Daystrom's Service Department are at your disposal. Your instrument may be returned carriage paid to Daystrom Limited, Gloucester, and the Company will advise you of the service charge where not covered within the terms of the Guarantee (i. e. a faulty component supplied by us).

For information regarding modification of HEATHKIT equipment for special applications, it is suggested that you refer to any one or more of the many publications that are available on all phases of electronics. They can be obtained at or through your local library, as well as at most electronic equipment stores. Although Daystrom Ltd. sincerely welcomes all comments and suggestions, it would be impossible to design, test, evaluate and assume responsibility for proposed circuit changes for special purposes. Therefore, such modifications must be made at the discretion of the kit builder, using information available from sources other than Daystrom Limited.

REPLACEMENTS

Material supplied with HEATHKIT products has been carefully selected to meet design requirements and ordinarily will fulfill its function without difficulty. Occasionally improper instrument operation can be traced to a faulty component. Should inspection reveal the necessity for replacement, write to Daystrom Limited and supply all of the following information.

- A. Thoroughly identify the part in question by using the part number and description found in the manual Parts List.
- B. Identify the type and model number of kit in which it is used.
- C. Mention date of purchase.
- D. Describe the nature of defect or reason for requesting replacement.

Daystrom Limited will promptly supply the necessary replacement. PLEASE DO NOT RETURN THE ORIGINAL COMPONENT UNTIL SPECIFICALLY REQUESTED TO DO SO. Do not dismantle the component in question as this will void the guarantee. This replacement policy does not cover the free replacement of parts that may have been broken or damaged through carelessness on the part of the kit builder.

SHIPPING INSTRUCTIONS

Before returning a unit for service, be sure that all parts are securely mounted.

ATTACH A LABEL TO THE INSTRUMENT GIVING
NAME, ADDRESS AND TROUBLE EXPERIENCED.

Pack in a rugged container, preferably wood, using at least three inches of shredded newspaper, wood wool or plastic cushioning material on all sides. DO NOT DESPATCH IN THE ORIGINAL KIT CARTON AS THIS CARTON IS NOT CONSIDERED ADEQUATE FOR SAFE SHIPMENT OF THE COMPLETED INSTRUMENT. Note that a carrier cannot be held liable for damage in transit if packing, in HIS OPINION, is insufficient.

PRICES: All prices are subject to change without notice.

MODIFICATIONS TO SPECIFICATIONS: Daystrom Limited reserves the right to discontinue instruments and to change specifications at any time without incurring any obligation to incorporate new features in instruments previously sold.

* * * * *

The Heathkit builder is again strongly urged to follow step-by-step instructions given in this Manual to ensure successful results. Daystrom Limited assumes no responsibility for any damages or injuries sustained in the assembly or handling of any of the parts of this kit or the completed instrument.

GUARANTEE

Daystrom Limited guarantee subject to the following terms to repair or replace free of charge any defective parts of this Heathkit (with the exception of cathode ray tubes and valves referred to hereunder) which fail owing to faulty workmanship or material provided the defective parts are returned to Daystrom Limited within 12 months from date of purchase:—

1. This guarantee is given to and for the benefit of the original buyer only, and is and shall be in lieu of, and there is hereby expressly excluded, all other guarantees conditions or warranties, whether express or implied, statutory or otherwise, as to quality or fitness for any purpose of the equipment, and in no event shall Daystrom Limited be liable for any loss of anticipated profits, damages, consequential or otherwise, injury, loss of time or other losses whatsoever incurred or sustained by the buyer in connection with the purchase, assembly or operation of Heathkits or components thereof.
2. No replacement will be made of parts damaged by the buyer in the course of handling, assembling, testing or operating Heathkit equipment.
3. The purchaser shall comply with the Replacements Procedure laid down in the relevant Heathkit Manual.
4. Daystrom Limited will not replace, repair or service instruments or parts thereof in which acid core solder or paste fluxes have been used and in such event this guarantee shall be completely void.

Note: The Cathode Ray Tubes and Valves forming part of the equipment are guaranteed by the respective manufacturers. It should be noted that their guarantee is given only in respect of faulty workmanship and/or material and does not cover misuse or consequential damage.

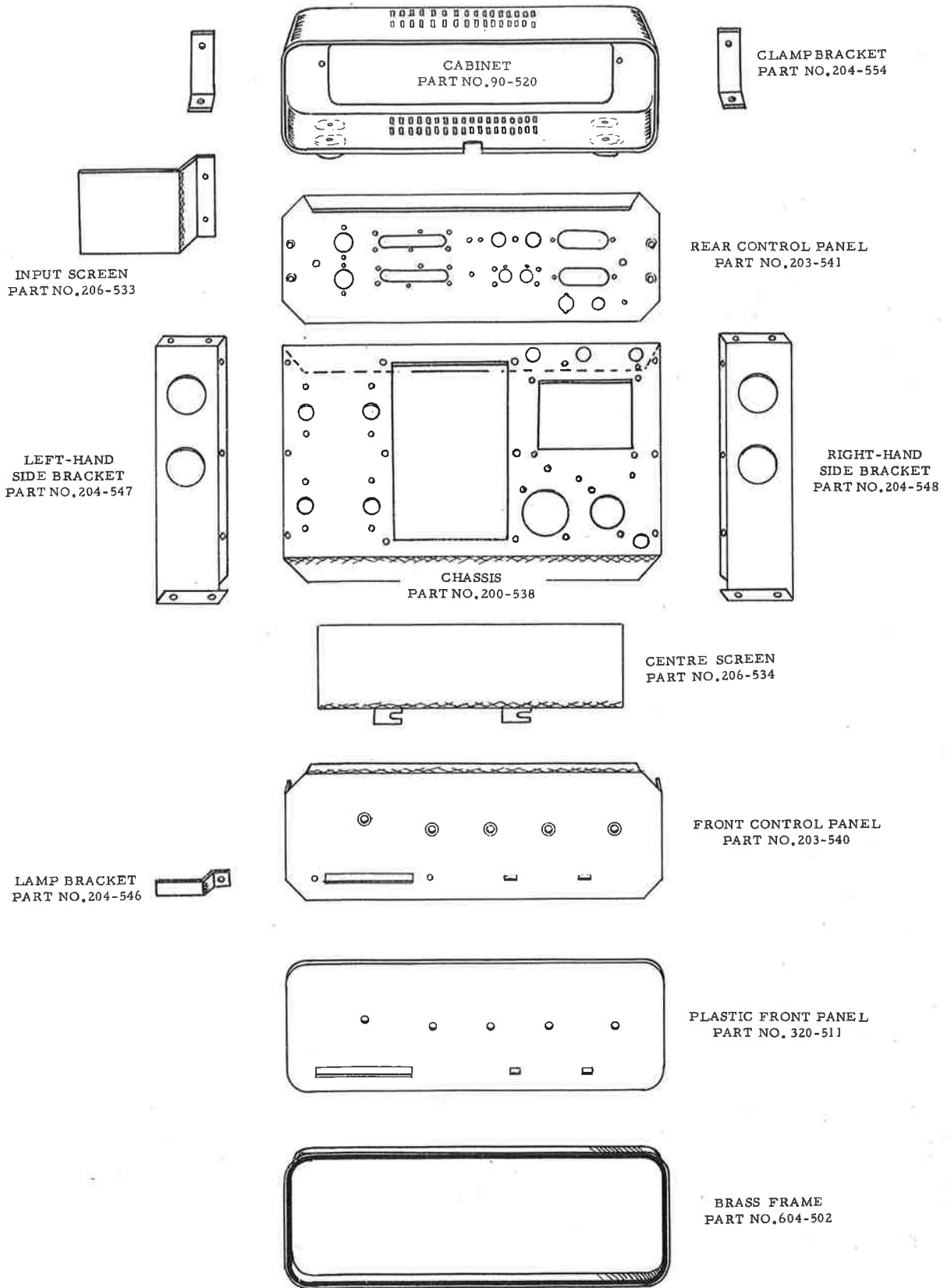

FIGURE-19.

PARTS LIST

PART No.	PARTS Per Kit	DESCRIPTION	PART No.	PARTS Per Kit	DESCRIPTION
Resistors ($\frac{1}{2}$ watt)			Transformers		
H-101C10	2 ✓	100 Ω (Brown, Black, Brown)	54-529	1 ✓	Mains transformer
H-221C10	4 ✓	220 Ω (Red, Red, Brown)	51-507	2 ✓	Output transformer
H-681C5	2 ✓	680 Ω (Blue, Grey, Brown)	Capacitors (all types)		
H-102C10	2 ✓	1 K Ω (Brown, Black, Red)	20-502	2 ✓	300 pF mica 5%
H-222C10	4 ✓	2.2 K Ω (Red, Red, Red)	20-504	4 ✓	1,000 pF mica 5%
H-272C10	2 ✓	2.7 K Ω (Red, Violet, Red)	20-503	2 ✓	680 pF mica 5%
H-472C10	4 ✓	4.7 K Ω (Yellow, Violet, Red)	21-501	2 ✓	47 pF ceramic 5%
H-153C10	2 ✓	15 K Ω (Brown, Green, Orange)	21-502	2 ✓	100 pF ceramic 5%
H-223C10	6 ✓	22 K Ω (Red, Red, Orange)	21-528	8 ✓	300 pF ceramic 10%
H-473C10	6 ✓	47 K Ω (Yellow, Violet, Orange)	21-503	4 ✓	5,000 pF ceramic 10%
H-823C10	2 ✓	82 K Ω (Grey, Red, Orange)	23-3	6 ✓	.01 μ F paper 400v
H-104C10	14 ✓	100 K Ω (Brown, Black, Yellow)	23-501	2 ✓	.05 μ F paper 400v
H-274C10	2 ✓	270 K Ω (Red, Violet, Yellow)	23-502	4 ✓	.1 μ F paper 400v
H-334C10	4 ✓	330 K Ω (Orange, Orange, Yellow)	23-505	2 ✓	.1 μ F paper 250v
H-474C10	202/20 ✓	470 K Ω (Yellow, Violet, Yellow)	23-511	6 ✓	.02 μ F paper 400v
H-564C10	2 ✓	560 K Ω (Green, Blue, Yellow)	25-533	2 ✓	16 μ F electrolytic 275v
H-105C10	4/4 ✓	1 megohm (Brown, Black, Green)	25-501	14 ✓	25 μ F electrolytic 25v
H-225C10	4 ✓	2.2 megohm (Red, Red, Green)	25-535	1 ✓	60-75 μ F electrolytic 450v
H-106C10	2 ✓	10 megohm (Brown, Black, Blue)	Valveholders, Sockets, Plugs, Tagstrips		
Resistors (1 watt)			434-503	1 ✓	Octal valveholder
1-271C10	4 ✓	270 Ω (Red, Violet, Brown)	434-528	9 ✓	B9A valveholder, printed circuit
1-682C10	1 ✓	6.8 K Ω (Blue, Grey, Red)	434-529	2 ✓	5-way phono socket
1-103C10	1 ✓	10 K Ω (Brown, Black, Orange)	434-505	1 ✓	2-way phono socket
Resistors (High Stability)			438-501	8 ✓	Phono plug
Q-472HS5	2 ✓	4.7 K Ω $\frac{1}{4}$ watt (value marked)	431-502	1 ✓	4-way tagstrip, single fixing
H-473HS5	4 ✓	47 K Ω $\frac{1}{2}$ watt (value marked)	431-523	2 ✓	4-way tagstrip, double fixing
Q-224HS5	3 ✓	220 K Ω $\frac{1}{4}$ watt (value marked)	431-524	3 ✓	6-way tagstrip, double fixing
Q-155HS5	2 ✓	1.5 megohm $\frac{1}{4}$ watt (value marked)	431-525	1 ✓	2-way tagstrip, double fixing
Controls (potentiometers)			431-1U	2 ✓	1-way tagstrip, single fixing
11-509	2 ✓	100 Ω potentiometer, single with screwdriver slot	431-505	2 ✓	3-way terminal strip
10-541	1 ✓	500 K Ω lin. potentiometer, dual with centre tap	Hardware (screws, nuts, washers, etc.)		
10-542	1 ✓	500 K Ω lin. potentiometer, dual	250-501	30 ✓	6BA x $\frac{1}{4}$ " binderhead screw
10-538	1 ✓	500 K Ω reverse log potentiometer, dual	250-504	8 ✓	6BA x 5/16" c'sk head screw
19-516	1 ✓	500 K Ω log potentiometer, dual with mains switch	250-513	55 ✓	4BA x $\frac{1}{4}$ " binderhead screw
10-530	2 ✓	1 megohm potentiometer, single with knob	250-542	4 ✓	4BA x $\frac{3}{4}$ " binderhead screw
10-540	1 ✓	1 megohm lin. potentiometer, dual	250-512	4 ✓	2BA x $\frac{1}{2}$ " binderhead screw
Controls (switches)			252-522	4 ✓	6BA speednut
60-501	1 ✓	Slide switch, S.P. ON/OFF (2-tag)	252-501	26 ✓	6BA full nut
60-502	1 ✓	Slide switch, D.P.C.O. (6-tag)	252-3U	34 ✓	4BA full nut
64-505	1 ✓	Press button switch (4)	252-514	4 ✓	2BA half nut
Valves, Lamps			252-519	7 ✓	3/8" control nut
411-501	2 ✓	EF86	254-501	22 ✓	6BA lockwasher
411-507	3 ✓	ECC83 (12AX7)	254-1U	45 ✓	4BA lockwasher
411-532	4 ✓	ECL86	254-503	7 ✓	3/8" lockwasher
411-504	1 ✓	GZ34	253-501	7 ✓	3/8" flat washer
412-4	1 ✓	6.3v lamp, M. E. S.	253-504	8 ✓	2BA lockwasher
			250-533	4 ✓	2BA flat washer
			6BA x $\frac{3}{16}$ " CHEESEHEAD SCREWS.		
			Wire, Solder		
			344-500	1 length ✓	Black insulated
			344-501	1 length ✓	Brown insulated
			344-502	1 length ✓	Red insulated
			344-503	1 length ✓	Orange insulated
			344-504	1 length ✓	Yellow insulated

PARTS LIST (cont'd.)

PART No.	PARTS Per Kit	DESCRIPTION	PART No.	PARTS Per Kit	DESCRIPTION
Wire, Solder (cont'd.)			Sheet Metal Parts (cont'd.)		
344-505	1 length ✓	Green insulated	604-502	1 ✓	Brass frame
344-506	1 length ✓	Blue insulated	204-554	2 ✓	Clamp bracket
344-507	1 length ✓	Violet insulated	Miscellaneous		
344-508	1 length ✓	Grey insulated	434-520	1 ✓	Lampholder M. E. S.
344-509	1 length ✓	White insulated	73-501	9 ✓	3/8" grommet
344-521	1 length ✓	Pink insulated	255-506	2 ✓	3/8" x 5/32" bore spacer
343-503	1 length ✓	Single core screened cable	255-512	6 ✓	5/8" x 4BA pillar
343-504	1 length ✓	3-core screened cable	255-513	4 ✓	3" x 4BA pillar
89-502	1 length ✓	3-core mains cable	320-501	1 length ✓	Foam plastic strip
346-1	1 length ✓	1 1/2 m. m. sleeving	259-504	5 ✓	4BA shakeproof solder tag
346-502	1 length ✓	2 1/2 m. m. sleeving	423-501	1 ✓	Fuseholder (panel mounting)
340-501	1 length ✓	Tinned copper wire 22 swg. THIN	423-504	1 ✓	Fuseholder (chassis mounting)
340-503	1 length ✓	Tinned copper wire 18 swg. THICK	421-506	2 ✓	Fuse link 2.5 amp (one spare)
331-501	1 length ✓	60/40 solder 18 swg. (thick)	421-507	2 ✓	Fuse link 500 mA (one spare)
331-502	1 length ✓	60/40 solder 22 swg. (thin)	261-504	4 ✓	Rubber feet
Sheet Metal Parts			462-501	4 ✓	Knob
90-520	1 ✓	Cabinet	462-502	1 ✓	Knob, small pointer
200-538	1 ✓	Chassis	85-523	1 ✓	Circuit board (power amp)
203-540	1 ✓	Front control panel	85-524	1 ✓	Circuit board (pre-amp)
203-541	1 ✓	Rear control panel	85-509	2 ✓	Circuit board (gram. comp.)
204-547	1 ✓	Left-hand side bracket	320-511	1 ✓	Plastic front panel
204-548	1 ✓	Right-hand side bracket	448-507	1 length ✓	Adhesive tape on dowel
206-534	1 ✓	Centre screen	481-503	1 ✓	Capacitor mounting plate
206-533	1 ✓	Input screen	630-501	1 ✓	Nut starter (6BA and 4BA)
204-546	1 ✓	Lamp bracket	595-547	1 ✓	Instruction Manual

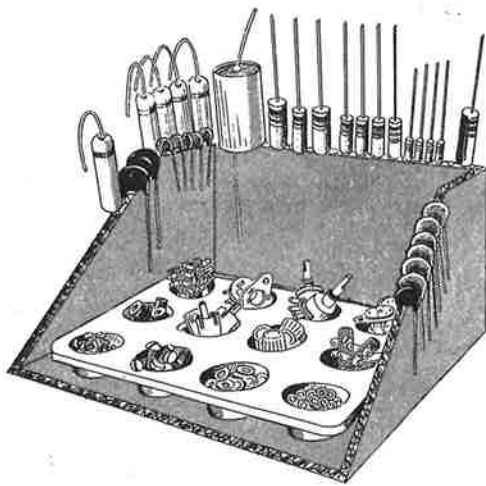

Note on Part 343-3
Screened wire. Please note
that lapped screened wire
is supplied in lieu of
branded screened wire. It
will not therefore be
required to withdraw the
inner wire as shown
in the manual.

This illustration shows how resistors and capacitors may be placed in the cut edge of a corrugated cardboard carton until they are needed. Their values can be written on the cardboard next to each component.

HELPFUL KIT BUILDING INFORMATION

Before attempting actual kit construction read the construction manual thoroughly to familiarise yourself with the general procedure. Note the relative location of pictorial inserts in respect of the progress of the assembly procedure outlined. This information is offered primarily for the convenience of the novice kit builders and will be of definite assistance to those lacking thorough knowledge of good construction practices. Even the advanced electronic enthusiast may benefit by a brief review of this material before proceeding with kit construction. In the majority of cases, failure to observe basic instruction fundamentals is responsible for inability to obtain desired level of performance.

RECOMMENDED TOOLS

The successful construction of Heathkits does not require the use of specialised equipment and only basic tools are required. A good quality electric soldering iron is essential. The preferred size would be a 25-50 watt iron with a small tip. The use of long nose pliers and a diagonal or side cutting pliers is recommended. A small screw driver will prove adequate and several additional assorted screw drivers will be helpful. Be sure to obtain a good supply of resin core type radio solder. Never use separate fluxes, paste or acid solder in electronic work.

ASSEMBLY

In the actual mechanical assembly of components to the chassis and panel, it is important that the procedure shown in the manual be carefully followed. Make sure that the valve holders are properly mounted in respect to keyway or pin numbering location. The same applies to transformer mountings so that the correct transformer colour coded wires will be available at the proper chassis opening. Make it a standard practice to use lockwashers under all 4BA and 2BA nuts. The only exception being in the use of soldering tags - the necessary locking feature is already incorporated in the design of the soldering tags. A control lock washer should always be used between the control and the chassis to prevent undesirable rotation in the panel. To improve instrument appearance and to prevent possible panel marring use a control flat nickel washer under each control nut.

When installing terminals that require the use of fibre insulating washers, it is good practice to slip the shouldered washer over the terminal stud before installing the mounting stud in the panel hole provided. Next, install a flat fibre washer and a soldering tag under the mounting nut. Be sure that the shouldered washer is properly centred in the panel to prevent possible shorting of the terminal.

WIRING

When following the wiring procedure make the leads as short and direct as possible. In filament wiring requiring the use of a twisted pair of wires allow sufficient slack in the wiring that will permit the twisted pair to be pushed against the chassis as closely as possible thereby affording relative isolation from adjacent parts and wiring.

When removing insulation from the end of connecting wire, it is seldom necessary to expose more than a quarter inch of the wire. Excessive insulation removal may cause a short circuit condition in respect of nearby wiring or terminals. In some instances, transformer leads of solid copper will have a brown baked enamel coating. After the transformer leads have been trimmed to a suitable length, it is necessary to scrape the enamel coating in order to expose the bright copper wire before making a terminal or soldered connection.

In mounting parts such as resistors or capacitors, trim off all excess lead lengths so that the parts may be installed in a direct point-to-point manner. When necessary use insulated sleeving over exposed wires that might short to nearby wiring. It is urgently recommended that the wiring and parts layout as shown in the construction manual be faithfully followed. In every instance the desirability of this arrangement was carefully determined following the construction of a series of laboratory models.

SOLDERING

Much of the performance of the kit instrument, particularly in respect of accuracy and stability, depend upon the degree of workmanship used in making soldered connections. Properly soldered connections are not at all difficult to make but it would be advisable to observe a few precautions. First of all before a connection is to be soldered, the connection itself should be clean and mechanically strong. Do not depend on solder alone to hold a connection together. The tip of the soldering iron should be bright, clean and free of excess solder. Use enough heat so that the solder flows thoroughly and smoothly into the joint. Avoid excessive use of solder and do not allow a flux flooding condition to occur which could conceivably cause a leakage path between adjacent terminals on switch assemblies and valve holders. This is particularly important in instruments such as the VVM, oscilloscope and generator kits. Excessive heat will also burn or damage the insulating material used in the manufacture of switch assemblies. Be sure to use only good quality resin core type solder.

AERIAL		CAPACITOR (VARIABLE)		SWITCH — SINGLE POLE (S.P.) SINGLE THROW (S.T.)		BATTERY	
LOOP		RESISTOR		SWITCH — DOUBLE POLE (D.P.) DOUBLE THROW (D.T.)		FUSE	
DIPOLE		RESISTOR (TAPPED)		SWITCH — TRIPLE POLE (T.P.) DOUBLE THROW (D.T.)		CRYSTAL	
EARTH		RESISTOR (VARIABLE)		LOUDSPEAKER		TERMINAL & TERMINAL STRIP	
INDUCTOR (COIL OR R.F. CHOKE)		POTENTIOMETER		RECTIFIER		WIRING BETWEEN LIKE LETTERS IS UNDERSTOOD	
R.F. COIL WITH ADJUSTABLE IRON DUST CORE		JACK (TWO CONDUCTOR)		MICROPHONE		MICRO (x 1/1,000,000) = μ	
L.F. CHOKE (IRON CORED) WITH TAPPINGS		JACK (THREE CONDUCTOR)		TYPICAL TUBE SYMBOL		MILLI (x 1/1000) = m	
R.F. TRANSFORMER (AIR CORE)		WIRES CONNECTED		TRANSISTOR (P.N.P. TYPE)		KILO (x 1000) = K	
TRANSFORMER (R.F. OR L.F.) ADJUSTABLE IRON DUST CORE		WIRES CROSSING BUT NOT CONNECTED		TRANSISTOR (N.P.N. TYPE)		MEGA (x 1,000,000) = M	
TRANSFORMER (MAINS OR L.F.) IRON CORE		A-AMMETER V-VOLTMETER mA-MILLIAMMETER μA-MICROAMMETER ETC.		SOCKET OUTLET CO AXIAL		OMEGA (OHMS) = Ω	
CAPACITOR		NEON LAMP STABILISER VALVE		TWO PIN SOCKET AND TWO PIN PLUG		MICROFARAD = μF	
CAPACITOR (ELECTROLYTIC)		LAMP PILOT OR ILLUMINATING				PICOFARAD = pF MICRO, MICRO FARAD = μμF	

DAYSTROM LIMITED

A Member of the Daystrom Group

THE WORLDS LARGEST MANUFACTURERS
OF ELECTRONIC KITS

GLOUCESTER, ENGLAND