

PRICE \$1.00



Assembling
and Using Your...

Heathkit

"WILLIAMSON
TYPE"
AMPLIFIER

MODEL W-3AM

HEATH COMPANY

A Subsidiary of Daystrom Inc.

BENTON HARBOR, MICHIGAN

STANDARD COLOR CODE — RESISTORS AND CAPACITORS

AXIAL LEAD RESISTOR

INSULATED UNINSULATED Color	FIRST RING BODY COLOR First Figure	SECOND RING END COLOR Second Figure	THIRD RING DOT COLOR Multiplier
BLACK	0	0	None
BROWN	1	1	0
RED	2	2	00
ORANGE	3	3	,000
YELLOW	4	4	0,000
GREEN	5	5	00,000
BLUE	6	6	000,000
VIOLET	7	7	0,000,000
GRAY	8	8	00,000,000
WHITE	9	9	000,000,000

DISC CERAMIC RMA CODE

RADIAL LEAD DOT RESISTOR

5-DOT RADIAL LEAD CERAMIC CAPACITOR

EXTENDED RANGE TC CERAMIC HICAP

RADIAL LEAD (BAND) RESISTOR

BY-PASS COUPLING CERAMIC CAPACITOR

AXIAL LEAD CERAMIC CAPACITOR

The standard color code provides all necessary information required to properly identify color coded resistors and capacitors. Refer to the color code for numerical values and the zeroes or multipliers assigned to the colors used. A fourth color band on resistors determines tolerance rating as follows: Gold = 5%, silver = 10%. Absence of the fourth band indicates a 20% tolerance rating.

The physical size of carbon resistors is determined by their wattage rating. Carbon resistors most commonly used in Heathkits are 1/2 watt. Higher wattage rated resistors when specified are progressively larger in physical size. Small wire wound resistors 1/2 watt, 1 or 2 watt may be color coded but the first band will be double width.

MOLDED MICA TYPE CAPACITORS

CURRENT STANDARD CODE

JAN & 1948 RMA CODE

RMA 3-DOT (OBSOLETE)

RATED 500 W.V.D.C. ± 20% TOL.

BUTTON SILVER MICA CAPACITOR

RMA (5-DOT OBSOLETE CODE)

RMA 6-DOT (OBSOLETE)

RMA 4-DOT (OBSOLETE)

MOLDED PAPER TYPE CAPACITORS

TUBULAR CAPACITOR

Normally stamped for value

A 2 digit voltage rating indicates more than 900 V. Add 2 zeros to end of 2 digit number.

MOLDED FLAT CAPACITOR

Commercial Code

JAN. CODE CAPACITOR

The tolerance rating of capacitors is determined by the color code. For example: red = 2%, green = 5%, etc. The voltage rating of capacitors is obtained by multiplying the color value by 100. For example: orange = 3 × 100 or 300 volts. Blue = 6 × 100 or 600 volts.

In the design of Heathkits, the temperature coefficient of ceramic or mica capacitors is not generally a critical factor and therefore Heathkit manuals avoid reference to temperature coefficient specifications.

ASSEMBLY AND OPERATION OF THE HEATHKIT "WILLIAMSON TYPE" AMPLIFIER MODEL W-3AM

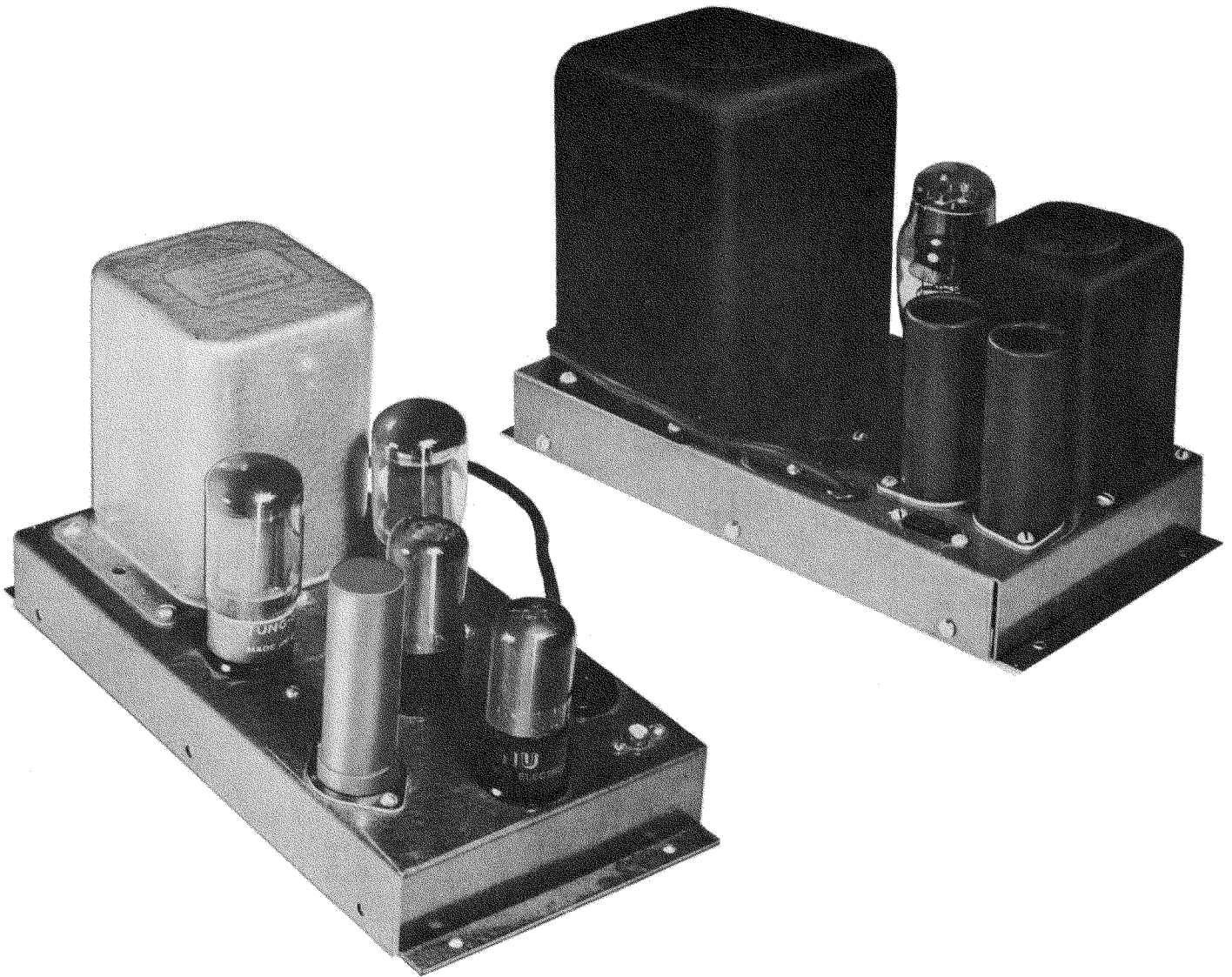

TECHNICAL SPECIFICATIONS

Tube Complement.....	two 6SN7GT, two 5881, one 5V4G.
Output Impedances.....	4, 8, and 16 ohms.
Hum and Noise.....	85.3 db below 20 watt output.
Phase Shift.....	30° leading at 16 cycles, 30° lagging at 20 KC; 90° leading at 5 cycles, 90° lagging at 98.5 KC.
Rated Output.....	20 watts.
Peak Output.....	36 watts.
Feedback Factor.....	Fixed; 18 db, independent of output impedance.
Damping Factor.....	Fixed; 14, independent of output impedance.

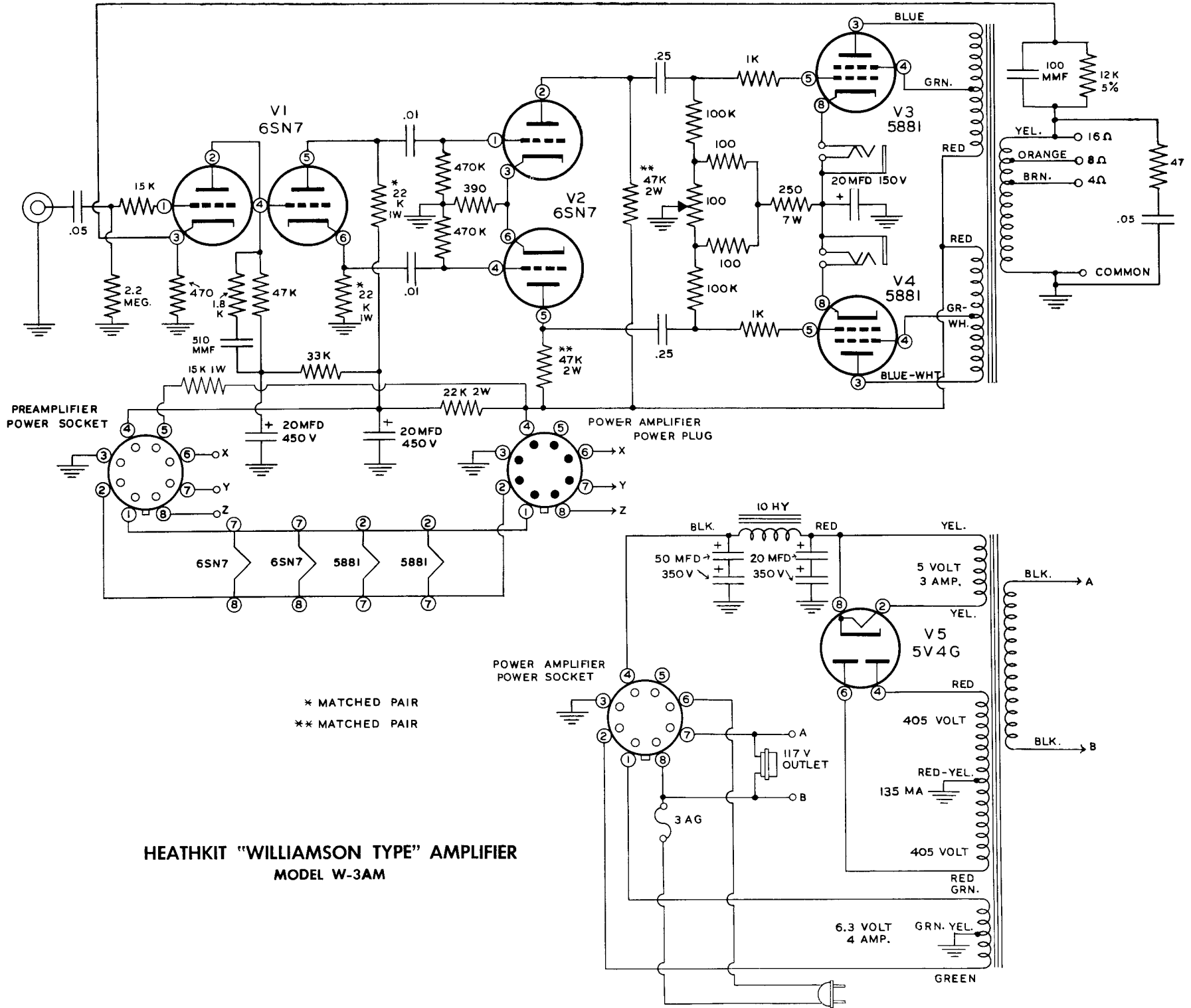

Sensitivity..... Refer to curve.

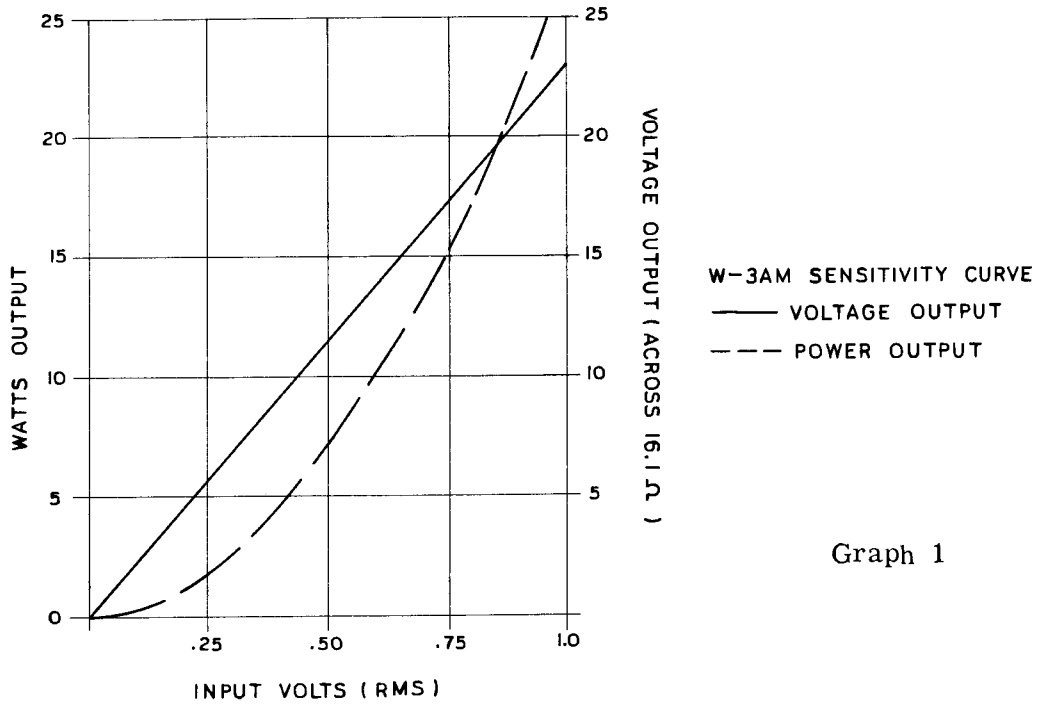

Graph 1

Frequency Response..... ± 1.5 db from 20 cycles to 80 KC at 1 watt output. ± .5 db from 20 cycles to 20 KC at rated output. Refer to curves below for response at power levels.

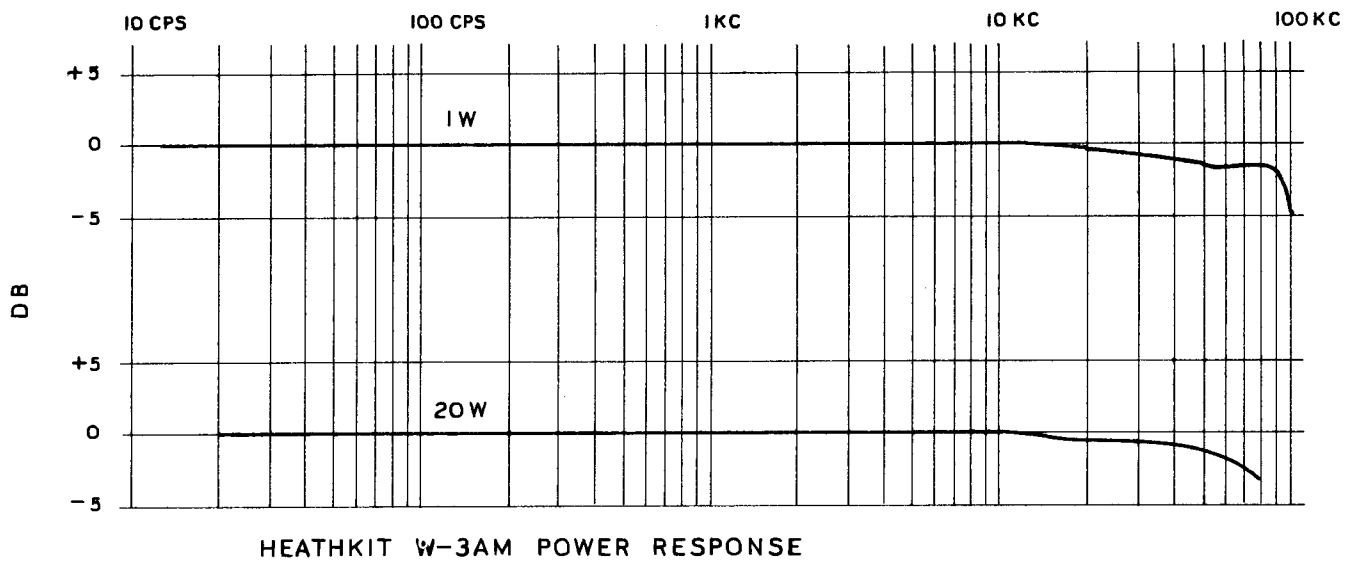

Graph 2

Harmonic Distortion..... The curve below indicates the distortion versus frequency curves for several power levels. From these curves it becomes evident that specifying total harmonic distortion at any power level without designating the test frequency can be very misleading.

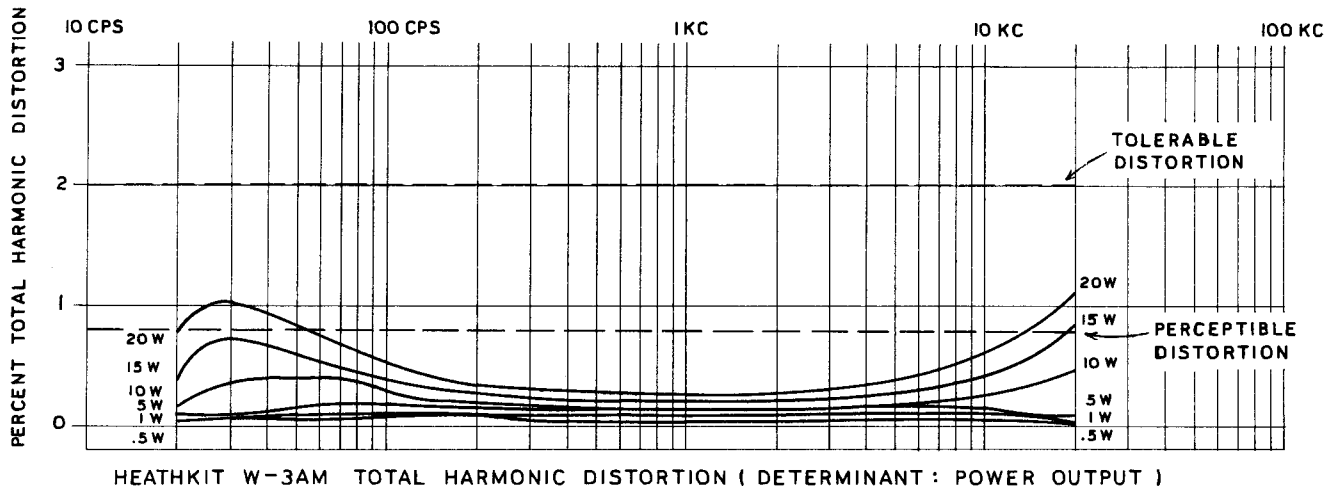

Graph 3

Competent authorities seem to agree that a total of 2% harmonic distortion is tolerable for musical reproduction through wide-range audio equipment. Harmonic distortion below 0.7% is completely imperceptible, even to highly trained critical observers.

Intermodulation Distortion..... Please observe that the generally accepted limit for "high fidelity amplifiers" has been added to the graph. The W-3AM amplifier will supply 20 watts of audio power before the distortion exceeds the "high fidelity" requirements.

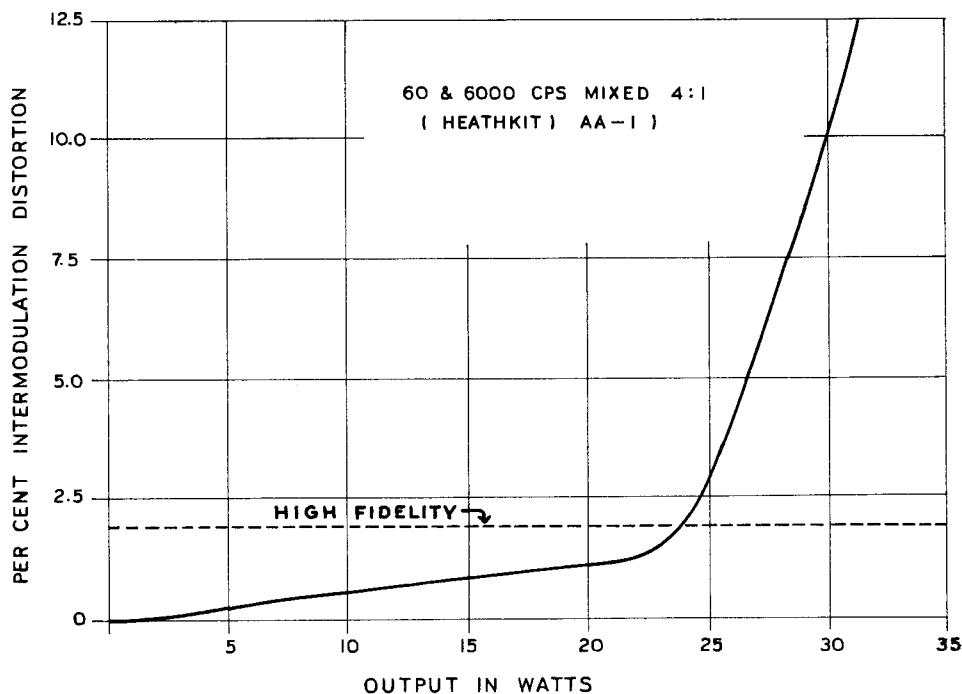

Graph 4

Power Requirements.....105 - 125 volts, 50/60 cycles, 120 watts.
Overall Dimensions (each unit)..... 7" high x 5 1/2" wide x 11" long.
Shipping Weight..... 29 pounds.

TEST CONDITIONS

Measurements taken with line voltage maintained constant at 117 volts. Output impedance 16.1 Ω resistive. For harmonic distortion measurements: Heathkit model HD-1 Harmonic Distortion Analyzer, and Hewlett-Packard model 650-A Test Oscillator. For intermodulation distortion measurements: Heathkit model AA-1 Audio Analyzer. For frequency response measurements: H. P. 650-A Test Oscillator. For phase shift measurements: Krohnkite model 440-A Oscillator (inherent distortion less than .1%) and RCA model WO-56A Oscilloscope. For power output, voltage measurements across 16.1 Ω resistive load taken with Hewlett-Packard model 400-D Vacuum Tube Voltmeter.

Measurements given are those taken on a representative amplifier under the stated conditions. Minor variations may be encountered in kit-assembled amplifiers because of tube characteristics, component variations and exact lead placement. In a highly stabilized amplifier such as the W-3AM, these variables may be disregarded from a performance point of view.

INTRODUCTION

The art and science of the reproduction of sound has steadily made advances with improvements of major importance occurring occasionally. Among these major advances, we count the LP type recordings, the modern magnetic phono pickups, FM broadcasting and the Williamson amplifier circuit.

These advances in different links in the chain of devices needed for reproduction of sound were made when each link appeared to become the weakest one.

In the summer of 1947, Mr. D. T. N. Williamson had the results of his search for a perfect amplifier published in the British periodical "Wireless World." Further notes on this amplifier appeared in the same publication in 1949.

The comparative simplicity of the circuit tempted many skilled home constructors and the remarkable results soon became well known the world over. Several articles appeared in American publications, referring specifically to the original Williamson circuit. The article in the November, 1949 issue of Audio Engineering described a "Musician's Amplifier" patterned after the Williamson.

Not all attempts to duplicate the original performance with other components and different layouts were successful. Thus there developed a thriving trade of importing the components used in the original design, largely to replace parts in existing amplifiers that were lacking in performance.

The Heathkit amplifier closely follows the very successful Musician's Amplifier and is considered by many to surpass the original Williamson.

The original article by Mr. Williamson outlined the six basic requirements for a perfect amplifier as follows: (1) Negligible non-linear distortion. (2) Linear frequency response and power handling capacity over the range of 10 cycles to 20 kc. (3) Negligible phase shift over the same range. (4) Good transient response. (5) Low output resistance. (6) Adequate power reserve.

All six requirements are properly fulfilled in the Heathkit amplifier through the careful choice of component parts and selection of optimum operating conditions.

The operational qualities were of primary concern and thus electrical efficiency has been sacrificed wherever needed. The first requirement of Mr. Williamson calls for the use of only the most linear portion of the tube characteristics. Although that portion has been extended by higher than normal plate supply voltages, it is only a fraction of the curve normally used in amplifiers.

Thus a comparatively low output power level is obtained with tubes capable of much more efficient operation under less stringent requirements.

A recent modification of this circuit has been described by David Sarser and Melvin C. Sprinkle in Audio Engineering for July, 1952. This article, entitled "Gilding the Lily," points out several changes which increase the efficiency of the circuit without perceptible degradation of its performance. The instructions in this manual incorporate these changes. However, instructions are given on Page 19 for building the amplifier in accordance with the original design.

Either circuit, at levels up to 5 watts output, affords performance far beyond the finest speaker systems available today. Average power output for home listening rarely exceeds 1 watt. The circuit as described in the assembly instructions will provide a power output of 12 to 15 watts before intermodulation distortion becomes noticeable, even to the trained ear. The circuit described on Page 19, as originally used by Williamson, displays similar characteristics at levels of 8 to 10 watts.

While the frequency limits of this amplifier are quite outside the audible range of single frequencies, the results are definitely noticeable. The extended range insures exact reproduction of the transients generated at the start of each note, such as the sharp crash of the cymbal, the brief scratching of the bow as it starts to move across the strings of the violin or the deep thud of the kettle drum. The individual instruments of the orchestra are thus quite readily distinguished.

Mr. Williamson's second requirement of both linear frequency response and power handling capability and the third requirement of negligible phase shift call for an output transformer with quite extraordinary characteristics. An incorrectly designed transformer may produce distortion that is easily mistaken for faulty operating conditions of the tubes. The transformer used in the Heathkit amplifier has the characteristics required and may well be considered the heart of the amplifier.

Considering your substantial investment in this kit, it is readily understood that it warrants the greatest care in assembly to reap the performance of which this amplifier is capable.

The model W-3AM is free running with no controls. It is designed to be used with a signal source having its own controls or with a preamplifier. The Heathkit model WA-P2 Preamplifier is highly recommended.

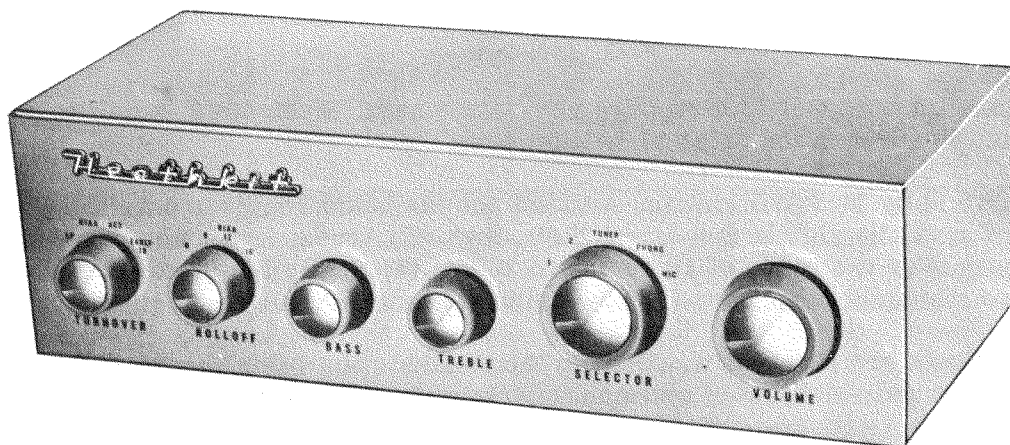

HEATHKIT PREAMPLIFIER MODEL WA-P2

ASSEMBLY AND OPERATION INSTRUCTIONS

This Heathkit amplifier was developed to provide an excellent link in the chain of devices that are required for the highest quality reproduction of sound in the home. To obtain maximum enjoyment from such a chain, the other links (record, stylus, pickup, turntable, speaker and enclosure) should also be of the highest quality.

To realize the full capabilities of this amplifier, the construction should be carried out with the utmost care. Hurried and careless construction may readily lead to difficulties, either initially or after some period of satisfactory operation. Therefore, take the time to do a good job.

This manual has been prepared to help you construct the amplifier with the least possible chance of error. Please read it all the way through before starting any of the work.

UNPACK THE KIT CAREFULLY AND CHECK EACH PART AGAINST THE PARTS LIST. In so doing, you will become acquainted with the parts. Refer to the charts on the inside covers of the manual to help identify any doubtful components. If you find a part missing and you are certain it has not been discarded with the packing material, attach the inspection slip to your claim and notify us promptly of the shortage. Hardware items are counted by weight and if a few are missing, please secure them locally if at all possible.

In order to expedite delivery to you, we are occasionally forced to make minor substitutions of parts. Such substitutions are carefully checked before they are approved and the parts supplied will work satisfactorily. By checking the parts list for resistors, for example, you may find that a 51 K Ω resistor has been supplied in place of a 47 K Ω as shown in the parts list. These changes are self-evident and are mentioned here only to prevent confusion to you in checking the contents of your kit.

Resistors and controls generally have a tolerance rating of $\pm 20\%$ unless otherwise stated in the parts list. Therefore a 100 K Ω resistor may test anywhere between 80 K Ω and 120 K Ω . (The letter K is commonly used to designate a multiplier of 1000.) Tolerances on condensers are generally even greater. Limits of +100% and -50% are common for electrolytic condensers. The parts furnished with your Heathkit have been specified so as to not adversely affect the operation of the finished instrument.

PROPER SOLDERING PROCEDURE

Only a small percentage of Heathkit purchasers find it necessary to return an instrument for factory service. Of these, by far the largest proportion function improperly due to poor or improper soldering.

Correct soldering technique is extremely important. Good solder joints are essential if the performance engineered into the kit is to be fully realized. If you are a beginner with no experience in soldering, a half-hour's practice with odd lengths of wire and a tube socket will be a worthwhile investment.

High quality solder of the proper grade is most important. There are several different brands of solder on the market, each clearly marked "Rosin Core Radio Solder." Such solders consist of an alloy of tin and lead, usually in the proportion of 50:50. Minor variations exist in the mixture such as 40:60, 45:55, etc. with the first figure indicating the tin content. Radio solders are formed with one or more tubular holes through the center. These holes are filled with a rosin compound which acts as a flux or cleaning agent during the soldering operation.

NO SEPARATE FLUX OR PASTE OF ANY KIND SHOULD BE USED. We specifically caution against the use of so-called "non-corrosive" pastes. Such compounds, although not corrosive at room temperatures, will form residues when heated. The residue is deposited on surrounding surfaces and attracts moisture. The resulting compound is not only corrosive but actually destroys the insulation value of non-conductors. Dust and dirt will tend to accumulate on these "bridges" and eventually will create erratic or degraded performance of the instrument.

NOTE: ALL GUARANTEES ARE VOIDED AND WE WILL NOT REPAIR OR SERVICE INSTRUMENTS IN WHICH ACID CORE SOLDER OR PASTE FLUXES HAVE BEEN USED. WHEN IN DOUBT ABOUT SOLDER, IT IS RECOMMENDED THAT A NEW ROLL PLAINLY MARKED "ROSIN CORE RADIO SOLDER" BE PURCHASED.

If terminals are bright and clean and wires free of wax, frayed insulation and other foreign substances, no difficulty will be experienced in soldering. Crimp or otherwise secure the wire (or wires) to the terminal, so a good joint is made without relying on solder for physical strength. To make a good solder joint, the clean tip of the soldering iron should be placed against the joint to be soldered so that the terminal is heated sufficiently to melt solder. The solder is then placed against both the terminal and the tip of the iron and will immediately flow out over the joint. Refer to the sketch below. Use only enough solder to cover wires at the junction; it is not necessary to fill the entire hole in the terminal with solder. Excess solder may flow into tube socket contacts, ruining the socket, or it may creep into switch contacts and destroy their spring action. Position the work so that gravity tends to keep the solder where you want it.

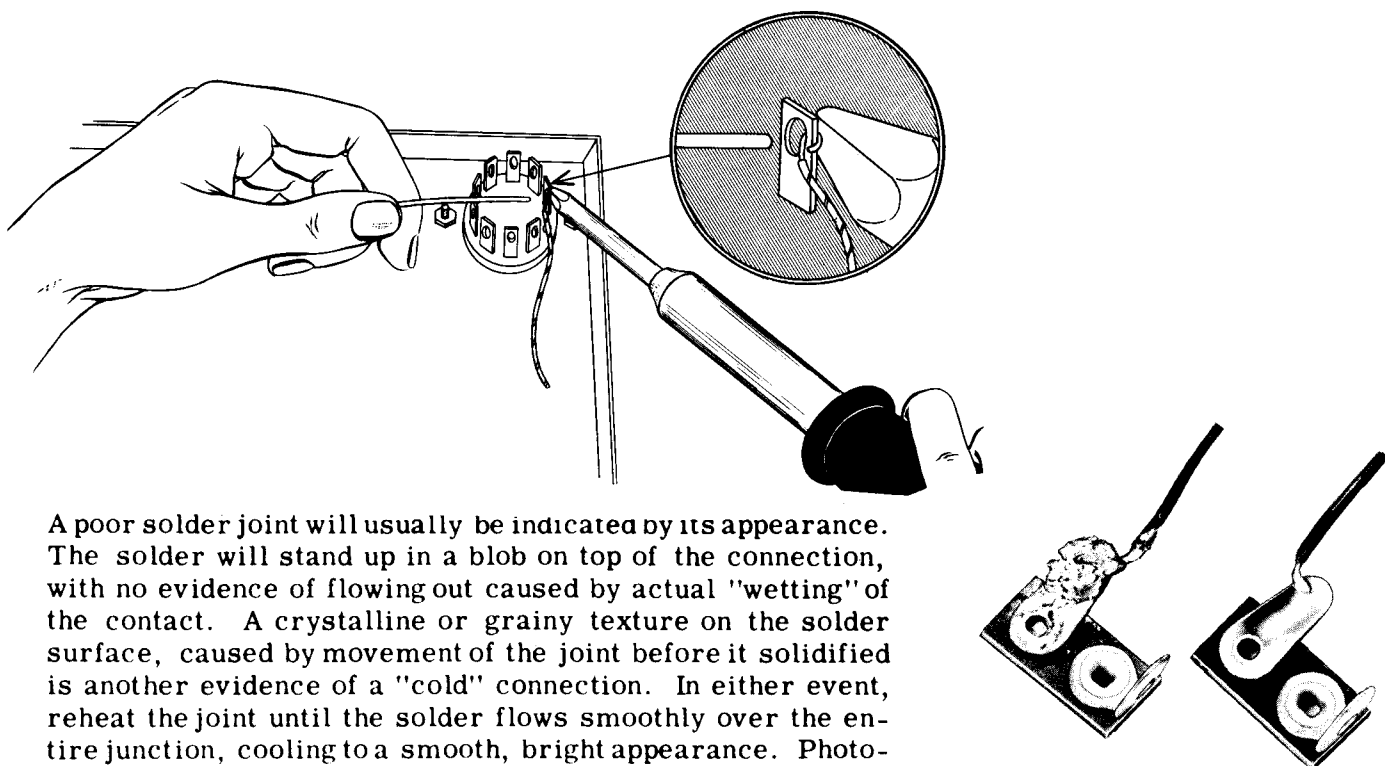

A poor solder joint will usually be indicated by its appearance. The solder will stand up in a blob on top of the connection, with no evidence of flowing out caused by actual "wetting" of the contact. A crystalline or grainy texture on the solder surface, caused by movement of the joint before it solidified is another evidence of a "cold" connection. In either event, reheat the joint until the solder flows smoothly over the entire junction, cooling to a smooth, bright appearance. Photographs in the adjoining picture clearly indicate these two characteristics.

STEP-BY-STEP ASSEMBLY INSTRUCTIONS

Attach the large fold-in pictorials to the wall above your work space. The small reproduction in the manual is intended for reference later on after the large copy has become mutilated or lost.

Leads on condensers and resistors are usually much longer than they need to be. These leads should be cut to the proper length as the parts are wired into place. This will result in both superior operation and neater appearance. Use insulated sleeving on bare wires of condensers and resistors where necessary to prevent the leads from accidentally touching bare wires or metal parts. Use lockwashers under all nuts unless otherwise specified.

Check off each step in the space provided () as it is completed.

(S) means solder the connection.

(NS) means do not solder yet.

POWER SUPPLY

- () Mount the two condenser mounting wafers PB and PC on top of the chassis as shown in Pictorial 1, with 6-32 screws and nuts. Note the position of the triangular cutout. Under the chassis, include a 1-lug terminal strip PA under the nut indicated.
- () Mount the V5 octal tube socket and the similar connector socket from below the chassis with 6-32 screws and nuts. Observe that the keyways in the sockets are pointed inward toward each other. Place one solder lug under the top nut and two under the bottom nut. Position as shown in Pictorial 1.
- () Mount the 110 volt socket PD from below the chassis with 6-32 screws and nuts.
- () Mount the fuse holder PE with the nut and lockwasher supplied and install the fuse. When necessary, replace with a type 3AG rated at not more than 3 amperes.

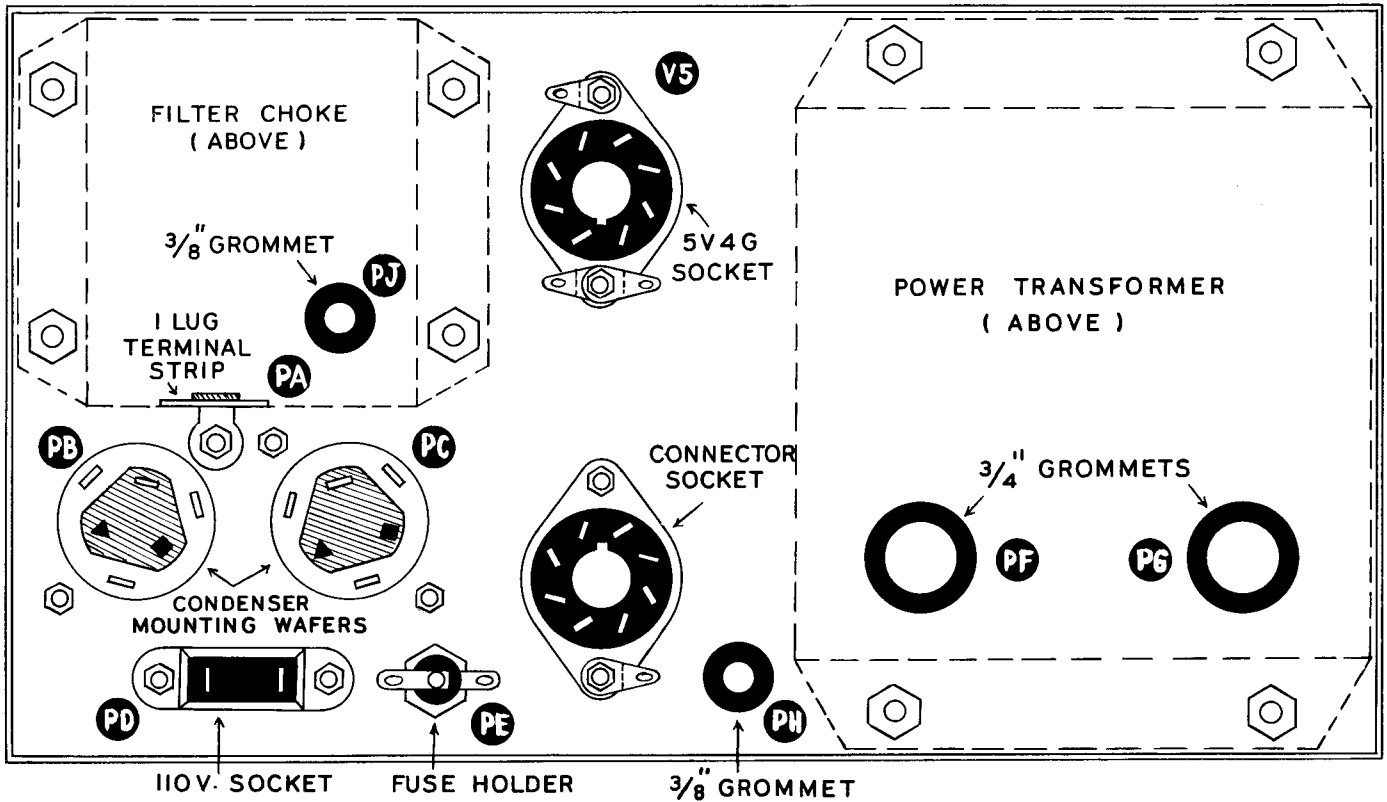

POWER SUPPLY CHASSIS LAYOUT — BOTTOM VIEW

PICTORIAL 1

- () Install the two 3/8" grommets PH and PJ for the line cord and the filter choke and the two 3/4" grommets PF and PG for the transformer leads.
- () Mount the power transformer on top of the chassis with the leads through the 3/4" grommets. Use 8-32 screws and nuts.
- () Mount the filter choke on top of the chassis with the leads through the 3/8" grommet. Use 8-32 screws and nuts.
- () Install the two 50 μ fd 350 volt electrolytic condensers at PB and PC. Observe the position of the lugs in the sketch and install from the top of the chassis by passing the mounting prongs through the slots in the wafer. After making sure that the condenser is snugly seated against the wafer, twist each of the mounting prongs 1/8 of a turn with a pair of pliers.

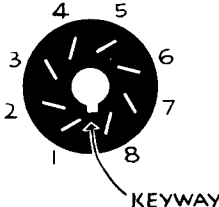
- () Twist together the transformer leads that come from grommet PG and place to tube socket V5. After cutting each wire to length and stripping the insulation off the ends, connect the red-yellow lead to the ground lug (S) on the V5 socket. See Pictorial 2.
 - () Connect one red lead to pin 6 (S) on V5.
 - () Connect the other red lead to pin 4 (S) of V5.
 - () Connect one yellow lead to pin 2 (S) of V5.
 - () Connect the other yellow lead to pin 8 (NS) of V5.
- Figure 1
- 
- () Twist together the black transformer leads from grommet PF and place to the 110 volt socket PD.
 - () After cutting the leads to length and stripping the insulation off the ends, connect one black lead to one socket lug (NS) and the other black lead to the other socket lug (NS).
 - () Twist together the remaining transformer leads that come from grommet PF and place them to the connector socket.
 - () After cutting the leads to length and stripping the insulation from the ends, connect one green lead to pin 1 (S) on the connector socket.
 - () Connect the other green lead to pin 2 (S) on the connector socket.
 - () Connect the green-yellow lead to the ground lug (NS) at the connector socket. (IMPORTANT: If the Heathkit Preamplifier WA-P2 is to be used with this amplifier, tape the green-yellow lead and leave it free. This applies to supplying filament power to any preamplifier which incorporates a filament balance control for hum reduction.)
 - () Connect a piece of bare wire between pin 3 (S) and the ground lug (S) at the connector socket.

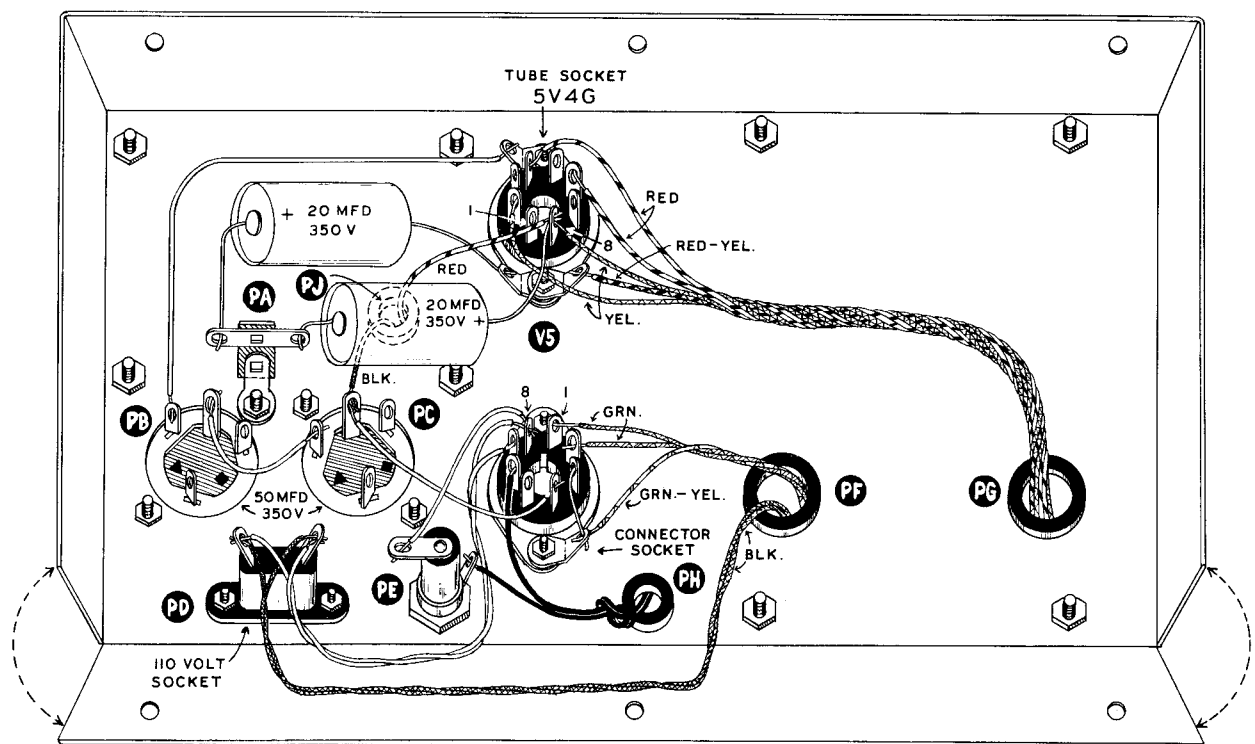

POWER SUPPLY PICTORIAL

- () Twist two wires together and connect one pair of ends to socket PD with one wire to one lug (S) and the other wire to the other lug (S).
- () Connect the other ends to the connector socket pin 7 (S) and pin 8 (NS).
- () Connect a wire from pin 8 (S) on the connector socket to the end lug (S) on the fuse holder .
- () Connect a wire from pin 4 (S) on the connector socket to the center lug on condenser PC (NS).
- () Connect the black lead from the filter choke to the center lug on condenser PC (S).
- () Connect the red lead from the filter choke to pin 8 (NS) on V5.
- () Connect the positive (+) lead of a 20 μ fd 350 volt electrolytic condenser to pin 8 (S) of V5 and the other lead to terminal strip PA (S).
- () Connect the positive lead of another 20 μ fd 350 volt electrolytic condenser to terminal strip PA (S) and the other lead to the ground lug (S) at V5.
- () Connect a wire between a twisted mounting prong (S) on condenser PC and the center lug (S) on condenser PB.
- () Connect a wire between a twisted mounting prong (S) on condenser PB and a ground lug (S) at socket V5.
- () Place the end of the line cord through grommet PH from the top of the chassis and tie a knot for strain relief so it cannot be pulled out.
- () Connect one wire of the line cord to the side lug (S) of fuse holder PE and the other wire to pin 6 (S) on the connector socket.
- () Check the wiring very carefully against the pictorial and make sure each connection is properly soldered. Shake out any excess solder and loose short pieces of wire.
- () Install the four rubber feet in one of the bottom plates as shown in Figure 2. Attach this plate to the bottom of the chassis with six #6 sheet metal screws.
- () Install the 5V4G tube in socket V5 between the power transformer and the filter choke.

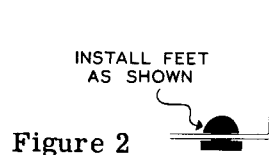

AMPLIFIER

- () Mount the five octal saddle sockets on the chassis at V1, V2, V3, V4 and for the connector socket using 6-32 hardware. Be sure that the keyways are positioned as shown in Pictorial 3.
- () Mount the phono socket at K from below the chassis, using 6-32 hardware. Install a 1-lug terminal strip (KK) between the phono socket and one lockwasher, orienting it as shown in Pictorial 3.

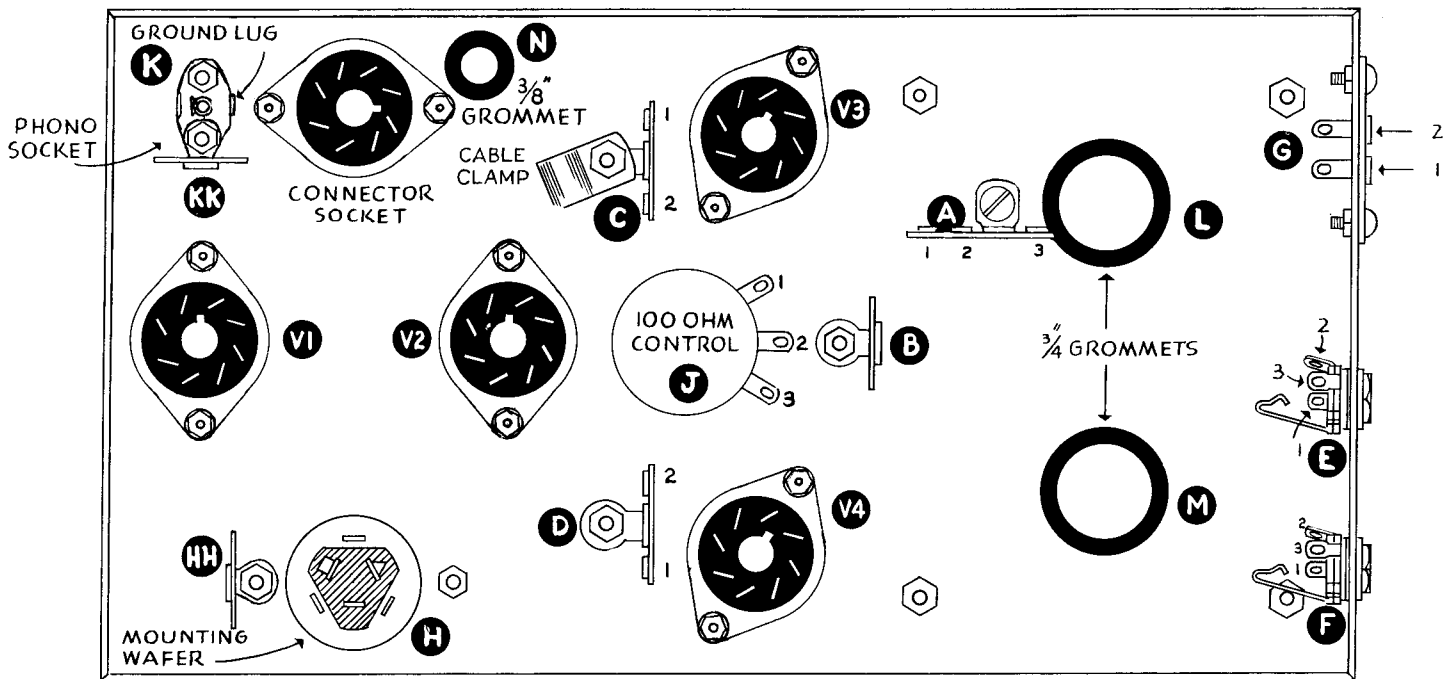

AMPLIFIER CHASSIS LAYOUT · · *Bottom View*

PICTORIAL 3

- () At H, install a condenser mounting wafer on top of the chassis, using 6-32 hardware. Place a 1-lug terminal strip (HH) under one of the lockwashers. Note the position of both the terminal strip and the three mounting slots.
- () Mount the 2-screw speaker terminal strip at G on the end of the chassis using 6-32 hardware.
- () Mount a 3-lug terminal strip at A, using a #6 sheet metal screw.
- () Insert the two 3/4" grommets in the large holes at L and M.
- () Mount a 1-lug terminal strip under the chassis at B, using 6-32 hardware.
- () Mount a 2-lug terminal strip D near socket V4 under the chassis, with a 6-32 screw and nut.
- () Mount the output transformer on top of the chassis, using 8-32 screws, lockwashers and nuts. Be sure the group of four leads comes through the grommet L.
- () Mount the 100 Ω control from below the chassis at position J. Use a control lockwasher between the control bushing and the underside of the chassis, and a flat steel washer under the control nut.
- () Install the 3/8" grommet at position N.
- () Use a length of 8-wire cable (not longer than three feet) for connection between amplifier and power supply. Note that if the installation requires a longer cable between these two units, other cable should be obtained locally. For a distance not exceeding three feet, the cable supplied with the kit (all wires #22 gauge) is suitable. For a distance not exceeding four feet, an 8-wire cable with at least two #20 gauge wires may be used. For a distance not exceeding six feet, a cable with two #18 gauge wires (such as Belden #8448) may be used. For distances up to nine feet, two conductors in the cable should be #16 gauge.

- () Remove the overall insulation (plastic or braid) on one end for a distance of a good 6" and place this end through grommet N. Bend open the 3/16" plastic cable clamp and slip it around the cable at the point where the overall insulation ends.
- () Install the 2-lug terminal strip C together with the cable clamp, using the long 6-32 screw and nut.
- () Mount the jacks E and F on the end of the chassis. Use an insulated shoulder washer between jack bushing and chassis and an insulated flat washer under the nut.
- () Mount the 20-20 μ fd 450 volt, 20 μ fd 25 volt electrolytic condenser on top of the chassis by passing the mounting prongs through the slots in the mounting wafer. Make sure the unmarked lug is toward the edge of the chassis and while holding the condenser snugly against the wafer, twist each of the mounting prongs 1/8 turn with pliers.

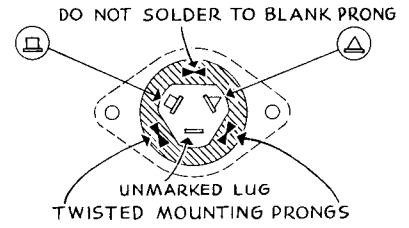
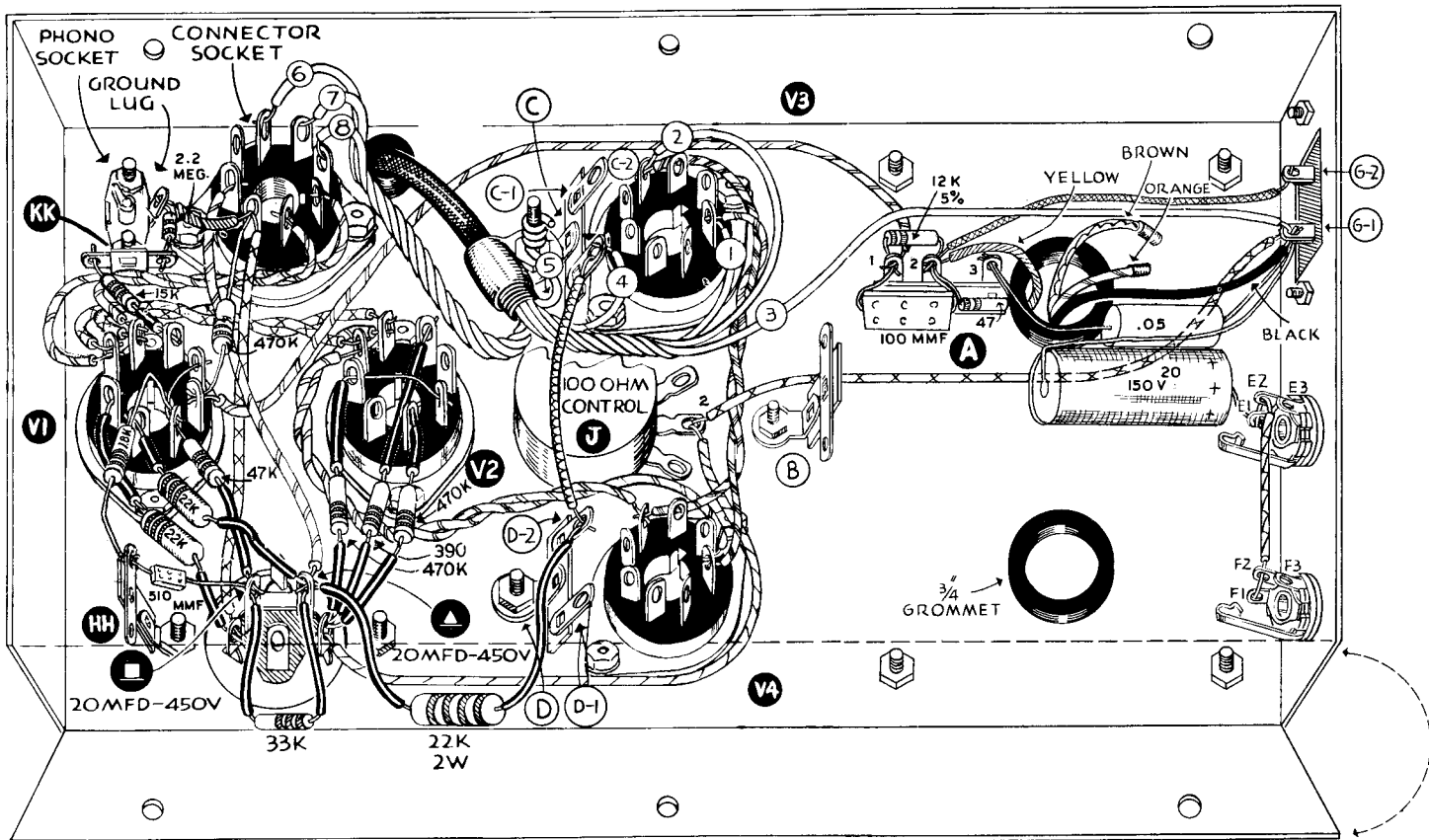

Figure 5

- () Cut the wires from the cable to length required and strip the insulation off the ends. With the cable supplied with this kit, no special attention need be paid to which wire goes where at this point, but if a cable with two larger conductors is used, these larger wires should be numbers 1 and 2. Connect wire ① to pin 2 (NS) on socket V3. See Pictorial 4.
- () Connect wire ② to pin 7 (NS) on V3.
- () Connect wire ③ to lug G1 (NS) on the 2-screw terminal strip.
- () Connect wire ④ to terminal strip C2 (NS).
- () Wrap wire ⑤ which is not used, around the long screw that holds the cable clamp. This wire may be considered a spare.



- () Connect wire ⑥ to pin 6 (S) on the connector socket.
- () Connect wire ⑦ to pin 7 (S) on the connector socket.
- () Connect wire ⑧ to pin 8 (S) on the connector socket.
- () Twist two wires together and at one end connect one wire to pin 2 (S) and the other to pin 7 (S) on socket V3.
- () At the other end of the twisted pair, connect one wire to pin 2 (NS) and the other wire to pin 7 (NS) on socket V4.
- () Twist another pair of wires together and on one end connect one wire to pin 2 (S) and the other to pin 7 (S) on socket V4.
- () At the other end of this twisted pair, connect one wire to pin 7 (NS) and the other to pin 8 (NS) on socket V2.
- () In the same manner, connect pins 7 (S) and 8 (S) on socket V2 to pins 7 (NS) and 8 (NS) on socket V1.
- () In the same manner, connect pins 7 (S) and 8 (S) on socket V1 to pins 1 (S) and 2 (S) on the connector socket.
- () Connect the black lead from the output transformer to terminal strip G1 (NS).
- () Connect a wire from terminal strip G1 (NS) to the center lug (NS) on control J.
- () Connect a wire between the center lug (S) on control J and the nearest twisted mounting prong (NS) on condenser H.
- () Connect a wire between the other twisted mounting prong (NS) on condenser H and pin 3 (NS) on the connector socket.
- () Connect a short wire between pin 3 (NS) on the connector socket and the ground lug (NS) on phono socket K.
- () Connect a 2.2 megohm resistor (red-red-green) between the ground lug (S) on phono socket K and terminal strip KK (NS).
- () Install a 15 K Ω resistor (brown-green-orange) between terminal strip KK (S) and pin 1 (S) of V1 (use sleeving).
- () Connect a 470 Ω resistor (yellow-purple-brown) between pin 3 (S) on the connector socket and pin 3 (NS) on socket V1.
- () Connect a 470 K Ω resistor (yellow-purple-yellow) between pin 1 (NS) on socket V2 and the nearest twisted mounting prong (NS) on condenser H (use sleeving).

NOTE: One of the twisted mounting prongs has not been pierced and should not be used as a terminal. This prong should be disregarded.

- () Connect a 390 Ω resistor (orange-white-brown) with one lead through pin 6 (NS) to pin 3 (S) on socket V2 and the other lead to the nearest twisted mounting prong (NS) on condenser H (use sleeving). Now solder pin 6.
- () Connect a 470 K Ω resistor (yellow-purple-yellow) between pin 4 (NS) on socket V2 and the twisted mounting prong (S) on condenser H (use sleeving).

NOTE: In the following instructions, the term "matched pair" refers to the two pair of resistors separately packed and so marked in your kit. These consist of one pair of 22 K Ω 1 watt resistors (red-red-orange) and one pair of 47 K Ω 2 watt resistors (yellow-purple-orange). These pairs are carefully matched to each other for equal resistance and should be used only where indicated to obtain maximum performance from the amplifier.

- () Connect one of the matched pair of 22 K Ω 1 watt resistors (red-red-orange) between pin 6 (NS) on socket V1 and the nearest twisted mounting prong (S) on condenser H (use sleeving).
- () Connect a wire to pin 4 (S) on the connector socket and to the \blacktriangle marked lug (NS) on condenser H.
- () Connect a 47 K Ω 1/2 watt resistor (yellow-violet-orange) (do NOT use one of the large 2 watt matched pair) with one lead through pin 4 (NS) to pin 2 (S) on socket V1. Connect the other lead to the \blacksquare marked lug (NS) on condenser H. Make sure there is adequate clearance around pin 3 of the socket (use sleeving).
- () Connect a 33 K Ω resistor (orange-orange-orange) between the \blacksquare marked lug (NS) and the \blacktriangle marked lug (NS) on condenser H (use sleeving).
- () Connect the other 22 K Ω 1 watt resistor (red-red-orange) of the matched pair between pin 5 (NS) on socket V1 and the \blacktriangle marked lug (NS) on condenser H (use sleeving).
- () Connect a 22 K Ω 2 watt resistor (large red-red-orange) between the \blacktriangle marked lug (S) on the condenser and lug D2 (NS) on the terminal strip (use sleeving).
- () Connect a wire between lug D2 (NS) and lug C2 (NS).
- () Connect a wire from pin 3 (S) on socket V1 to lug A1 (NS).
- () Connect the 12 K Ω resistor (brown-red-orange) between A1 (NS) and A2 (NS).
- () Install the 100 μmf condenser (the larger of the two mica condensers) between A1 (S) and A2 (NS).
- () Connect a .05 μf 200 volt condenser between A3 (NS) and G1 (NS). Note its position in Pictorial 4.
- () Connect a 47 Ω resistor (yellow-violet-black) between A2 (NS) and A3 (S).
- () Connect the yellow wire from the output transformer to A2 (S).
- () Make one of the following connections, depending upon the impedance of your speaker system:
 - For 4 Ω output, connect the brown lead from the transformer to G2 (S).
 - For 8 Ω output, connect the orange lead from the transformer to G2 (S).
 - For 16 Ω output, connect a lead from A2 (already soldered) to G2 (S).

Lead not used should be taped at the end and wrapped around bracket of terminal strip A.

- () Connect a wire with one end through lug F2 (S) to lug F1 (S) and with the other end through lug E2 (S) to lug E1 (NS) on the phone jacks.
- () Connect a .05 μfd tubular condenser from terminal strip KK (S) to center lug (S) on phono socket K. See Pictorial 5. NOTE: Tubular paper capacitors may or may not be marked by a band indicating "outside foil." Marked or not however, the capacitors may be connected either way in this circuit since the "polarity" is not critical.
- () Connect the blue lead from the output transformer to pin 3 (S) on socket V3.

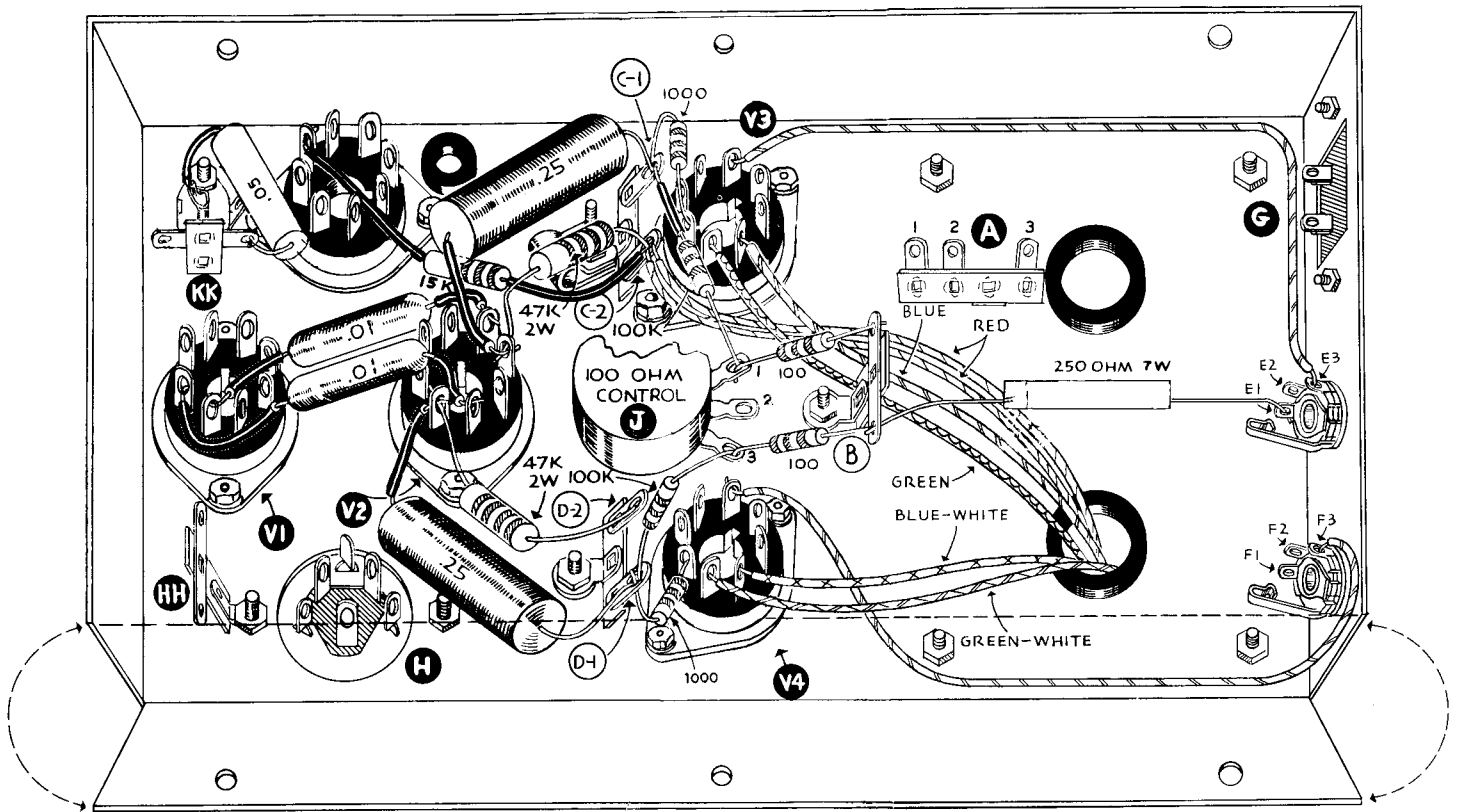

PICTORIAL 5

- * () Connect the green lead from the transformer to pin 4 (S) on socket V3.
- () Connect the blue-white lead from the output transformer to pin 3 (S) on socket V4.
- * () Connect the green-white lead from the output transformer to pin 4 (S) on socket V4.
- () Connect the TWO red leads from the output transformer to C2 (NS).
- () Connect a wire between pin 8 (S) on socket V4 and lug F3 (S).
- () Connect a wire between pin 8 (S) on socket V3 and lug E3 (S).
- () Connect the 250 Ω 7 watt resistor between lug E1 (NS) and the 1-lug terminal strip B (NS).
- *Read NOTE on Page 22 for Optional Circuit.
- () Connect the positive lead of a 20 μ fd condenser to E1 (S). Connect the other lead of this condenser to G1 (S). Refer to Pictorial 4 for proper placement.
- () Connect a 100 Ω resistor (brown-black-brown) between terminal strip B (S) and lug 3 on control J (NS).
- () Connect a 100 K Ω resistor (brown-black-yellow) between lug 3 (S) on control J and lug D1 (NS) (use sleeving).
- () Connect a 1 K Ω resistor (brown-black-red) between lug D1 (NS) and pin 5 (S) on socket V4.
- () Connect a 100 Ω resistor (brown-black-brown) between terminal strip B (S) and control lug J1 (NS).
- () Connect a 100 K Ω resistor (brown-black-yellow) between control lug J1 (S) and lug C1 (NS) (use sleeving).

- () Connect a 1 K Ω resistor (brown-black-red) between lug C1 (NS) and pin 5 (S) on socket V3.
- () Connect the 15 K Ω 1 watt resistor (brown-green-orange) from pin 5 of the connector socket (S) to C2 (NS). Use sleeving on both leads and place the body of the resistor directly against the chassis below the .25 mfd. condenser.
- () Connect one of the matched pair of 47 K Ω 2 watt resistors (large yellow-purple-orange) between lug C2 (S) and pin 2 (NS) on socket V2.
- () Connect a .25 μ fd (large tubular) condenser between pin 2 (S) on socket V2 and lug C1 (S) (use sleeving). Again note that "outside foil," if marked, may be disregarded.
- () Connect the other 47 K Ω 2 watt resistor (large yellow-purple-orange) of the matched pair between lug D2 (S) and pin 5 (NS) on socket V2.
- () Connect a .25 μ fd condenser between pin 5 (S) on socket V2 and lug D1 (S) (use sleeving).
- () Connect a .01 μ fd 400 volt condenser between pin 5 (S) on socket V1 and pin 1 (S) on socket V2 (use sleeving).
- () Connect a .01 μ fd 400 volt condenser between pin 6 (S) on socket V1 and pin 4 (S) on socket V2 (use sleeving).
- () Connect a 1.8 K Ω resistor (brown-gray-red) between pin 4 (S) of socket V1 and terminal strip HH (NS) (use sleeving).
- () Connect the 510 μ fd mica condenser between terminal strip HH (S) and the ■ marked lug (S) on condenser H.
- () Install the octal plug on the end of the cable. Remove the overall insulation for about 1 1/2". Remove the insulation from each wire for about 3/4". Slip the plug cap on the cable with the grommet toward the chassis end. Arrange the wires in a circle and slip wire ① in the hole marked 1, wire ② in the hole marked 2, etc. Make sure the wire sticks out beyond the pin. Bend the wire over to keep it from slipping out. See Figure 6.

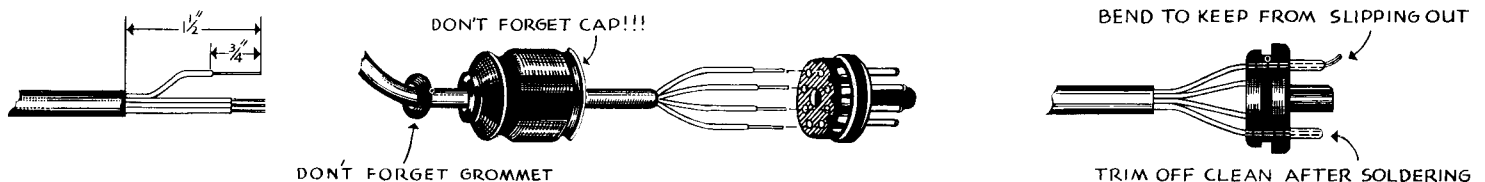

Figure 6

- () Solder the wire in each pin by heating the pin with the soldering iron and letting the solder flow up into the pin. See that no excess solder sticks to the outside of the pin. If necessary reheat the pin and wipe off excess solder with a cloth.
- () Cut off the bent over portions of wire leaving a clean pin.
- () Press the cap over the plug so it snaps into place. When removing this plug from the power supply, never pull on the cable. Always use the plug cap for a handle.
- () Check the wiring very carefully against both pictorials and make sure each connection is properly soldered. Shake out any excess solder and loose short pieces of wire.

TESTING THE COMPLETED AMPLIFIER

This amplifier is designed for operation from signal sources that are equipped with volume and tone controls such as some AM and FM tuners, tape reproducers or record players have.

For signal sources without volume and tone controls, the use of a preamplifier is recommended.

If the Heathkit WA-P2 Preamplifier was not purchased with the unit, procure a standard octal connector plug and cap, similar to Amphenol's 86-PM8, from a local source. This connector is used to make the following voltages and control circuits available for use with auxiliary equipment.

Pins 1 and 2	6.3 volts 1.0 amperes AC
Pin 3	Negative plate supply
Pin 4	Positive plate supply (200 volts 10 ma DC)
Pin 5	Not used
Pins 6 and 7	115 volts AC from power line
Pins 6 and 7	Line switch, to control amplifier and AC outlet on amplifier chassis

Before the amplifier can be tested, connections should be made to the auxiliary equipment as shown above or a jumper must be connected between pins 6 and 7 on the connector plug.

The output stage should now be adjusted for equal currents in the 5881 tubes.

Connect the loudspeaker leads to the speaker terminals on the amplifier chassis.

If the following testing components are not on hand, they can probably be borrowed from a friend or a local radio service man can make the adjustment in a few minutes. If desired, the essential parts can be obtained locally or from one of the large mail-order radio parts companies for less than \$2.00. Their possession in case of tube replacement or balance checks after prolonged use may be well worth the small outlay. A pocket tester, such as the Heathkit Handitester would be more convenient for a multitude of tests in case of operating difficulties and should prove of value to the technically inclined constructor.

Connect a DC milliammeter with a range of not less than 60 milliamperes full scale (preferably 0-100 milliamperes) to a phone plug. Connect the positive (+) terminal of the meter to the center connection of the phone plug (tip) and the other meter terminal to the outer connection of the phone plug (sleeve).

Plug the line cord from the amplifier into a 105-125 volt 50/60 cycle AC (alternating current) outlet. **CAUTION: DO NOT PLUG INTO A DC (DIRECT CURRENT) OUTLET**, such as is found in some of the older districts of the bigger cities. DC will cause the fuse to break the circuit and prevent damage. This amplifier will not operate on DC or 25 cycle AC and replacing the fuse will be to no avail.

Turn the amplifier on. Observe the filaments in the tubes. If they light up, the filament circuits are functioning correctly. The speaker should now produce some background noise. This indicates that the amplifier appears to be functioning normally.

Insert the phone plug that is connected to the meter into one of the phone jacks on the amplifier. The meter should indicate between 40 and 60 milliamperes. Note the reading and insert the plug into the other jack. Adjust the control between the 5881 tubes with a screwdriver until both readings are alike.

If the signal source (record player or tuner) is not already equipped with a phono plug of the type supplied with this kit, install a phono plug on the output lead of the signal source as shown.

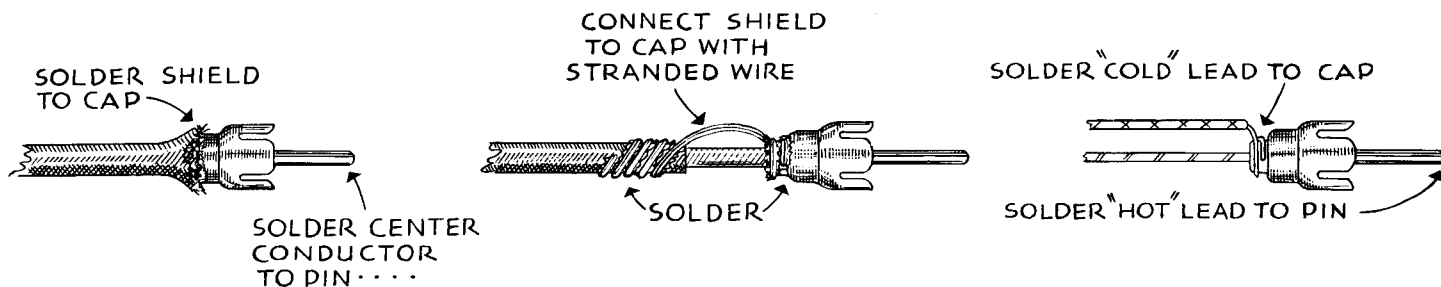

Figure 7

IN CASE OF DIFFICULTY

If the initial test does not produce the desired results, proceed as follows:

1. Make sure that all the tubes light up properly. Make sure the tubes are in their proper sockets. Test the tubes.
2. Have a friend check the wiring against the pictorials. Mistakes in wiring are much more easily located by another person.
3. Check the operating voltages with a meter. All measurements are made between tube pins and chassis. The voltages should check within 20% of the values listed below, if a vacuum tube voltmeter (VTVM) with 11 megohms input resistance is used. With a voltohmmeter (VOM) of 1000 or 20,000 Ω per volt sensitivity, some readings may be considerably less. If a reading is found to differ appreciably from the tabulated value, check into that part of the circuit to locate the source of difficulty. This can be done, for instance, by checking the resistance of the resistors and testing the condensers for opens or shorts. All measurements made without preamplifier.

VOLTAGE CHART

SOCKET TUBE TYPE	Pin 1	Pin 2	Pin 3	Pin 4	Pin 5	Pin 6	Pin 7	Pin 8
V1 6SN7	0	50	1	50	200	60	3 VAC	3 VAC
V2 6SN7	0	140	3.5	0	140	3.5	3 VAC	3 VAC
V3 - V4 5881	0	3 VAC	415	420	0 to 10	0	3 VAC	36
V5 5V4G		440		405 VAC		405 VAC		440

4. If the amplifier oscillates and produces a loud squeal or motor-boats and makes a putt-putt sound, check for improper positioning of parts and wiring (known as lead dress) and poor solder connections to ground (chassis) or filter condensers. (NOTE: Speaker leads placed close to the unshielded portions of the input leads will readily provide oscillation and acoustic feedback from the speaker back to the turntable and pickup may result in a roar or howl at maximum settings of the volume control.)
5. If a part is believed to be or actually found to be faulty, please write us promptly and we will advise you.
6. Should the procedure as outlined fail to bring the desired results, write to the Heath Company describing the difficulties by giving all possible information, such as sound produced, meter readings obtained and all other pertinent data available. We will attempt to analyze your trouble and advise you accordingly.

IN ALL CORRESPONDENCE, REFER TO THIS KIT AS THE MODEL W-3AM AMPLIFIER. Failure to mention this model number will make it difficult to determine which of the many models produced, both at present and in the past, you are referring to.

OPERATION

Since the W-3AM has no controls, it is operated by the controls on the preamplifier or signal source. Follow the operating instructions for the specific equipment which is used with the amplifier.

APPLICATION AND INSTALLATION

The W-3AM amplifier is designed for high quality sound applications. Such applications require additional components, as a suitable reproducer system and one or more sources of signal. In order to make the fullest use of the quality obtainable from the amplifier, the other components should also be of as high a quality as possible, as the weakest link in the chain will determine the ultimate performance level.

The choice of reproducer depends primarily upon the space available. Excellent results may be obtained from speakers of various sizes, ranging all the way from an 8" to 15" cone diameter. The large speakers generally require a housing or enclosure of greater dimensions. The type of reproducer is also affected by individual taste and generally both the multiple speakers with electrical or mechanical crossover networks, as well as the high grade single cone reproducers are serving satisfied listeners. A further discussion of the problem of speaker selection is beyond the scope of this manual.

The amplifier lends itself to operation directly from signal sources that are equipped with volume and tone controls such as some AM and FM tuners, tape or wire reproducers, or record players have.

For signal sources without volume and tone controls such as simple tuners or record players, the use of a preamplifier is recommended. The Heathkit Preamplifier WA-P2 has been designed especially for this purpose.

The installation depends on the individual requirements. Generally the amplifier will be installed in a cabinet or other enclosure. NOTE: This amplifier system consumes 120 watts of power, which is converted to heat. This heat will produce a temperature rise in the cabinet equal to the effect of two standard 60 watt light bulbs burning in the same space. Adequate ventilation should be provided to permit the heat to escape, thus keeping the temperature from rising too high. High temperature operation may adversely affect the life of some of the components in the amplifier and may also damage the finish of the cabinet.

We do not recommend installation of amplifier and power supply inside the speaker housing. Most types of speaker housings do not permit adequate ventilation and the resulting high temperatures may ruin a good speaker.

When planning the actual installation, keep the following points in mind:

1. Select the location of the speaker so that it is aimed at the listeners.
2. Provide adequate ventilation for the amplifier and power supply.
3. Locate the preamplifier as close to the source and the main amplifier as conveniently possible, to reduce high frequency losses in the shielded cables.
4. Keep the preamplifier and source separated from the speaker to prevent acoustic feedback.

Note that this amplifier is designed for domestic applications and that its use for public address applications is not recommended. The weight is high for the output obtained and the outstanding quality of reproduction available is generally lost because of acoustic conditions.

BIBLIOGRAPHY

The Saturday Review Home Book of Recorded Music and Sound Reproduction, Prentice Hall, Inc., New York
Read, O.; The Recording and Reproduction of Sound, Howard W. Sams and Company, Inc. Indianapolis
Newitt, John H.; High Fidelity Techniques, Rinehart Books, Inc., New York

REPLACEMENTS

Material supplied with Heathkits has been carefully selected to meet design requirements and ordinarily will fulfill its function without difficulty. Occasionally improper instrument operation can be traced to a faulty tube or component. Should inspection reveal the necessity for replacement, write to the Heath Company and supply all of the following information:

- A. Thoroughly identify the part in question by using the part number and description found in the manual parts list.
- B. Identify the type and model number of kit in which it is used.
- C. Mention the order number and date of purchase.
- D. Describe the nature of defect or reason for requesting replacement.

The Heath Company will promptly supply the necessary replacement. Please do not return the original component until specifically requested to do so. Do not dismantle the component in question as this will void the guarantee. If tubes are to be returned, pack them carefully to prevent breakage in shipment as broken tubes are not eligible for replacement. This replacement policy does not cover the free replacement of parts that may have been broken or damaged through carelessness on the part of the kit builder.

SERVICE

In event continued operational difficulties of the completed instrument are experienced, the facilities of the Heath Company Service Department are at your disposal. Your instrument may be returned for inspection and repair for a service charge of \$5.00 plus the cost of any additional material that may be required. **THIS SERVICE POLICY APPLIES ONLY TO COMPLETED INSTRUMENTS CONSTRUCTED IN ACCORDANCE WITH THE INSTRUCTIONS AS STATED IN THE MANUAL.** Instruments that are not entirely completed or instruments that are modified in design will not be accepted for repair. Instruments showing evidence of acid core solder or paste fluxes will be returned not repaired.

The Heath Company is willing to offer its full cooperation to assist you in obtaining the specified performance level in your instrument. Factory repair service is available for a period of one year from the date of purchase or you may contact the Engineering Consultation Department by mail. For information regarding the possible modification of existing kits, the volumes listed in the Bibliography section are recommended. They can be obtained at or through your local library, as well as at any electronic outlet store. Although the Heath Company sincerely welcomes all comments and suggestions, it would be impossible to design, test, evaluate and assume responsibility for proposed circuit changes for specific purposes. Therefore, such modifications must be made at the discretion of the kit builder according to information which will be much more readily available from some local source.

SHIPPING INSTRUCTIONS

Before returning a unit for service, be sure that all parts are securely mounted.

ATTACH A TAG TO THE INSTRUMENT GIVING
NAME, ADDRESS AND TROUBLE EXPERIENCED.

Pack in a rugged container, preferably wood, using at least three inches of shredded newspaper or excelsior on all sides. **DO NOT SHIP IN THE ORIGINAL KIT CARTON AS THIS CARTON IS NOT CONSIDERED ADEQUATE FOR SAFE SHIPMENT OF THE COMPLETED INSTRUMENT.** Ship by prepaid express if possible. Return shipment will be made by express collect. Note that a carrier cannot be held liable for damage in transit if packing, in HIS OPINION, is insufficient.

SPECIFICATIONS

All prices are subject to change without notice. The Heath Company reserves the right to discontinue instruments and to change specifications at any time without incurring any obligation to incorporate new features in instruments previously sold.

WARRANTY

Heath Company warrants that for a period of three months from the date of shipment, all Heathkit parts shall be free of defects in materials and workmanship under normal use and service and that in fulfillment of any breach of such warranty, Heath Company shall replace such defective parts upon the return of the same to its factory. The foregoing warranty shall apply only to the original buyer, and is and shall be in lieu of all other warranties, whether express or implied and of all other obligations or liabilities on the part of Heath Company and in no event shall Heath Company be liable for any anticipated profits, consequential damages, loss of time or other losses incurred by the buyer in connection with the purchase, assembly or operation of Heathkits or components thereof. No replacement shall be made of parts damaged by the buyer in the course of handling or assembling Heathkit equipment.

NOTE: The foregoing warranty is completely void and we will not replace, repair or service instruments or parts thereof in which acid core solder or paste fluxes have been used.

HEATH COMPANY

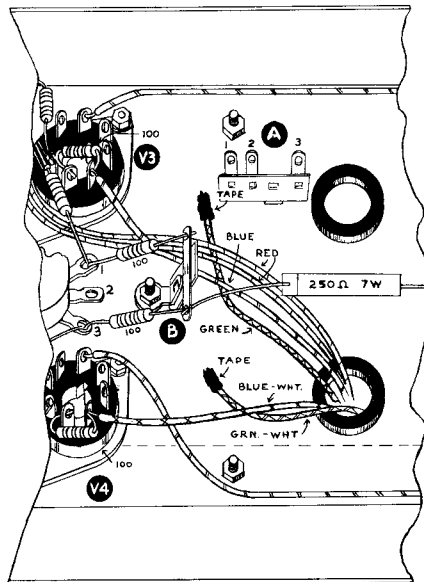

INSTRUCTIONS FOR USING OPTIONAL OUTPUT AMPLIFIER CIRCUIT

If it is desired to utilize the original Williamson type output amplifier circuit, disregard the steps designated by asterisks on Page 12 and substitute the following:

- * () Connect a 100 Ω resistor (brown-black-brown) between pin 4 (S) and pin 3 (S) on socket V3. The green output transformer lead is not used and it should be taped carefully to prevent the bare wire from shorting to another component or the chassis.
- * () Connect a 100 Ω resistor (brown-black-brown) between pin 4 (S) and pin 3 (S) on socket V4. The green-white output transformer lead is not used. It also must be taped carefully.

These connections are shown above. Resistors for wiring the circuit in this way have not been included with this kit.

PARTS LIST

PART No.	PARTS Per Kit	DESCRIPTION	PART No.	PARTS Per Kit	DESCRIPTION
Resistors			Terminal Strips-Wafers		
1-1	1	47 Ω 1/2 watt	431-1	4	1-lug terminal strip
1-3	2	100 Ω 1/2 watt	431-2	2	2-lug terminal strip
1-6	1	470 Ω 1/2 watt	431-3	1	3-lug terminal strip
1-9	2	1 K Ω 1/2 watt	431-6	1	2-screw terminal strip
1-21	1	15 K Ω 1/2 watt	481-4	3	3-prong mounting wafer
1-24	1	33 K Ω 1/2 watt	Sheet Metal Parts		
1-25	1	47 K Ω 1/2 watt	200-M21F	1	Power supply chassis
1-26	2	100 K Ω 1/2 watt	200-M147F	1	Amplifier chassis
1-33	2	470 K Ω 1/2 watt	205-M8F	2	Bottom plate
1-37	1	2.2 megohm 1/2 watt	Wire		
1-48	1	390 Ω 1/2 watt	89-1	1	Line cord
1-93	1	1.8 K Ω 1/2 watt	344-1	1	roll Hookup wire
1-109	1	12 K Ω 5% 1/2 watt	346-1	1	length Sleeving
1-5A	2	22 K Ω 1 watt (matched)	347-1	1	length Cable
1-26A	1	15 K Ω 1 watt	Choke-Transformers		
1-10B	2	47 K Ω 2 watt (matched)	46-12	1	Filter choke
1-11B	1	22 K Ω 2 watt	51-11	1	Output transformer
3-5G	1	250 Ω 7 watt	54-13	1	Power transformer
11-1	1	100 Ω control	Hardware		
Condensers			73-1	3	3/8" grommet
20-38	1	100 $\mu\mu\text{fd}$ mica 5% 500 volt	73-2	4	3/4" grommet
20-42	1	510 $\mu\mu\text{fd}$ mica 5% 500 volt	207-5	1	3/16" cable clamp
23-3	2	.01 μfd 400 v. plastic molded	250-8	13	#6 sheet metal screw
23-24	2	.25 μfd 600 v. plastic molded	250-9	29	6-32 x 3/8 screw
23-59	2	.05 μfd 200 v. plastic molded	250-13	1	6-32 x 1 screw
25-6	1	20-20 μfd 450 volt/20 μfd 25 volt electrolytic	250-17	12	8-32 x 1/4 screw
25-16	2	20 μfd 350 volt electrolytic	252-3	30	6-32 nut
25-17	2	50 μfd 350 volt electrolytic	252-4	12	8-32 nut
25-19	1	20 μfd 150 volt electrolytic	252-7	3	Control nut
Tubes			253-10	3	Nickel washer
411-15	2	6SN7GT	253-15	2	3/8" fiber flat washer
411-35	1	5V4G	253-16	2	3/8" fiber shoulder washer
411-45	2	5881	254-1	30	#6 lockwasher
Sockets-Jacks-Plugs-Fuses			254-2	12	#8 lockwasher
421-2	1	3A fuse	254-4	1	Control lockwasher
423-1	1	Fuse holder	259-1	4	#6 solder lug
434-20	1	110 volt socket	261-1	8	Rubber feet
434-42	1	Phono socket	595-162 1 Instruction manual		
434-58	7	Octal socket, saddle			
436-4	2	Phone jack			
438-4	1	Phono plug			
438-6	1	Octal plug			
440-1	1	Octal plug cap			

HELPFUL KIT BUILDING INFORMATION

Before attempting actual kit construction read the construction manual through thoroughly to familiarize yourself with the general procedure. Note the relative location of pictorials and pictorial inserts in respect to the progress of the assembly procedure outlined.

This information is offered primarily for the convenience of novice kit builders and will be of definite assistance to those lacking thorough knowledge of good construction practices. Even the advanced electronics enthusiast may benefit by a brief review of this material before proceeding with kit construction. In the majority of cases, failure to observe basic instruction fundamentals is responsible for inability to obtain desired level of performance.

RECOMMENDED TOOLS

The successful construction of Heathkits does not require the use of specialized equipment and only basic tools are required. A good quality electric soldering iron is essential. The preferred size would be a 100 watt iron with a small tip. The use of long nose pliers and diagonal or side cutting pliers is recommended. A small screw driver will prove adequate and several additional assorted screw drivers will be helpful. Be sure to obtain a good supply of rosin core type radio solder. Never use separate fluxes, paste or acid solder in electronic work.

ASSEMBLY

In the actual mechanical assembly of components to the chassis and panel, it is important that the procedure shown in the manual be carefully followed. Make sure that tube sockets are properly mounted in respect to keyway or pin numbering location. The same applies to transformer mountings so that the correct transformer color coded wires will be available at the proper chassis opening.

Make it a standard practice to use lock washers under all 6-32 and 8-32 nuts. The only exception being in the use of solder lugs—the necessary locking feature is already incorporated in the design of the solder lugs. A control lock washer should always be used between the control and the chassis to prevent undesirable rotation in the panel. To improve instrument appearance and to prevent possible panel marring use a control flat nickel washer under each control nut.

When installing binding posts that require the use of fiber insulating washers, it is good practice to slip the shoulder washer over the binding post mounting stud before installing the mounting stud in the panel hole provided. Next, install a flat fiber washer and a solder lug under the mounting nut. Be sure that the shoulder washer is properly centered in the panel to prevent possible shorting of the binding post.

WIRING

When following wiring procedure make the leads as short and direct as possible. In filament wiring requiring the use of a twisted pair of wires allow sufficient slack in the wiring that will permit the twisted pair to be pushed against the chassis as closely as possible thereby affording relative isolation from adjacent parts and wiring.













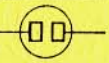













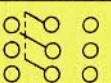

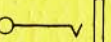

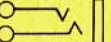

When removing insulation from the end of hookup wire, it is seldom necessary to expose more than a quarter inch of the wire. Excessive insulation removal may cause a short circuit condition in respect to nearby wiring or terminals. In some instances, transformer leads of solid copper will have a brown baked enamel coating. After the transformer leads have been trimmed to a suitable length, it is necessary to scrape the enamel coating in order to expose the bright copper wire before making a terminal or soldered connection.

In mounting parts such as resistors or condensers, trim off all excess lead lengths so that the parts may be installed in a direct point-to-point manner. When necessary use spaghetti or insulated sleeving over exposed wires that might short to nearby wiring.

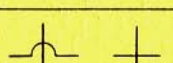
It is urgently recommended that the wiring dress and parts layout as shown in the construction manual be faithfully followed. In every instance, the desirability of this arrangement was carefully determined through the construction of a series of laboratory models.

SOLDERING

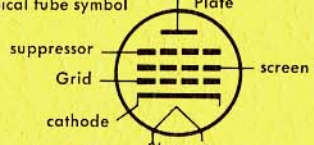
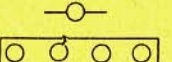
Much of the performance of the kit instrument, particularly in respect to accuracy and stability, depends upon the degree of workmanship used in making soldered connections. Proper soldered connections are not at all difficult to make but it would be advisable to observe a few precautions. First of all before a connection is to be soldered, the connection itself should be clean and mechanically strong. Do not depend on solder alone to hold a connection together. The tip of the soldering iron should be bright, clean and free of excess solder. Use enough heat to thoroughly flow the solder smoothly into the joint. Avoid excessive use of solder and do not allow a flux flooding condition to occur which could conceivably cause a leakage path between adjacent terminals on switch assemblies and tube sockets. This is particularly important in instruments such as the VTVM, oscilloscope and generator kits. Excessive heat will also burn or damage the insulating material used in the manufacture of switch assemblies. Be sure to use only good quality rosin core radio type solder.

Antenna General		Resistor General		Neon Bulb		Receptacle two-conductor	
Loop		Resistor Tapped		Illuminating Lamp		Battery	
Ground		Resistor Variable		Switch Single pole Single throw		Fuse	
Inductor General		Potentiometer		Switch double pole single throw		Piezoelectric Crystal	
Air core Transformer General		Thermistor		Switch Triple pole Double throw		1000 =	K
Adjustable Powdered Iron Core		Jack two conductor		Switch Multipoint or Rotary		1,000,000 =	M
Magnetic Core Variable Coupling		Jack three conductor		Speaker		OHM =	Ω
Iron Core Transformer		Wires connected		Rectifier		Microfarad =	MF
Capacitor General		Wires Crossing but not connected		Microphone		Micro Microfarad =	MMF
Capacitor Electrolytic		A. Ammeter V. Voltmeter		Typical tube symbol  Plate suppressor Grid cathode filament screen	Binding post Terminal strip		
Capacitor Variable		G. Galvanometer MA. Milliammeter uA. Microammeter, etc.			Wiring between like letters is	$\begin{matrix} \downarrow & \downarrow & \downarrow & \downarrow \\ \rightarrow & X & Y & X & Y & X \\ \rightarrow & & & & & \end{matrix}$	understood

HEATH COMPANY

A Subsidiary of Daystrom Inc.

THE WORLD'S FINEST ELECTRONIC EQUIPMENT IN KIT FORM

BENTON HARBOR, MICHIGAN