

Assembly  
and  
Operation  
of the



# SOLID-STATE METRONOME

MODEL TD-17



## TABLE OF CONTENTS

Introduction. . . . .	2
Parts List. . . . .	2
Step-By-Step Assembly	
Circuit Board Assembly. . . . .	3
Front Panel Assembly. . . . .	5
Final Wiring. . . . .	6
Test And Calibration. . . . .	7
Final Assembly. . . . .	9
Operation. . . . .	10
In Case Of Difficulty. . . . .	11
Troubleshooting Chart. . . . .	11
Specifications. . . . .	12
Factory Repair Service. . . . .	12
Circuit Description. . . . .	13
Circuit Board X-Ray Views. . . . .	14
Replacement Parts Price List. . . . .	15
Schematic. . . (fold-out from page). . . . .	15

HEATH COMPANY  
BENTON HARBOR, MICHIGAN 49022

## INTRODUCTION

The Heathkit Solid-State Metronome, Model TD-17, is a tempo-teaching aid for music students. It is continuously variable from 40 to 210 beats per minute, and calibrated in 5 beats-per-minute steps. Volume is variable from a soft thumping to a loud clicking. The Metronome is furnished with an attractive, cherry-finished cabinet made of birch solids and veneers.

The kit can be easily assembled in an hour or two. Most parts are mounted on a single circuit board. The only tools required are a soldering iron, scissors, screwdriver, wire cutters, and pair of pliers.

Power is furnished by two long-life 9 volt batteries, NEDA type 1602.

The Metronome's impressive appearance matches its reliable performance. This kit is certain to give you many years of satisfactory service.

**NOTE:** Refer to the "Kit Builders Guide" for complete information on unpacking, parts identification, tools, wiring, soldering, and step-by-step assembly procedures.

## PARTS LIST

**NOTE:** The numbers in parentheses are keyed to the numbers on the Parts Pictorial (fold-out from Page 3).

To order replacement parts, refer to the "Replacement Parts Price List" and use the Parts Order Form furnished with this kit.

PART No.	PARTS Per Kit	DESCRIPTION	PART No.	PARTS Per Kit	DESCRIPTION
<b>GENERAL</b>			<b>General (cont'd.)</b>		
1-45	1	220 $\Omega$ 1/2 watt resistor (red-red-brown)	(6) 209-59	1	Plastic grille
1-9	1	1000 $\Omega$ 1/2 watt resistor (brown-black-red)	(7) 263-7	4	Felt foot
(2) 10-201	1	10 k $\Omega$ control	(8) 417-96	1	4JX5E670 transistor
10-244	1	100 k $\Omega$ control	(9) 432-33	2	Battery connector
(3) 19-125	1	50 k $\Omega$ control with SPST switch	462-287	1	Knob
(4) 25-145	1	25 $\mu$ F electrolytic capacitor	85-269-2	1	Circuit board
(5) 40-851	1	Coil	390-283	1	Instruction label
91-188	1	Cabinet	597-308	1	Kit Builders Guide
			597-260	1	Parts Order Form
			391-34	1	Blue and white label
				1	Manual (see front cover for part number)
					Solder

# PARTS PICTORIAL

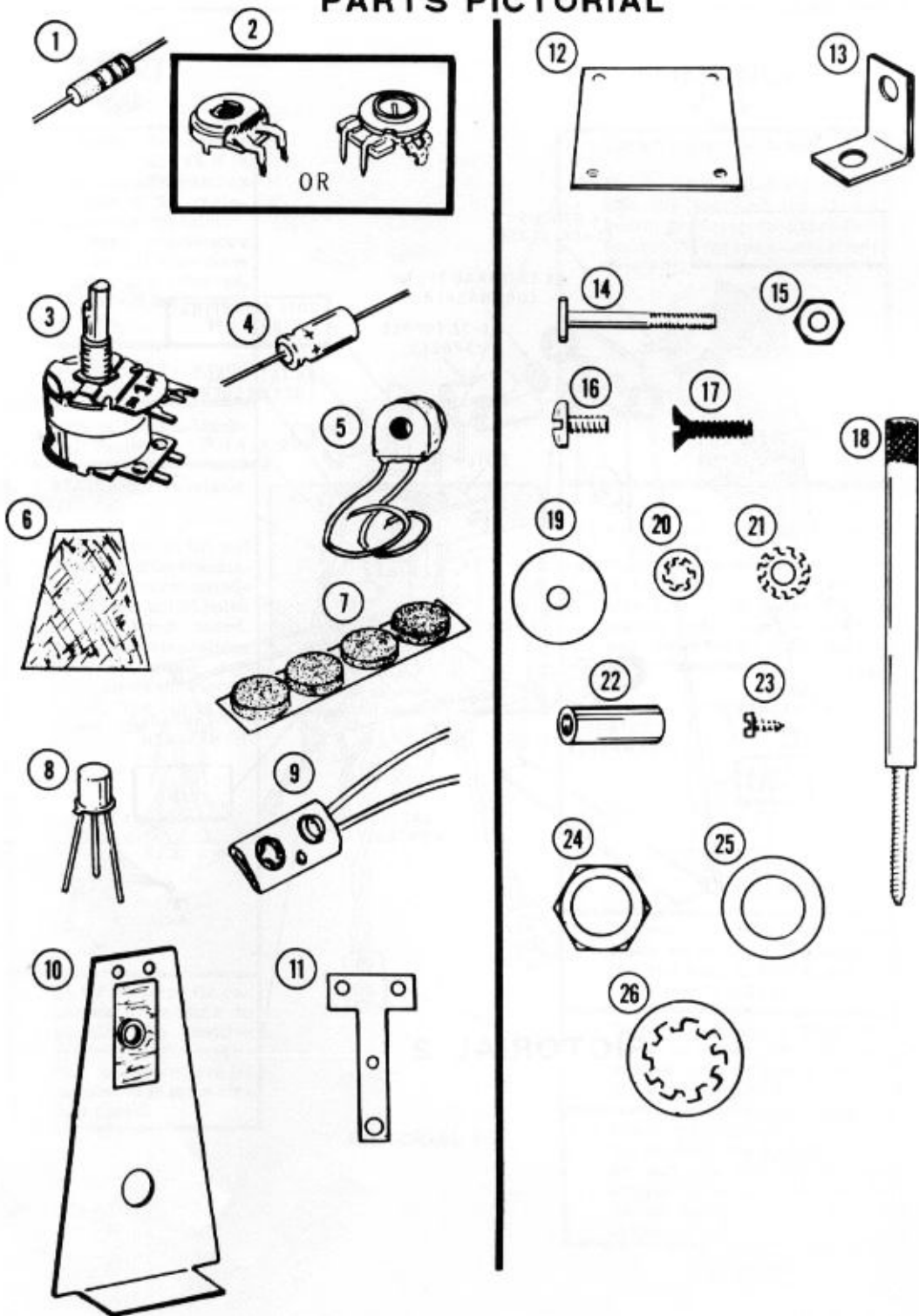

PART No.	PARTS Per Kit	DESCRIPTION
----------	---------------	-------------

**METAL PARTS**

(10) 100-730	1	Front panel
(11) 100-732	1	Coil mounting bracket
(12) 205-730	1	Bottom plate
(13) 204-102	1	Angle bracket

**HARDWARE**
**#5 Hardware**

(14) 250-120	1	5-40 x 7/8" threaded stud
(15) 252-40	1	5-40 nut

**#6 Hardware**

(16) 250-56	2	6-32 x 1/4" screw
(17) 250-276	2	6-32 x 3/8" black screw
(18) 250-394	1	6-32 threaded thumbscrew
(19) 253-21	1	#6 flat washer

PART No.	PARTS Per Kit	DESCRIPTION
----------	---------------	-------------

**#6 Hardware (cont'd.)**

(20) 254-1	2	#6 internal tooth lockwasher
(21) 254-6	3	#6 external tooth lockwasher
(22) 255-94	2	6-32 tapped spacer

**Other Hardware**

(23) 250-355	4	#2 x 3/16" screw
(24) 252-7	1	Control nut
(25) 253-10	1	Control flat washer
(26) 254-4	2	Control lockwasher

NOTE: Two long-life 9 volt batteries, NEDA type 1602 (Eveready #246, Burgess 2N6, or Ray-O-Vac 1602; not furnished with the kit), are required to operate the Metronome. You may wish to obtain the batteries at this time so they will be available when you complete the kit. These batteries will give approximately 300 hours of operation. It is also possible to use two NEDA type 1604 batteries but with greatly reduced life (about 40 hours).

## STEP-BY-STEP ASSEMBLY

Before you start the assembly of this kit, be sure to read the Kit Builders Guide for complete information on wiring, soldering, and step-by-step assembly procedures.

**CIRCUIT BOARD ASSEMBLY**

When installing components on the circuit board, position each part over its outline on the circuit

board as shown in the Pictorial. Follow the instructions carefully and read the entire step before performing the operation.

( ) Locate the circuit board (#85-269-2) and position it lettered side up as shown in Pictorial 1 on Page 4. Then complete each step on Pictorial 1.

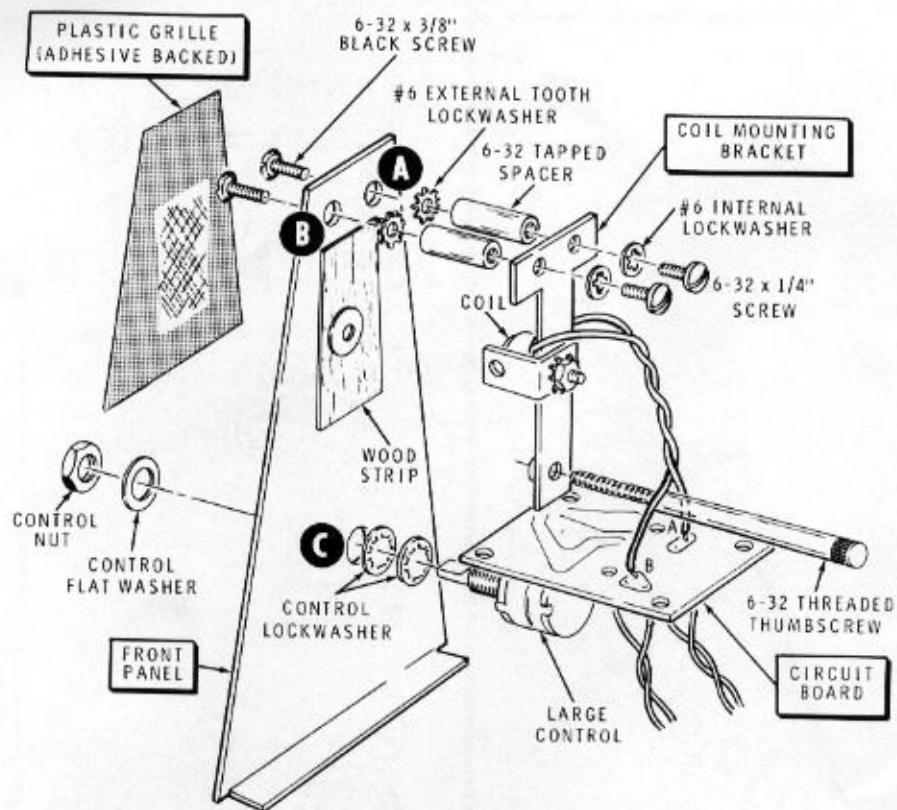

**PICTORIAL 2**

## START

**NOTE:** Solder the connections of each part as it is installed. Cut off the excess lead lengths of the resistors, capacitor, transistor, and battery connectors close to the foil after these connections are soldered. Do not cut off the excess control lugs.

( ) 220  $\Omega$  (red-red-brown) resistor.

( ) 1000  $\Omega$  (brown-black-red) resistor.

( ) 4JX5E670 transistor (#417-96).

Position the E, B1, and B2 leads of the transistor in the corresponding E, B1, and B2 holes of the circuit board. Position the transistor over its outline and 1/4" above the circuit board. The tab is between the E and B2 leads.

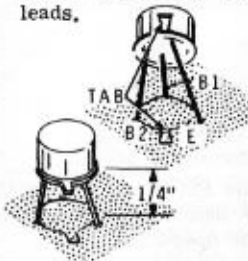

( ) 25  $\mu$ F electrolytic capacitor. Be sure to position the positive (+) lead of the capacitor in the positive (+) marked hole in the circuit board.

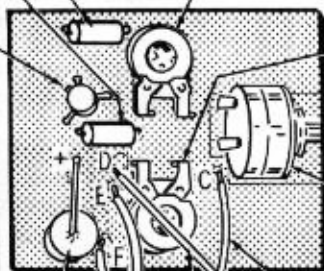

BLK RED  
BLK RED

PICTORIAL 1

## CONTINUE

( ) 100 k $\Omega$  control (#10-244).

Position the lugs of the control into the holes of the circuit board; press the control tightly against the circuit board before soldering the four connections.

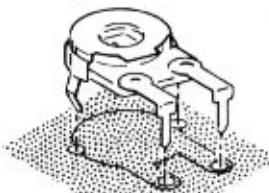

( ) 10 k $\Omega$  control (#10-201). This control has only three soldered connections.

( ) 50 k $\Omega$  control with SPST switch (#19-125). Push the lugs of the control tightly against the circuit board before soldering the five connections.

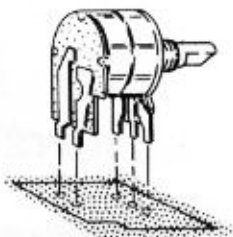

( ) Battery connector: Twist the leads as shown. Then connect the red lead to hole C and the black lead to hole D.

( ) Battery connector: Twist the leads as shown. Then connect the red lead to hole E and the black lead to hole F.

( ) Check to see that all connections are soldered (except holes A and B) and that the excess lead lengths are cut off. Then set the circuit board aside until it is called for later.

## FINISH

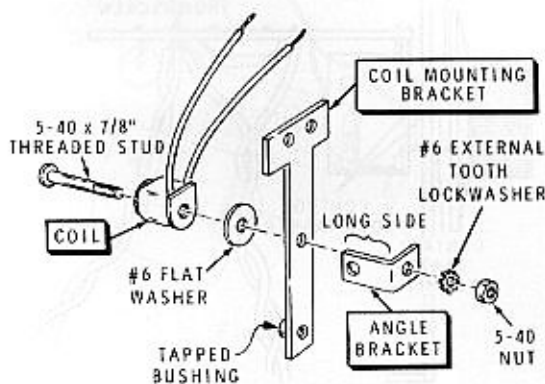
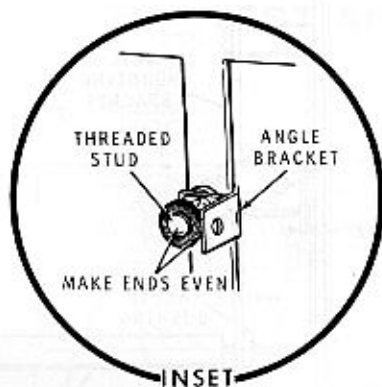

Detail 2A

## FRONT PANEL ASSEMBLY

Refer to Pictorial 2 for the following steps,

- ( ) Refer to Detail 2A and mount the coil and angle bracket on the coil mounting bracket. Use the 5-40 x 7/8" threaded stud, #6 flat washer, #6 external tooth lockwasher, and a 5-40 nut. Note the position of the coil leads and angle bracket with respect to the tapped

bushing in the coil mounting bracket. Be sure to use the proper hole in the angle bracket. Tighten the hardware just enough to make the flat end of the threaded stud even with the end of the angle bracket. See the inset drawing on Detail 2A.

**CAUTION:** Be careful not to damage the wood strip when working with the front panel.

- ( ) Place a soft cloth on your work area to prevent scratching the front panel.
- ( ) Mount 6-32 tapped spacers at locations A and B on the front panel with 6-32 x 3/8" black screws and #6 external tooth lockwashers. Do not tighten the screws at this time. Be sure to mount the spacers on the proper side of the front panel.

**NOTE:** In the following step, be sure the coil mounting bracket is centered properly on the front panel, otherwise, it will be difficult to mount the cabinet later. The coil mounting bracket should be bent, if necessary, so the angle bracket just touches the metal washer on the wood strip.

- ( ) Mount the coil bracket on the spacers at A and B with 6-32 x 1/4" screws and #6 internal tooth lockwashers. Position the coil mounting bracket as shown. Then tighten all four screws while holding the coil against the metal washer on the wood strip.
- ( ) Locate the plastic grille and carefully peel off the protective backing paper.

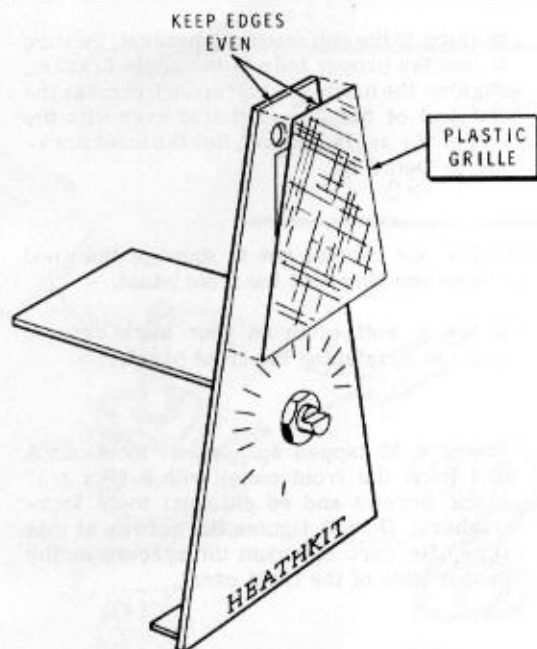

Detail 2B

- ( ) Refer to Detail 2B and press the plastic grille in place on the front panel. Be sure to keep the top and side edges of the grille even with the corresponding edges of the front panel. Do not press in on the center of the grille or you may damage the wood strip.

**NOTE:** When performing the next step, be sure the circuit board is perfectly horizontal and then tighten the control nut securely. If this control moves after the unit is calibrated, the calibration will shift.

- ( ) Now install the circuit board at C on the front panel with two control lockwashers, a control flat washer, and a control nut on the large control. Position the circuit board as shown and tighten the control nut.

## FINAL WIRING

**NOTE:** When making a connection to the foil side of the circuit board, as in the next steps, leave the insulation of the leads  $1/8$ " away from the foil. This will insure a good solder connection to the lead and foil.

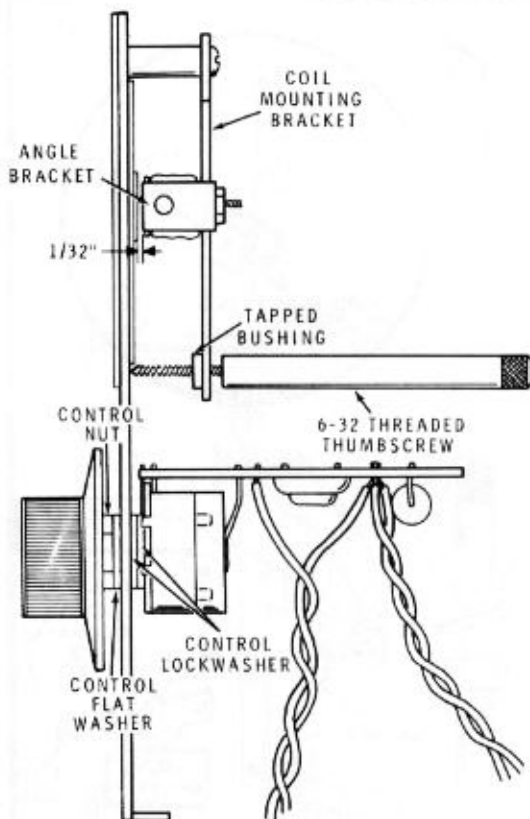

Detail 2C

- ( ) Twist the coil leads together and connect either wire to hole A (S-1) and the other coil wire to hole B (S-1) on the foil side of the circuit board. Position the leads as shown.
- ( ) Refer to Detail 2C and install the 6-32 threaded thumbscrew into the tapped bushing of the coil mounting bracket. Turn the thumbscrew until it touches the front panel. Then continue turning until the angle bracket is pulled approximately  $1/32$ " away from the metal washer on the wood strip.

This completes the wiring of the kit. Check to see that all connections are soldered and that no solder bridges exist between foils on the circuit board. Check to see that the transistor and electrolytic capacitor were installed properly, as these parts can be damaged if installed incorrectly.



## TEST AND CALIBRATION

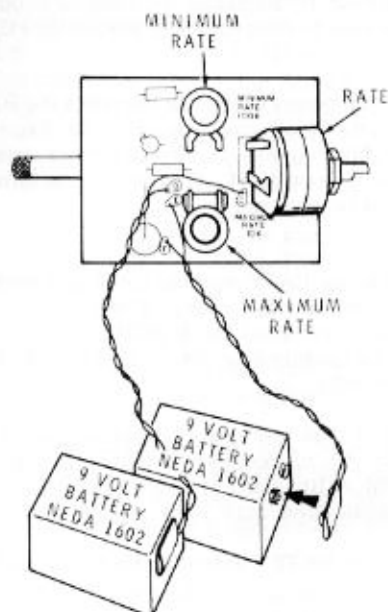

Figure 1

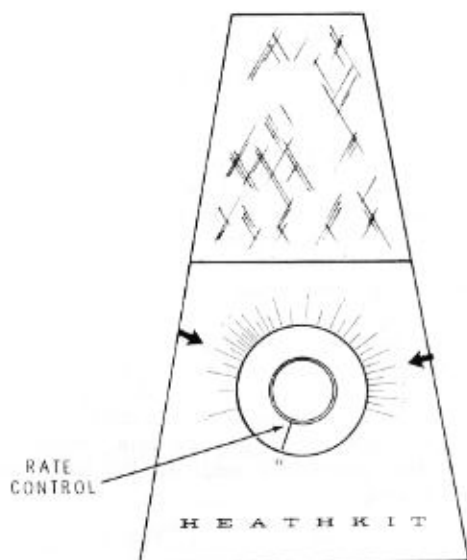

Figure 2

Refer to Figures 1 and 2 for the following steps.

- ( ) Install the knob on the shaft of the RATE control and turn the RATE control to the OFF position.
- ( ) Using a small screwdriver, turn the MINIMUM RATE and MAXIMUM RATE controls fully counterclockwise.
- ( ) Turn the MINIMUM RATE control 1/2 of its rotation clockwise.
- ( ) Turn the MAXIMUM RATE control 1/2 of its rotation clockwise.

NOTE: If the Metronome does not seem to function properly when you make the following adjustments, turn the unit off and refer to the In Case Of Difficulty section of the Manual.

- ( ) Connect a 9 volt NEDA type 1602 battery to each battery connector.

- ( ) Turn the RATE control clockwise until its pointer is at 60 on the front panel. A repetitive click should now be heard from the Metronome. If you do not hear the clicks, increase the setting of the RATE control until the clicking is heard. Then return the control to the 60 marking on the front panel.

NOTE: It may be necessary to change the setting of the threaded thumbscrew on the rear of the Metronome to obtain a loud enough click to perform the calibration.

- ( ) Make an initial count of the clicks for 15 seconds, using a sweep-second hand of a clock or watch.
- ( ) Now adjust the MINIMUM RATE control until you get as close to 60 clicks per minute as possible. Turn the control counterclockwise to increase the rate, or clockwise to decrease the rate of the clicks. Checking the clicks over a one or two-minute period will give a more accurate calibration.

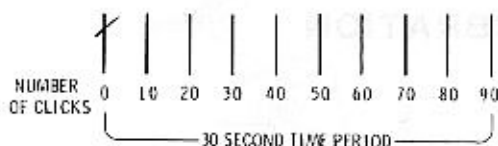

Figure 3

NOTE: The MAXIMUM RATE control will be adjusted next at 180 clicks per minute and, because the clicks are difficult to count, at this rapid rate, Figure 3 is included to help you. The timing period in Figure 3 is for 30 seconds, which will be 90 clicks. Counting from one to ten is easier than counting to 90 at such a rapid rate. Therefore, each time you reach 10 while counting, you should make a small mark (like the one on the 0 line) across the vertical line marked 10 in the Figure. Then count from one to ten again and cross out the line marked 20. Repeat this procedure until all the lines have been marked.

- ( ) Set the RATE control to 180 on the front panel.
- ( ) Make an initial count to check the number of clicks for a 30 second period.

- ( ) Now adjust the MAXIMUM RATE control until you get exactly 90 clicks for a 30 second timing period. Turn this control clockwise to increase the rate or counterclockwise to decrease the rate of the clicks.

NOTE: It will be very difficult to return the RATE control to the same exact position used to calibrate the Metronome at 60 clicks per minute. If the timing is only off a few clicks, recalibration will not be necessary.

- ( ) Return the RATE control to 60 and recheck the number of clicks. If the timing has changed, readjust the MINIMUM RATE control as required to obtain exactly 60 clicks per minute.

NOTE: If it was necessary to change the calibration at 60 clicks per minute, you should recheck the calibration at 180 clicks per minute as the calibration may have changed slightly.

- ( ) Turn the RATE control to its OFF position.

This completes the Test And Calibration of the Metronome.

## FINAL ASSEMBLY

Refer to Pictorial 3 (fold-out from Page 11) for the following steps.

NOTE: The blue and white label that is installed in the next step shows the Model number and Production Series number of your kit. Use these numbers in any communications with the Heath Company; this assures you that you will receive the most up-to-date information in return.

- ( ) Carefully peel away the backing paper from the blue and white label. Then press the label onto the inside of the front panel. See inset drawing #1 on Pictorial 3.
- ( ) Temporarily remove the 6-32 threaded thumbscrew from the Metronome.
- ( ) Refer to Detail 3A and cut a cardboard spacer from the shipping carton using the dimensions on the Detail. Be sure the corrugations are positioned as shown.
- ( ) Position the batteries on the front panel with the battery connectors and their wires positioned as shown.
- ( ) Now install the cardboard spacer by bending it around the batteries as shown in Pictorial 3. Compress the cardboard so it will fit between the control and batteries.
- ( ) Now slide the front panel into the groove of the cabinet. Keep the batteries positioned as shown. Slide the front panel in until its bottom edge is flush with the bottom edge of the cabinet.
- ( ) Position the bottom plate on the cabinet with one edge even with the back of the cabinet as shown in the inset drawing #2 on the Pictorial and mark the position of the four mounting holes on the bottom edge of the cabinet.

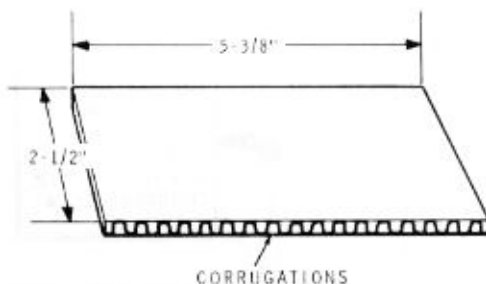

Detail 3A

- ( ) Make a screw-starter hole (1/16" deep, dent in the wood) at each of these four marked locations with a pointed object (such as a small nail). Be very careful not to split the cabinet.
- ( ) Mount the bottom plate on the cabinet with four #2 x 3/16" screws. Do not overtighten the screws.
- ( ) Carefully peel away the backing paper from the instruction label. Then press the label onto the bottom plate. Center the label carefully between the screws and position the top of the label towards the front of the cabinet.
- ( ) Peel off the protective backing from the felt feet and press the feet onto the bottom plate as shown. Do not position the feet over any printing on the label.
- ( ) Replace the 6-32 threaded thumbscrew by inserting it into the hole in the back of the cabinet.
- ( ) Turn the Metronome on and set the thumbscrew for the desired loudness. Then, turn the Metronome off.

This completes the assembly of the Metronome. Proceed to the Operation section of the Manual.

## OPERATION

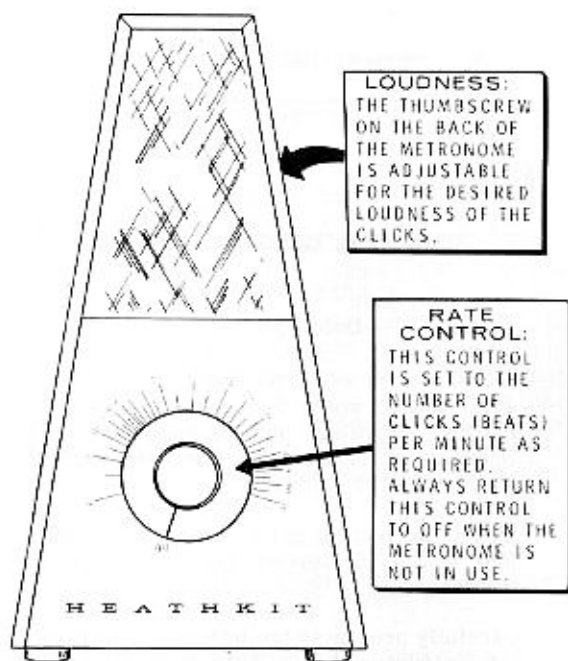

Figure 4

Once the Metronome is calibrated, only two adjustments need to be made during its use. See Figure 4 for the instructions on these two adjustments.

When the speed in beats per minute is given on the music sheet, set the RATE control to this number. If the beats per minute are not indicated on the music, find the proper setting for the RATE control on the label on the bottom of the Metronome.

As an example of how the label is used, you could find the beats per minute for a musical score with a 2/4 time signature and an allegro tempo as follows:

1. Find the note to receive one beat (♩) under the tempo (allegro) in the chart at the top of the label. The chart shows (♩ = 84-144). These numbers indicate the Metronome beat per minute range suitable for this musical score.
2. Set the RATE control to a number between 84 and 144 on the front panel of the Metronome. Place the control near the lower number of the range for a tranquil mood, or set it near the high end of the range for an animated mood.

This completes the Operation section of the Manual.

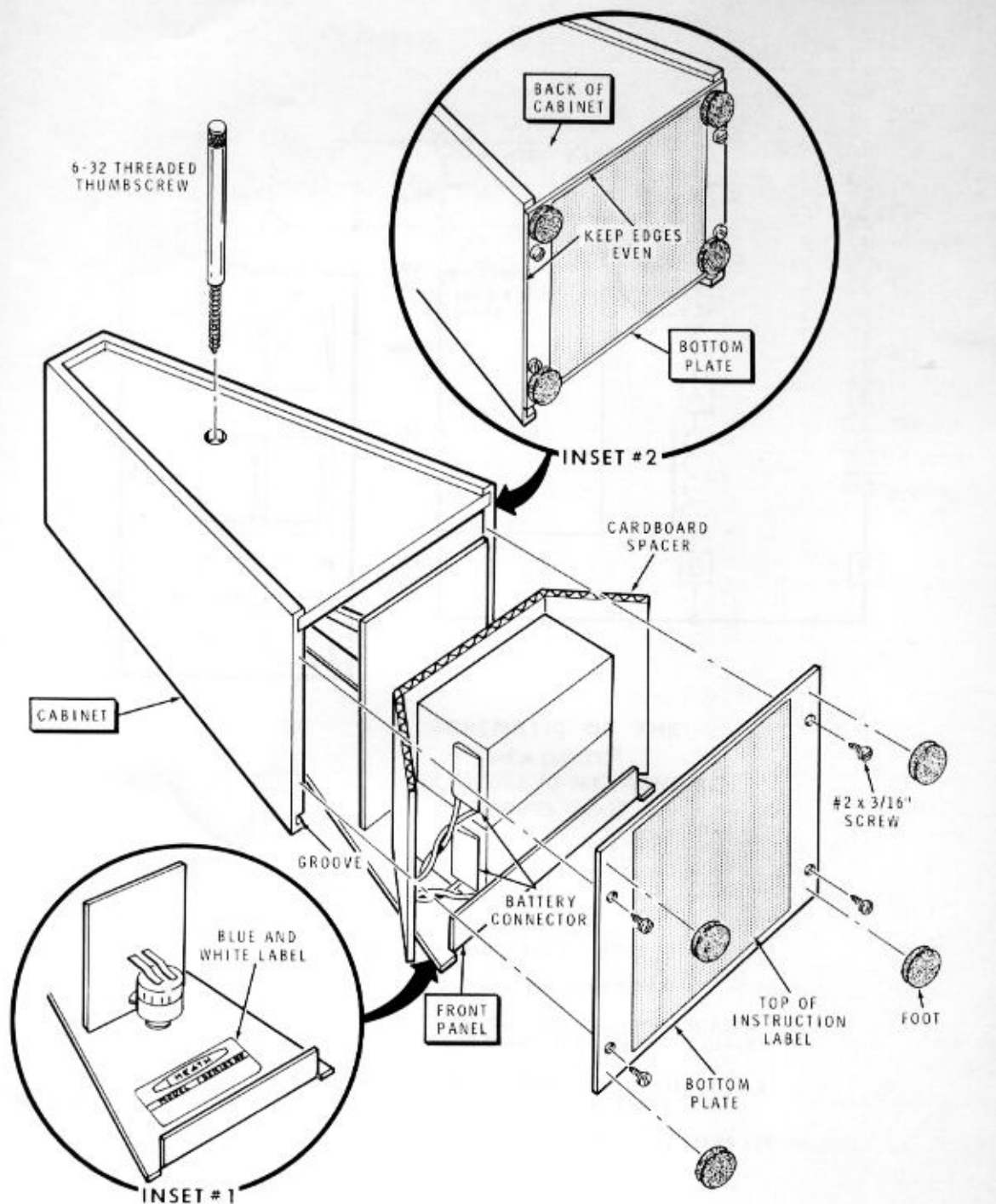

**PICTORIAL 3**

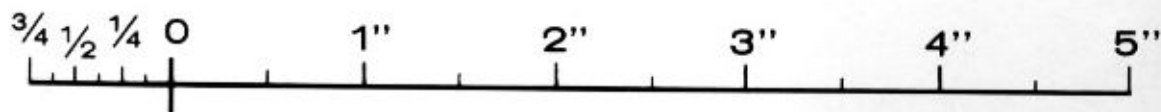

## IN CASE OF DIFFICULTY

The following paragraphs deal with the types of difficulties that may be encountered right after the kit is assembled. These difficulties are most likely to be caused by assembly errors or faulty soldering. These checks will help you locate any error of this type that might have been made. NOTE: Refer to the Kit Builders Guide for Service and Warranty information.

1. Recheck the wiring. It is frequently helpful to have a friend check your work. Someone who is not familiar with the unit may notice something consistently overlooked by the builder.
2. About 90% of the kits that are returned for repair do not function properly due to poor connections and soldering. Therefore many troubles can be eliminated by reheating all connections to make sure that they are soldered as described in the Soldering section of the Kit Builders Guide.
3. Check the values of all the parts. Be sure that the proper part has been installed at each location on the circuit board.
4. Check for bits of solder, wire ends, or other foreign matter which may be lodged in the wiring.
5. Check very carefully to be sure there are no solder bridges between circuit board foils. To remove a solder bridge from between foils, hold the circuit board with the foil side down and, with a clean soldering iron melt the excess solder from the foils.
6. Be sure the transistor and electrolytic capacitor leads are installed in their proper holes.
7. Recheck the mechanical assembly. Since the sounder is an electromechanical device, the difficulty can be mechanical as well as electrical.
8. A review of the Circuit Description and Schematic may also help you to locate any difficulties in the kit. Refer to the Circuit Board X-Ray View for help in locating parts.

NOTE: In an extreme case where you are unable to resolve a difficulty, refer to the Service and Warranty sections of the "Kit Builders Guide", and to the "Factory Repair Service" information on Page 12 of this Manual.

### Troubleshooting Chart

CONDITION	POSSIBLE CAUSE
1. Metronome completely inoperative.	A. Dead batteries. B. Broken battery or coil (L1) lead. C. Improperly installed or faulty transistor. D. Defective switch on control R1. E. Open resistor R4 or R5. F. Defective control R3. G. Shorted coil L1. H. Shorted capacitor C1.
2. Weak output.	A. Weak batteries. B. Bent, loose, or misaligned coil mounting bracket. C. End of threaded stud of coil L1 not even with end of angle bracket.
3. Fails to align on scale properly, but beats with loud volume.	A. See Test And Calibrate section of Manual. B. Open or wrong value resistor R4 or R5. C. Defective control R1, R2, or R3. D. Controls R2 and R3 interchanged. E. Defective capacitor C1.



## SPECIFICATIONS

Range. . . . .	Continuously variable from 40 to 210 beats per minute; calibrated in 5 beats per minute intervals.
Battery Requirements. . . . .	18 volts: two long-life 9 volt batteries (NEDA 1602).
Battery Life. . . . .	Approximately 300 hours.
Cabinet. . . . .	Cherry-finished birch solids and veneers.
Overall Dimensions. . . . .	6-3/4" high x 3-3/4" wide x 4" deep.
Net Weight. . . . .(less batteries), . . . . .	11 oz.

The Heath Company reserves the right to discontinue instruments and to change specifications at any time without incurring any obligation to incorporate features into instruments previously sold.

## FACTORY REPAIR SERVICE

You can return your completed kit to the Heath Company Service Department to have it repaired for a minimum service fee. (Kits that have been modified will not be accepted for repair.) If you wish, you can deliver your kit to a nearby Heath Authorized Service Center. These centers are listed in your Heathkit catalog.

To be eligible for replacement parts under the terms of the warranty, equipment returned for factory repair service, or delivered to a Heath Authorized Service Center, must be accompanied by the invoice or the sales slip, or a copy of either. If you send the original invoice or sales slip, it will be returned to you.

If it is not convenient to deliver your kit to a Heath Authorized Service Center, please ship it to the factory at Benton Harbor, Michigan and follow the following shipping instructions:

Prepare a letter in duplicate, containing the following information:

- Your name and return address.
- Date of purchase.
- A brief description of the difficulty.
- The invoice or sales slip, or a copy of either.
- Your authorization to ship the repaired unit back to you C.O.D. for the service and shipping charges, plus the cost of parts not covered by the warranty.

Attach the envelope containing one copy of this letter directly to the unit before packaging, so that we do not overlook this important information. Send the second copy of the letter by separate mail to Heath Company, Attention: Service Department, Benton Harbor, Michigan.

Check the equipment to see that all parts and screws are in place. (Do not include wooden cabinets when shipping receivers, tuners, amplifiers, or TV sets, as these are easily damaged in shipment.) Then, wrap the equipment in heavy paper. Place the equipment in a strong carton, and put at least THREE INCHES of resilient packing material (shredded paper, excelsior, etc.) on all sides, between the equipment and the carton. Seal the carton with gummed paper tape, and tie it with a strong cord. Ship it by prepaid express, United Parcel Service, or insured parcel post to:

Heath Company  
Service Department  
Benton Harbor, Michigan 49022

## CIRCUIT DESCRIPTION

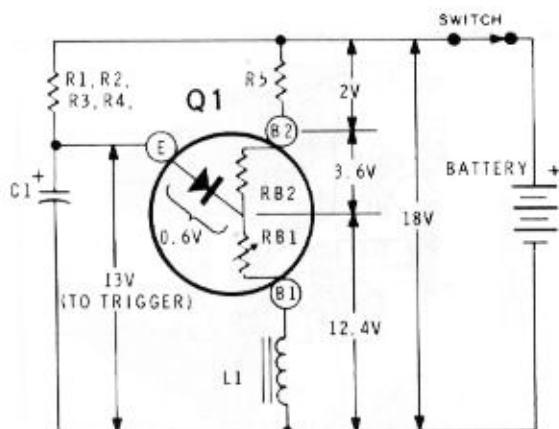

Figure 5

Refer to the Schematic Diagram (fold-out from Page 15) and to the equivalent circuit in Figure 5 while reading this Circuit Description.

Unijunction transistor Q1 is a semiconductor device which has two base connections and one emitter junction (unijunction). When the switch on control R1 is first closed, the emitter of Q1 is reverse biased (emitter voltage is less than 13 volts) and no emitter current flows. With no emitter current flow and the positive voltage present at B2 of the transistor, the interbase resistance (RB2 plus RB1) is high (between five and ten thousand ohms) and only a small "idle" current flows from B2 to B1. This idle current flow results in a voltage drop of about 2 volts across resistor R5, a voltage drop across RB2 of approximately 3.6 volts: the remaining 12.4 volts is dropped across RB1 and coil L1.

When the switch is closed, current flows and starts charging capacitor C1 through controls R1, R2, R3, and resistor R4. The rate at which C1 charges is determined by the combined

resistance of R1 through R4. As C1 charges, the voltage across it increases. This same voltage is applied to the emitter of Q1. When this voltage reaches 13 volts, the emitter diode conducts and the resistance of RB1 rapidly changes to a very low value. The triggering voltage (13 volts) is the sum of the voltage drops across the emitter diode (0.6 volt) and L1 (12.4 volts).

When the emitter diode conducts, capacitor C1 discharges through emitter-base junction B1 and L1. This discharge current in L1 creates a magnetic force in its poles (threaded stud and angle bracket). This discharge current through L1 is many times greater than the idle current through R5, RB2, and RB1. When the thumbscrew is adjusted properly, the steel washer adjacent to L1 is attracted by the magnetic force to the poles of L1. This force is great enough to overcome the spring action of the wood sounding strip, and the result is a clicking sound when the steel washer hits the poles of L1. The wood sounding strip projects the click through the grille and into the room.

When capacitor C1 discharges to approximately 2 volts, the emitter diode becomes reverse biased and stops conducting. With reverse bias on the emitter, resistor RB1 returns to its original high value, sharply reducing the current flow through L1. This reduces the magnetism of the poles of L1, and the steel washer is allowed to separate from L1.

This entire cycle repeats itself at a rate governed by the setting of control R1. Controls R2 and R3 are used to adjust the minimum and maximum resistance limits of control R1 so that the beat rate corresponds to the dial setting.

The thumbscrew at the rear of the Metronome adjusts the gap between the steel washer and the poles of L1 to determine the loudness of the clicks.



## CIRCUIT BOARD X-RAY VIEWS

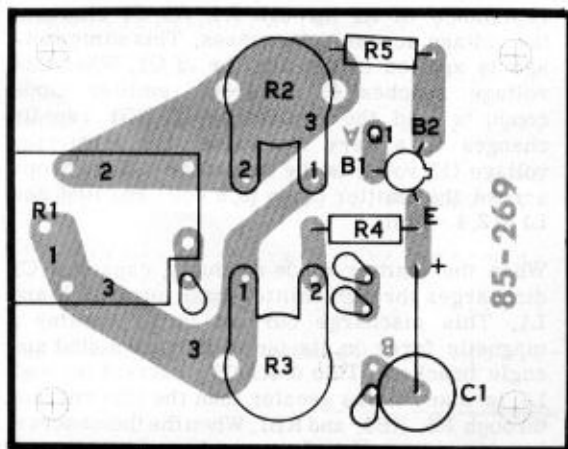

**CIRCUIT BOARD**  
(VIEWED FROM FOIL SIDE)

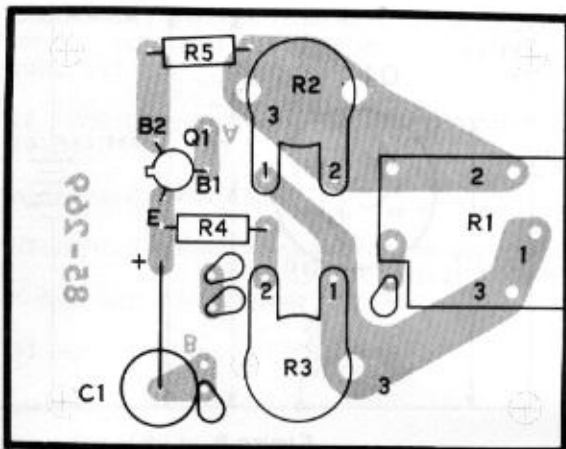

**CIRCUIT BOARD**  
(VIEWED FROM COMPONENT SIDE)

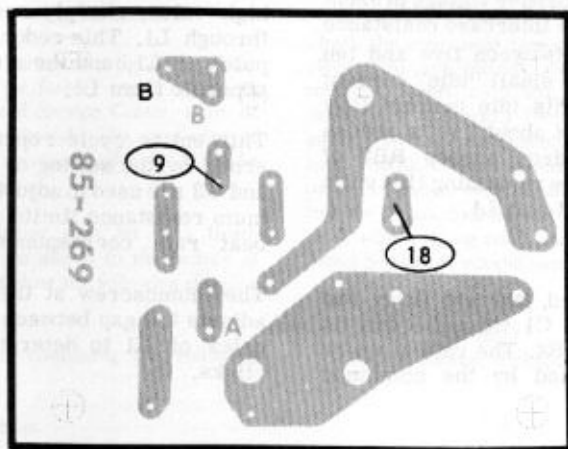

**VOLTAGES**  
(VIEWED FROM FOIL SIDE)

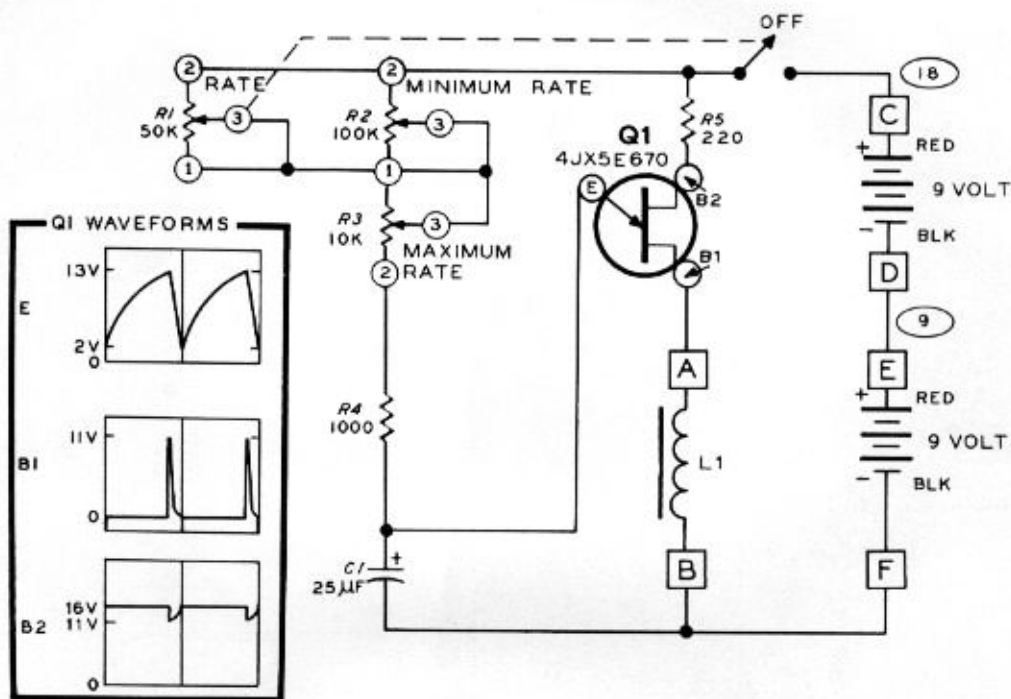

**SCHEMATIC OF THE  
HEATHKIT®  
SOLID-STATE METRONOME  
MODEL TD-17**

**NOTES:**

1. ALL RESISTORS ARE 1/2 WATT. RESISTOR VALUES ARE IN OHMS.
2. ○ THIS SYMBOL INDICATES A POSITIVE DC VOLTAGE.
3. ALL VOLTAGES ARE MEASURED FROM THE POINT INDICATED TO POINT **F** OR **B** ON THE CIRCUIT BOARD.
4. □ THIS SYMBOL INDICATES AN EXTERNAL CONNECTION TO THE CIRCUIT BOARD.
5. REFER TO THE CIRCUIT BOARD X-RAY VIEWS FOR THE PHYSICAL LOCATION OF PARTS.

## REPLACEMENT PARTS PRICE LIST

PART No.	PRICE Each	DESCRIPTION	PART No.	PRICE Each	DESCRIPTION
<b>GENERAL</b>			<b>#6 Hardware</b>		
1-45	.10	220 1/2 watt resistor	250-56	.05	6-32 x 1/4" screw
1-9	.10	1000 $\Omega$ 1/2 watt resistor	250-276	.05	6-32 x 3/8" black screw
10-201	.40	10 k $\Omega$ control	250-394	.20	6-32 threaded thumbscrew
10-244	.55	100 k $\Omega$ control	253-21	.05	#6 flat washer
19-125	1.05	50 k $\Omega$ control with SPST switch	254-1	.05	#6 internal tooth lockwasher
25-145	.25	25 $\mu$ F electrolytic capacitor	254-6	.05	#6 external tooth lockwasher
40-851	.50	Coil	255-94	.10	6-32 tapped spacer
91-188	4.20	Cabinet	<b>Other Hardware</b>		
209-59	.55	Plastic grille	250-355	.05	#2 x 3/16" screw
263-7	.05	Felt foot	252-7	.05	Control nut
417-96	2.25	4JX5E670 transistor	253-10	.05	Control flat washer
432-33	.25	Battery connector	254-4	.05	Control lockwasher
462-287	.60	Knob	The above prices apply only on purchases from the Heath Company where shipment is to a U.S.A. destination. Add 10% (minimum 25 cents) to the price when ordering from an authorized Service Center or Heathkit Electronic Center to cover local sales tax, postage and handling. Outside the U.S.A. parts and service are available from your local Heathkit source and will reflect additional transportation, taxes, duties and rates of exchange.		
85-269-2	.60	Circuit board	To order parts, use the Parts Order Form furnished with this kit. If a Parts Order Form is not available, refer to "Replacement Parts" in the "Kit Builders Guide."		
390-283	.15	Instruction label			
	2.00	Manual (See front cover for part number,)			
331-6	.15	Solder			
<b>METAL PARTS</b>					
100-730	.50	Front panel			
100-732	.20	Coil mounting bracket			
204-102	.10	Angle bracket			
205-730	.25	Bottom plate			
<b>HARDWARE</b>					
<b>#5 Hardware</b>					
250-120	.05	5-40 x 7/8" threaded stud			
252-40	.05	5-40 nut			

## CIRCUIT BOARD X-RAY VIEWS

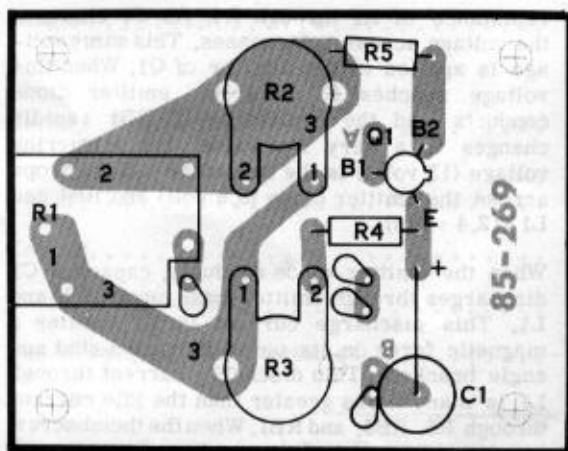

**CIRCUIT BOARD**  
(VIEWED FROM FOIL SIDE)

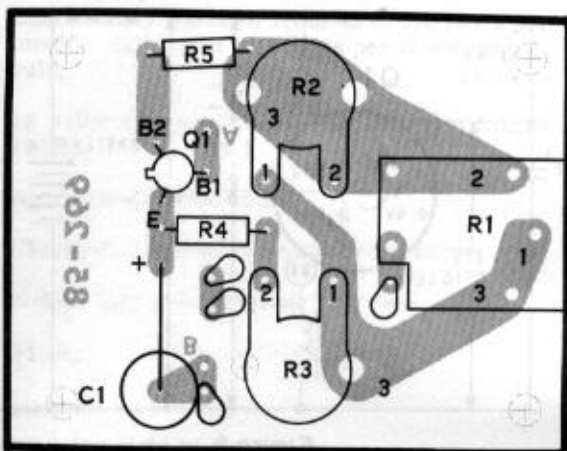

**CIRCUIT BOARD**  
(VIEWED FROM COMPONENT SIDE)

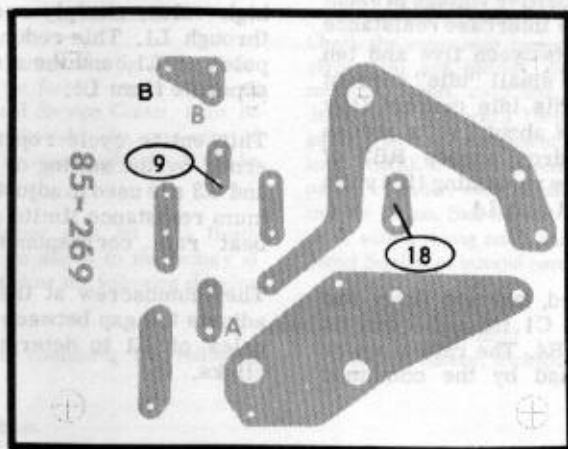

**VOLTAGES**  
(VIEWED FROM FOIL SIDE)