

PRICE \$1.00



**Assembling
and Using Your...**

Heathkit

**SIGNAL
GENERATOR**

MODEL SG-8

HEATH COMPANY

A Subsidiary of Daystrom Inc.

BENTON HARBOR, MICHIGAN

STANDARD COLOR CODE — RESISTORS AND CAPACITORS

AXIAL LEAD RESISTOR

INSULATED UNINSULATED Color	FIRST RING BODY COLOR First Figure	SECOND RING END COLOR Second Figure	THIRD RING DOT COLOR Multiplier
BLACK	0	0	None
BROWN	1	1	0
RED	2	2	.00
ORANGE	3	3	.000
YELLOW	4	4	0.000
GREEN	5	5	00.000
BLUE	6	6	000.000
VIOLET	7	7	0,000.000
GRAY	8	8	00,000.000
WHITE	9	9	000,000.000

DISC CERAMIC RMA CODE

RADIAL LEAD DOT RESISTOR

5-DOT RADIAL LEAD CERAMIC CAPACITOR

EXTENDED RANGE TC CERAMIC HICAP

RADIAL LEAD (BAND) RESISTOR

BY-PASS COUPLING CERAMIC CAPACITOR

AXIAL LEAD CERAMIC CAPACITOR

The standard color code provides all necessary information required to properly identify color coded resistors and capacitors. Refer to the color code for numerical values and the zeroes or multipliers assigned to the colors used. A fourth color band on resistors determines tolerance rating as follows: Gold = 5%, silver = 10%. Absence of the fourth band indicates a 20% tolerance rating.

The physical size of carbon resistors is determined by their wattage rating. Carbon resistors most commonly used in Heathkits are 1/2 watt. Higher wattage rated resistors when specified are progressively larger in physical size. Small wire wound resistors 1/2 watt, 1 or 2 watt may be color coded but the first band will be double width.

MOLDED MICA TYPE CAPACITORS

CURRENT STANDARD CODE

JAN & 1948 RMA CODE

RMA 3-DOT (OBSOLETE) RATED 500 W.V.D.C. ± 20% TOL.

BUTTON SILVER MICA CAPACITOR

RMA (5-DOT OBSOLETE CODE)

RMA 6-DOT (OBSOLETE)

RMA 4-DOT (OBSOLETE)

MOLDED PAPER TYPE CAPACITORS

TUBULAR CAPACITOR

Normally stamped for value

A 2 digit voltage rating indicates more than 900 V. Add 2 zeros to end of 2 digit number.

MOLDED FLAT CAPACITOR Commercial Code

JAN. CODE CAPACITOR

The tolerance rating of capacitors is determined by the color code. For example: red = 2%, green = 5%, etc. The voltage rating of capacitors is obtained by multiplying the color value by 100. For example: orange = 3 × 100 or 300 volts. Blue = 6 × 100 or 600 volts.

In the design of Heathkits, the temperature coefficient of ceramic or mica capacitors is not generally a critical factor and therefore Heathkit manuals avoid reference to temperature coefficient specifications.

ASSEMBLY AND OPERATION OF THE HEATHKIT SIGNAL GENERATOR MODEL SG-8



SPECIFICATIONS

Frequency Range

Band A.....	160 kc to 500 kc
Band B.....	500 kc to 1650 kc
Band C.....	1.65 mc to 6.5 mc
Band D.....	6.5 mc to 25 mc
Band E.....	25 mc to 110 mc

Calibrated Harmonics.....110 mc to 220 mc

Radio Frequency Output.....In excess of 100,000 microvolts

Modulation Frequency.....Approximately 400 cycles

Audio Output.....2 to 3 volts

Audio Frequency Input.....Approximately 5 v across 1 megohm

Tubes

12AU7.....RF Oscillator-Buffer

6C4.....Audio Oscillator or Audio Amplifier

Power Requirements.....105-125 v, 50/60 cycles

Cabinet Size.....9 1/2 wide x 6 1/2 high x 5 deep

Shipping Weight......7 lbs.

INTRODUCTION

The Heathkit model SG-8 Signal Generator has been designed for simplicity of construction and stability of operation. A little care taken during the process of construction will reward the kit builder with a signal generator which will give excellent performance and will be both pleasant and easy to use. This generator has been engineered so that it will be valuable to the radio repairman, ham and experimenter over a wide range of uses, in addition to being a rugged and highly dependable piece of test equipment. It is made with high quality parts, conservatively rated, and will give long and efficient service. The model SG-8 Signal Generator utilizes factory adjusted coils, thereby eliminating the necessity of having costly equipment available to calibrate the finished kit.

CIRCUIT DESCRIPTION

The RF portion of the SG-8 Signal Generator consists of a 12AU7 twin triode tube. One triode section of this tube is used as a Colpitts oscillator. The other triode section is used in a cathode follower type circuit and acts as a buffer between the oscillator and the output of the signal generator. Four inductances wound on forms comprise the coils for bands A, B, C and D. They are switched into the circuit by means of the band switch. The E band coil is unique in its construction insofar that the heavy buswire of which it is composed actually forms the connections between the band switch and the tuning condenser for all of the lower frequency coils. When the band switch is placed in E band position, a short is placed across the leads of the E band coils, thereby making it a closed circuit inductance which is capable of tuning from 25 to 100 megacycles.

In a Colpitts oscillator circuit, feedback necessary to maintain oscillations is obtained from a capacitive reactance divider across the inductance of the frequency determining circuit. In the model SG-8, a capacitive divider is obtained by the use of a split-stator condenser. The advantage of this will be made apparent from the following explanation. For example, take a capacitive divider composed of fixed capacities. As the frequency across the condensers is increased, the reactance of the condensers is decreased. Therefore, using a fixed capacitive divider, as the frequency is increased reactance would become lower until a point was reached where oscillations could no longer be maintained. By the use of a split-stator condenser for both tuning and as the divider network as the frequency is increased, the capacity of the condenser dividing network is decreased. The reactance of a condenser for any given frequency is inversely proportional to the capacity. This tends to maintain the reactance of the network fairly constant, thereby permitting oscillation over a wide range of frequency.

The use of the cathode follower as a buffer stage has the following advantage: The characteristics of a "cathode follower" are very low output impedance with an extremely high input impedance. The extremely high input impedance produces little or no loading on the oscillator circuit. The very low output impedance provides a very stable output from the signal generator. The effect is such that a varying load on the output of the signal generator will produce little or no frequency instability of the oscillator. The signal generator incorporates a step attenuator for coarse control of radio frequency output and a continuously variable attenuation circuit for fine control of the radio frequency output.

The audio oscillator is also a Colpitts circuit. By the use of the large inductance of an iron-core choke and relatively high capacity in the capacitive divider, it is made to oscillate at approximately 400 cycles. This type of oscillator was again chosen for its stability and purity of waveform. With the modulation switch in the INT. position, 400 cycles audio voltage is applied through a resistance network to the grid of the cathode follower stage. This audio voltage is impressed as an amplitude modulated signal upon the RF output from the cathode follower.

At the same time the audio voltage is also applied to the external audio connector marked OUT, and may be used as an audio signal source for testing amplifiers, etc. With the modulation switch in the EXT. position, any external audio source of any frequency may be used to modulate the RF output of the signal generator. The 6C4 audio oscillator tube then becomes an amplifier stage for the external signal.

The power supply consists of a transformer which furnishes filament voltage to the 6C4 and 12AU7 tubes, and effectively isolates the instrument from the AC line. A selenium rectifier is connected to one winding of the transformer producing half-wave rectification. An RC filter network changes the pulsed output from the rectifier to fairly pure DC. The 110 volt input has both sides bypassed to minimize the signal feeding back through the power lines.

A unique design feature is the convenient AF IN-OUT control, which adjusts audio input if external modulation is employed and likewise adjusts the AF output level when using the generator as a source of audio output.

PRELIMINARY INSTRUCTIONS AND NOTES

The Heathkit model SG-8 Signal Generator when constructed in accordance with the instructions in this manual, is a high-quality piece of test equipment, capable of years of trouble-free service. We therefore urge you to take the necessary time to assemble and wire the kit carefully. You will be rewarded with a neat appearing, well-built and dependable test oscillator.

This manual is supplied to assist you in every way to complete the signal generator with the least possible chance for error. We suggest that you take a few minutes now and read the entire manual through before any work is begun. This will enable you to proceed with the work much faster when construction is started. The large, fold-in pictorials are handy to attach to the wall above your work space. Their use will greatly simplify the construction of the kit. These diagrams are repeated in smaller form within the manual. We suggest that you retain the manual in your files for future reference, both in the use of the signal generator and for its maintenance.

UNPACK THE KIT CAREFULLY AND CHECK EACH PART AGAINST THE PARTS LIST. In so doing, you will become acquainted with each part. Refer to the charts and other information shown on the inside covers of the manual to help you identify any parts about which there may be a question. If some shortage is found in checking the parts, please notify us promptly and return the inspection slip with your letter to us. Hardware items are counted by weight, and if a few are missing, please obtain them locally if at all possible.

Read the note on soldering on the inside of the backcover. Crimp all leads tightly to the terminal before soldering. Be sure both the lead and the terminal are free of wax, corrosion, or other foreign substances. Use only the best rosin core solder, preferably a type containing the new activated fluxes, such as Kester "Resin-Five," Ersin "Multicore," or similar types.

NOTE: ALL GUARANTEES ARE VOIDED AND WE WILL NOT REPAIR OR SERVICE INSTRUMENTS IN WHICH ACID CORE SOLDER OR PASTE FLUXES HAVE BEEN USED. WHEN IN DOUBT ABOUT SOLDER, IT IS RECOMMENDED THAT A NEW ROLL PLAINLY MARKED "ROsin CORE RADIO SOLDER" BE PURCHASED.

Resistors and condensers generally have a tolerance rating of $\pm 20\%$ unless otherwise stated in the parts list. Therefore a 100 K Ω resistor may test anywhere from 80 K Ω to 120 K Ω . (The letter K is commonly used to designate a multiplier of 1000.) Tolerances on condensers are generally even greater. Limits of +100% and -50% are common for electrolytic condensers. The parts furnished with your Heathkit have been specified so they may not adversely affect the operation of the finished signal generator.

In order to expedite delivery to you, we are occasionally forced to make minor substitutions of parts. Such substitutions are carefully checked before they are approved, and the parts supplied will work satisfactorily. By checking the parts list for resistors, for example, you may find that a 2.2 megohm resistor has been supplied in place of a 2 megohm as shown in the parts list. These changes are self-evident and are mentioned here only to prevent confusion in checking the contents of your kit.

We strongly urge that you follow the wiring and parts layout shown in the manual. The position

of wires and parts is extremely critical in circuits operating at high frequencies, and changes may seriously affect the characteristics or calibration of the signal generator.

STEP-BY-STEP ASSEMBLY INSTRUCTIONS

The following instructions are presented in a simple, logical, step-by-step sequence to enable you to complete your kit with the least possible confusion.

Be sure to read each step all the way through before starting. When a step is completed, check it off in the space provided. This makes it easy to resume construction after your work has been interrupted.

Leads on condensers, transformers, and resistors are generally much longer than they need be to make the indicated connections. In these cases, the excess leads should be cut off as the parts are added to the chassis. Not only does this make the wiring much neater but in radio frequency work, the excess length of leads may actually create tuned parasitic circuits at undesired frequencies.

NOTE: We suggest that you execute the following preparations before any work is started:

1. Select from the large fold-in pictorials included with the manual the diagram showing the phase of construction you are engaged in at the time. Attach this diagram to the wall above your work space.
2. After identifying the parts from the parts list, lay them out in a large shallow box so that they are readily accessible. This will save considerable time in construction.
3. Read thoroughly the assembly and wiring instructions on the inside rear cover of the manual and refer to the general information on both inside covers of the manual to identify the parts.

NOTE: In assembling the kit, use lockwashers under all nuts unless a solder lug is used. The 3-48 screws and nuts used in mounting the miniature tube sockets are the only exception to this rule.

Unless otherwise stated, 6-32 screws, lockwashers and nuts are used in mounting of parts. Wire is to be insulated unless otherwise specified. Insulated sleeving is to be used on bare wires when called for.

ASSEMBLY OF SUB-CHASSIS

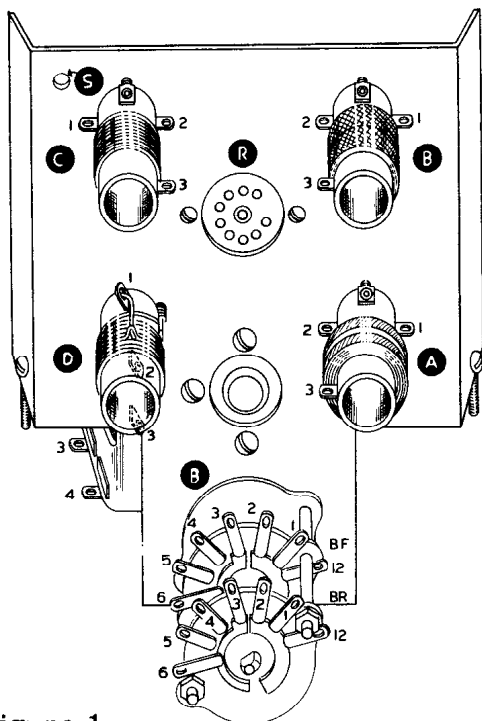

Figure 1

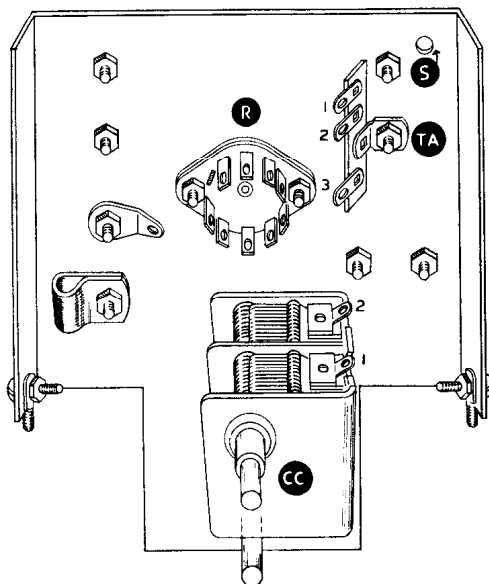
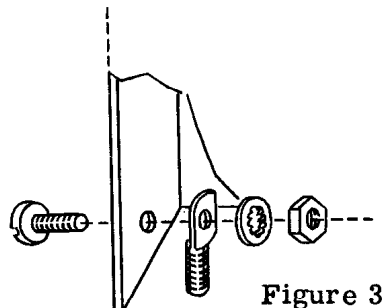

Figure 2

- () Mount two 6-32 spade bolts on the sub-chassis aprons as shown in Figure 2. Method of mounting is shown in Figure 3.
- () Mount a 9-pin miniature socket R on the sub-chassis, using 3-48 screws and nuts. Position as shown in Figures 1 and 2.



- () Mount the tuning condenser as shown in Figures 1 and 2, using 3/16 6-32 screws with lockwashers under the heads.
- () Mount the band switch B, using a control lockwasher and control nut. Omit the flat washer. Position as shown in Figure 2. See Figure 5 for method of mounting controls.

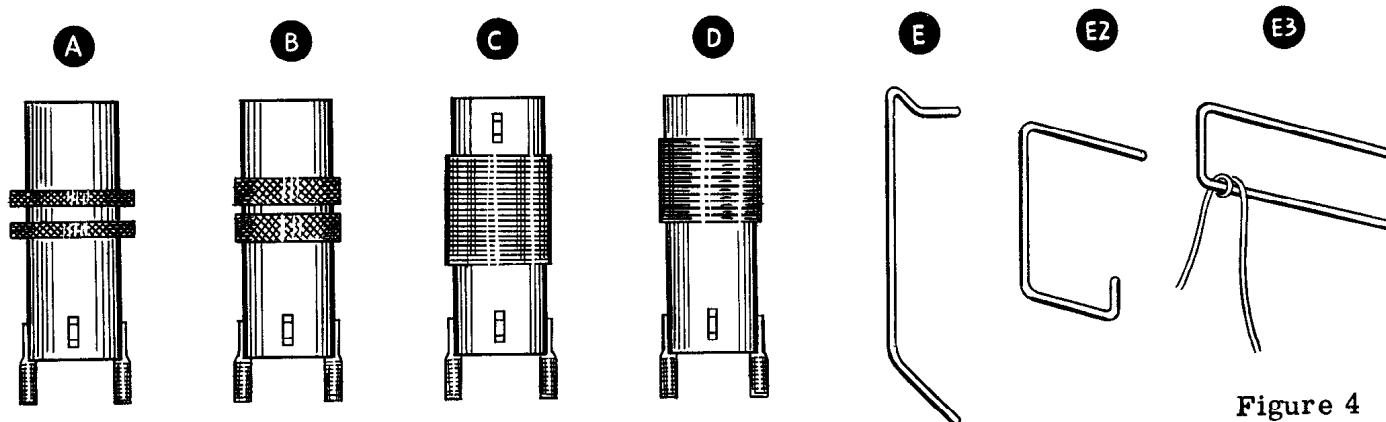

Figure 4

- () Referring to Figure 4 for coil identification, and Figure 1 for coil position, mount the coils A, B, C and D. Referring to Figure 2, note that coil C has a 3-lug terminal strip mounted on its lower mounting screw, and coil A has a solder lug on its upper mounting screw. Use lockwashers on all coil mounting screws except the one having the solder lug.

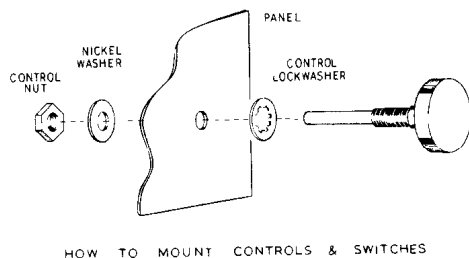
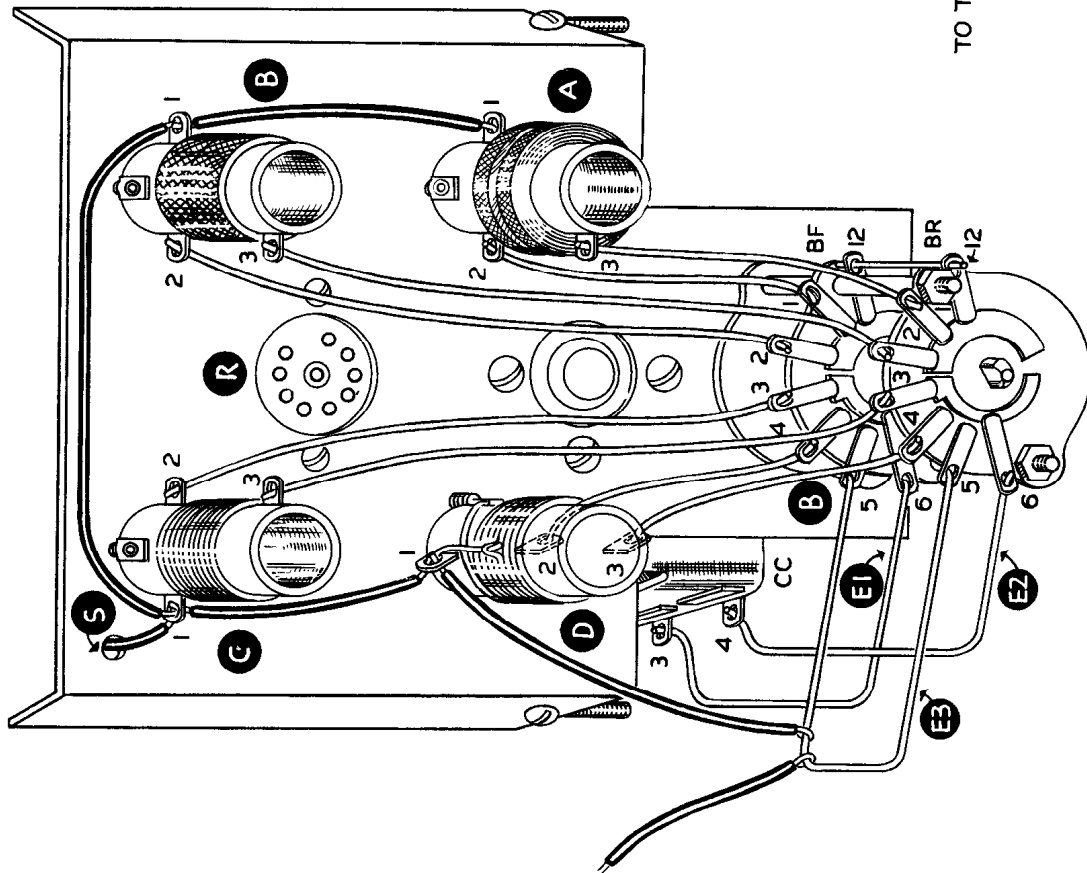

Figure 5

WIRING THE SUB-CHASSIS

NOTE: Before beginning the wiring, refer again to the notes on wiring and soldering on the inside rear cover of the manual. We cannot stress too strongly the importance of careful wiring and soldering when applied to radio frequency circuits. In building this signal generator you will use a considerable amount of bare wire. Care should be taken to avoid possible shorts to the chassis or other components. The leads should be kept short and straight when possible. Soldering should be done with a great deal of care, so that fluxes will not run over onto adjacent insulation, thus causing leakage and a possible source of trouble.

Components are given code designations so that the identification of parts on both the diagrams and on written matter is easily defined. The switch terminals are numbered in such a manner that if the switch were viewed from the front, the numbering system would progress in a clockwise direction around the switch. The band switch sections are referred to as BF or BR, corresponding to the front and rear sections of the switch when viewed from the shaft end. The tube sockets are also numbered in a clockwise direction, as viewed from the bottom, starting from the gap between the socket terminals. Thus a reference to R4 refers to the number 4 terminal on socket R, counted from the first terminal to the left of the open space between terminals 1 and 9 on that particular socket. In wiring the sub-chassis, reference to Pictorials 1 and 2 will illustrate the placement of all parts and leads.



PICTORIAL 1

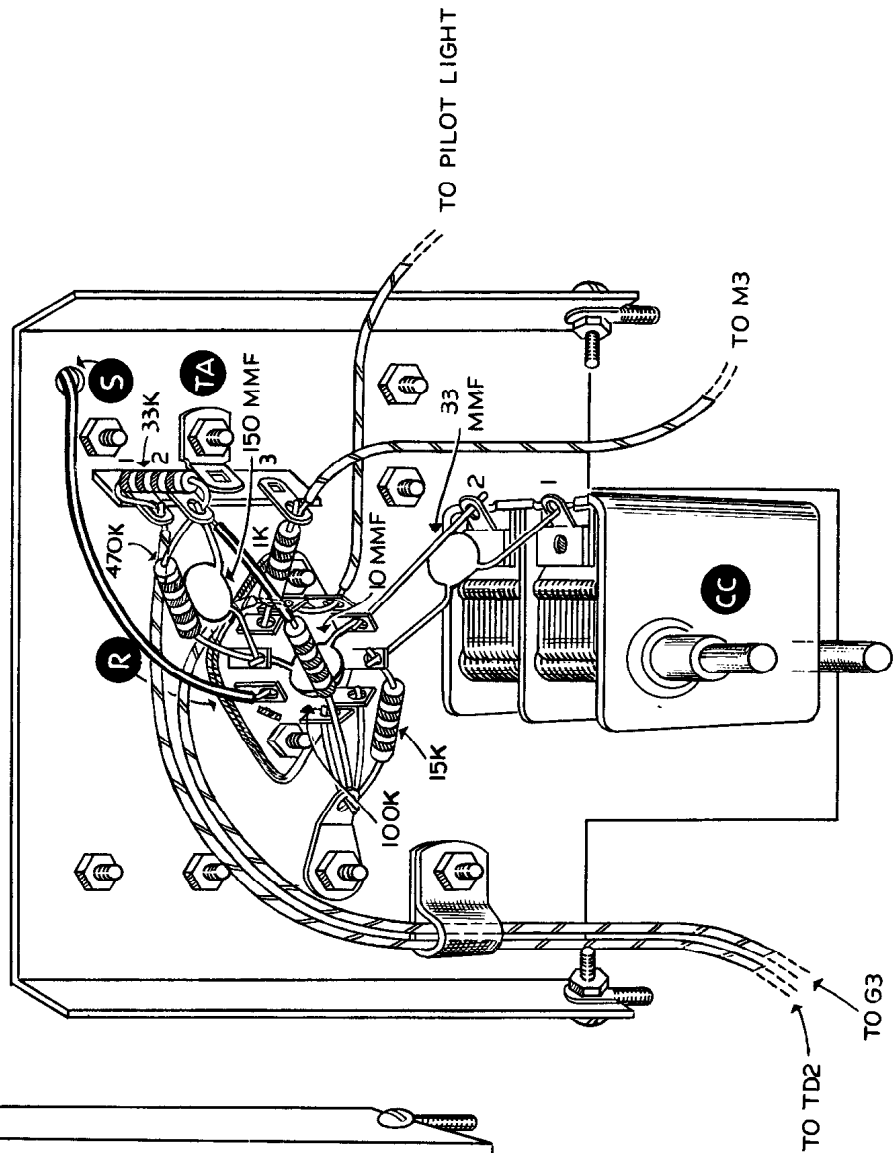

PICTORIAL 2

(S) means solder.

(NS) means do not solder yet.

- () Connect a 33 K Ω resistor from TA1 (NS) to TA2 (NS).
- () Connect a 470 K Ω resistor from TA2 (NS) to R2 (NS).
- () Connect a 150 $\mu\mu\text{f}$ (.00015 μfd) ceramic condenser from TA2 (NS) to R2 (NS).
- () Connect a 10 $\mu\mu\text{f}$ (.00001 μfd) ceramic condenser from R2 (S) to R6 (NS).
- () Connect a 1 K Ω resistor from R3 (S) to TA3 (NS).
- () Connect a 6" length of wire to TA3 (S). Leave the other end free.
- () Connect a 100 K Ω resistor from TA2 (S) (use sleeving) to the solder lug (NS).
- () Connect a wire about 9" long to TA1 (S). Run wire as shown in Pictorial 2 through the cable clamp. Leave the other end free.
- () Connect a wire about 9" long to R4 (NS). Run wire as shown through the cable clamp. Leave the other end free.
- () Connect a short bare wire from R4 (S) to R5 (NS).
- () Connect a wire about 4" long to R5 (S). Leave the other end free.
- () Connect a bare wire from R6 (S) to CC2 (S).
- () Connect a 33 $\mu\mu\text{f}$ (.000033 μfd) ceramic condenser from CC1 (S) to R7 (NS).
- () Connect a 15 K Ω resistor from R7 (S) to the solder lug (NS).
- () Connect a short bare wire from R8 (S) to the solder lug (NS).
- () Connect a short bare wire from R9 (S) to the solder lug (S).
- () Connect a bare wire to R1 (S). Cover with a 2 1/2" length of sleeving. Run wire through hole S to C1 (NS).
- () Connect a piece of bare wire 7 1/2" long to A1 (S). Slip a 1 7/16" length of sleeving over this wire and run through B1 (S), add a 4 1/2" length of sleeving and run through C1 (S), add a 1 1/8" length of sleeving and connect to D1 (NS).
- () Connect a short bare wire from BR12 on the band switch (S) to BF12 (S).
- () Connect a bare wire from BF1 (S) to A2 (S).
- () Connect a bare wire from BF2 (S) to B2 (S).
- () Connect a bare wire from BF3 (S) to C2 (S).
- () Connect a bare wire from BF4 (S) to D2 (S).
- () Connect a bare wire from BR1 (S) to A3 (S).
- () Connect a bare wire from BR2 (S) to B3 (S).

- () Connect a bare wire from BR3 (S) to C3 (S).
- () Connect a bare wire from BR4 (S) to D3 (S).
- () Connect coil E3 from BF5 (S) to BR5 (S).
- () Cover one bare lead from coil E3 with a 3 1/2" length of sleeving, and connect to D1 (S). Leave the other end free.
- () Connect coil E1 from BF6 (S) to CC3 (S).
- () Connect coil E2 from BR6 (S) to CC4 (S).

This completes the sub-chassis wiring.

ASSEMBLY OF CHASSIS

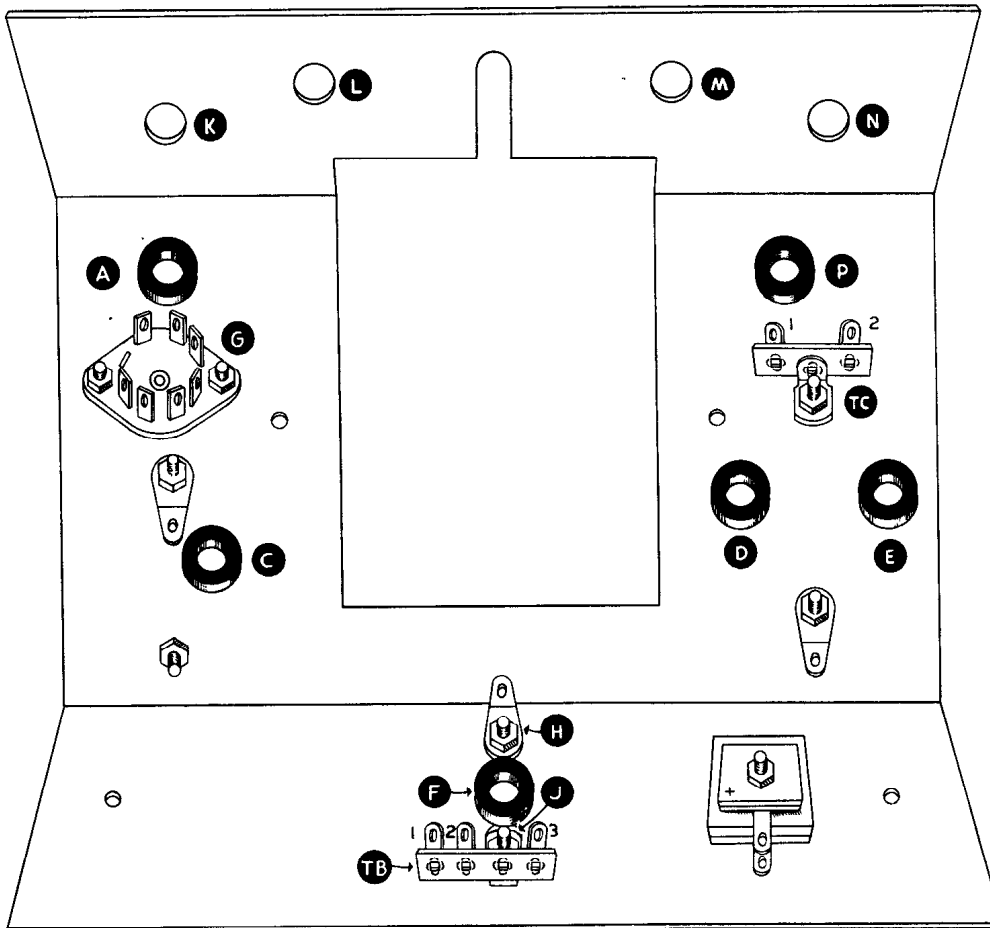

NOTE: Refer to Figure 6.

Figure 6

- () Install 3/8 rubber grommets in holes A, C, D, E, F and P.
- () Mount a 7-pin miniature socket in hole G, using 3-48 screws and nuts. Position as shown in Figure 6.
- () Mount the selenium rectifier with the side having the plus or cathode marking facing outward from the back of the chassis. Use a 1" 6-32 screw through the dimpled hole in the rear apron of the chassis. Fasten with a lockwasher and nut. Position as shown in Figure 6.

- () Mount the audio choke on top of the chassis to the rear of the tube socket. Use 3/8 6-32 screws, placing a solder lug under the nut nearest the tube socket and the lockwasher under the other nut. Position the solder lug as shown in Figure 6.
- () Mount the power transformer on top of the chassis opposite the audio choke. Position the transformer in such a manner that the red and yellow leads pass through the grommet nearest the chassis edge.
- () On the back mounting screw of the transformer, place a solder lug on the under side of the chassis. Position as shown in Figure 6.
- () On the front mounting screw, mount a 2-lug terminal strip TC. Position as shown in Figure 6. Use a lockwasher under the nut.
- () Using 3/8 6-32 screws, mount a solder lug at hole H and a 3-lug terminal strip TB at hole J, using a lockwasher on the latter. Position as shown in Figure 6.
- () Mount the sub-chassis to the chassis by inserting the sub-chassis spade bolts through the small holes on either side of the large chassis cutout. Care must be taken to prevent damage to the E band coils at this time. Lower the sub-chassis through the hole at a slight angle to clear the E band coils, and at the same time permit the band switch shaft to drop down into the slotted hole in the front of the chassis.

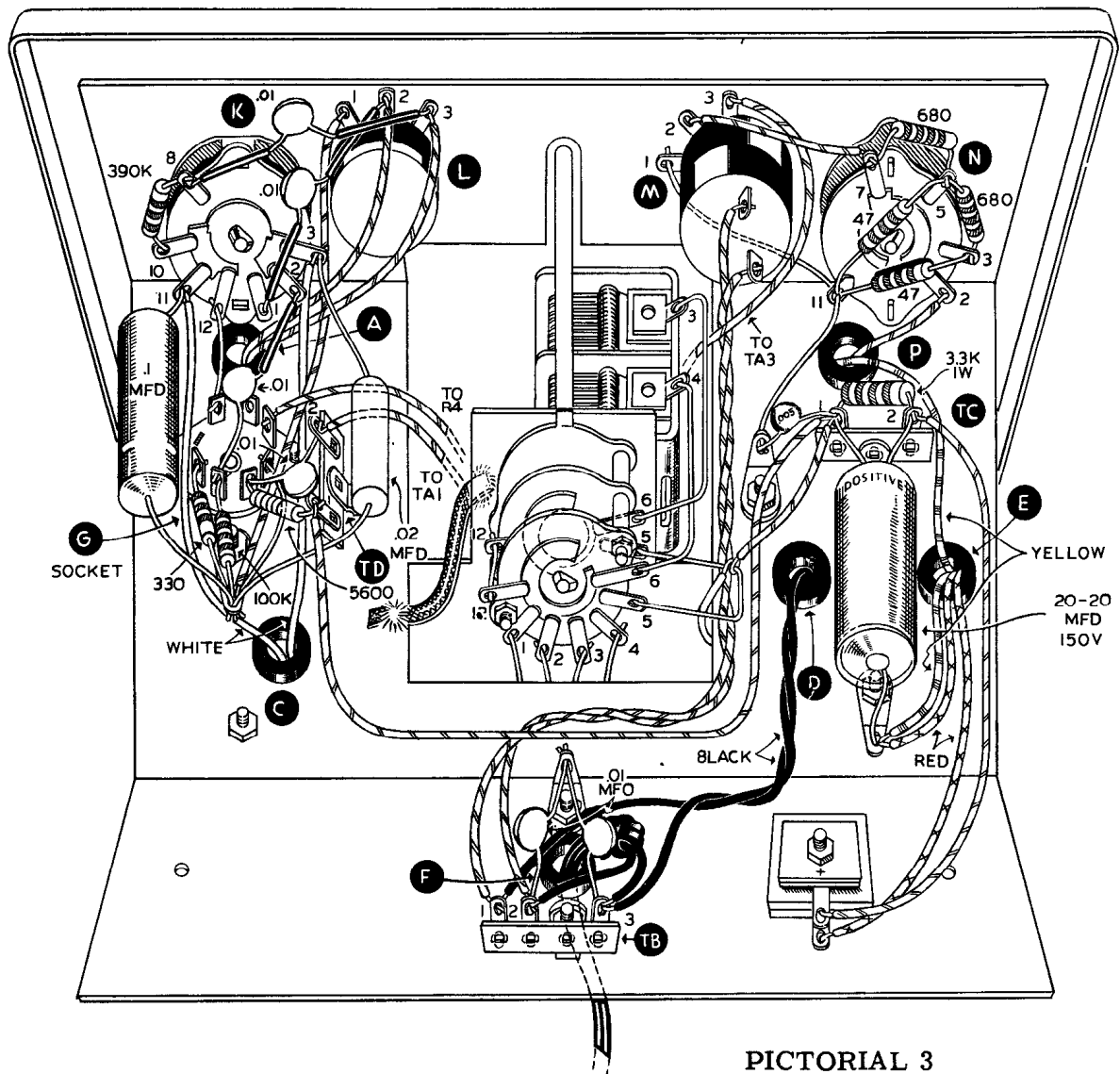

PICTORIAL 3

- () Referring to Pictorial 3, place a solder lug on the right hand spade bolt as viewed from the bottom, add a 6-32 nut and tighten.
- () On the left hand spade bolt, place a 2-lug terminal strip TD, a lockwasher and nut. Position as shown in Pictorial 3.
- () Solder a 1 3/4" length of shield braid directly on the chassis and sub-chassis as shown in Pictorial 3.
- () Mount the pilot light in the upper right panel hole, as viewed from the front. See Figure 7 for method of mounting.
- () Mount the three shielded connectors in the holes marked AF IN, AF OUT, and RF OUT. See Figure 8 for method of mounting.

NOTE: The controls are mounted through both the chassis and panel and hold the panel to the chassis. Refer to Figure 5 for method of mounting controls. The controls are lettered the same as the hole markings on Figure 6.

- () Mount the two position EXT-INT modulation switch in hole K. Position terminals as shown in Pictorial 3.
- () Mount the 1 megohm potentiometer L in hole L, and position terminals as shown in Pictorial 3.
- () Mount the 1 K Ω control M in hole M, and position terminals as shown in Pictorial 3.
- () Mount the three position attenuator switch N in hole N, and position terminals as shown in Pictorial 3.

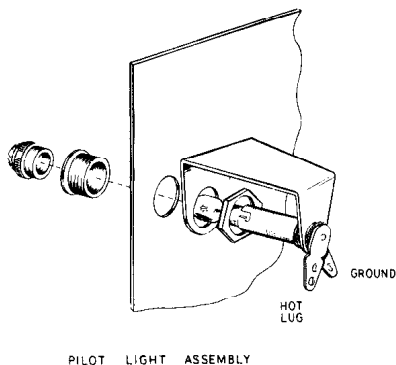

Figure 7

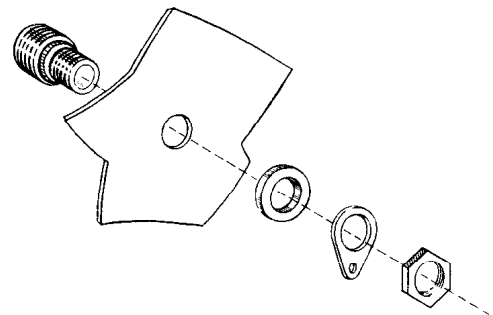

Figure 8

WIRING OF CHASSIS

NOTE: Exercise care when wiring chassis to avoid damage to E band coils.

- () Twist the two black wires from the power transformer together and connect either wire to TB3 (NS).
- () Connect the other black wire to TB1 (NS).
- () Connect a .01 μ fd (10,000 μ mf) ceramic condenser from TB3 (NS) to the solder lug on the opposite side of hole F (NS).
- () Connect a .01 μ fd ceramic condenser from TB2 (NS) to the same solder lug (S).
- () Connect either red wire from the transformer to the negative selenium rectifier terminal. (The terminal nearest the chassis.) (S).

- () Connect the other red wire to the solder lug directly below the rectifier (NS).
- () Connect either yellow wire from the transformer to this solder lug (NS).
- () Run the other yellow lead as shown in Pictorial 3, through the grommet P. Leave the other end free.
- () The 20-20 μ fd 150 volt filter condenser has two leads on the end marked "positive," and one lead on the other end. The condenser is mounted between the solder lug and the terminal strip TC as shown in Pictorial 3.
- () Connect the single negative wire to the solder lug (S).
- () Connect the two positive wires of the condenser to TC1 and TC2 (NS).
- () Connect a wire from the positive rectifier terminal (S) to TC2 (NS).
- () Connect a 3.3 K Ω 1 watt resistor from TC2 (S) to TC1 (NS).
- () Connect a .005 μ fd (5000 μ μ f) disc ceramic condenser from TC1 (NS) to adjacent solder lug (NS).
- () Twist two wires about 10" long together. Connect one pair of wire ends to the two switch terminals on the back of control M (S).
- () Run the wires as shown in Pictorial 3 to the terminal strip TB. Connect one wire to TB1 (S).

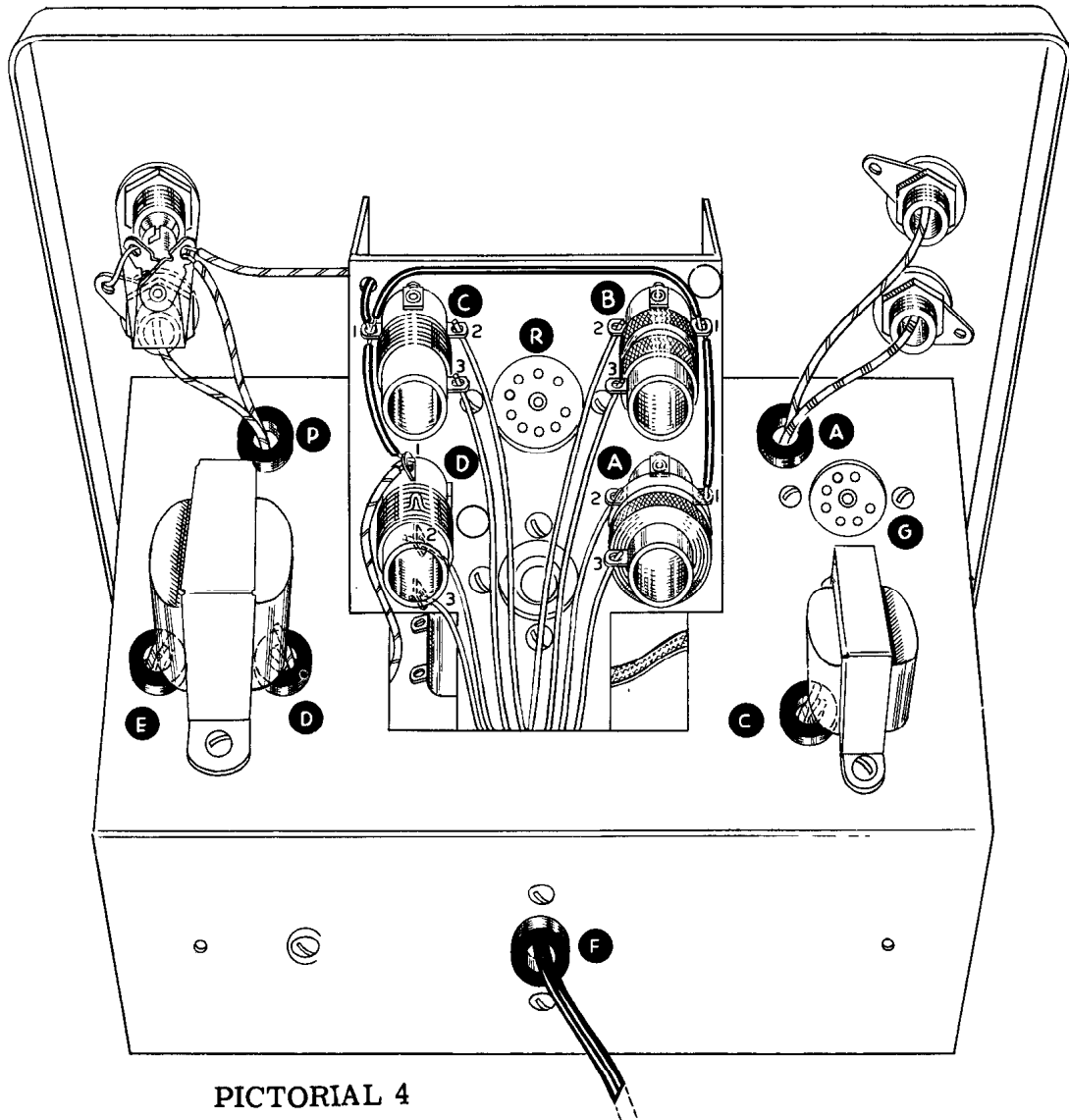

- () Connect the other wire to TB2 (NS).
- () Connect a bare wire to M1 (S). Run the wire through N11 (NS) to the solder lug adjacent to the large panel cutout (S).
- () Connect a 47 Ω resistor from N11 (NS) to N5 (NS).
- () Connect a 47 Ω resistor from N11 (S) to N3 (NS).
- () Connect a 680 Ω resistor from N3 (S) to N5 (NS).
- () Connect a 680 Ω resistor from N5 (S) to N7 (NS).
- () Connect a bare wire to N7 (S). Cover with a 1 1/2" length of spaghetti and connect to M2 (S).
- () Connect the free end of the wire coming from TA3 (see Pictorial 2) to M3 (S). Run wire as shown in Pictorial 3.
- () Connect a bare wire to N2 (S). Cover wire with a 2 1/2" length of spaghetti. Run wire through grommet P and connect to the center terminal of the RF OUT connection (S). See Pictorial 4.
- () Connect a short bare wire from the lug on the RF OUT connector (S) to the pilot light terminal nearest the panel (S).
- () Connect the free end of the yellow transformer wire to the rear pilot light terminal (NS).
- () Connect the free end of the wire coming from R5 (see Pictorial 2) to the same pilot light terminal (S).
- () Connect the remaining bare wire of coil E3 to TC1 (NS). (Use sleeving.)
- () Connect a wire to TC1 (S). Run wire along rear of chassis as shown in Pictorial 3, to TD1 (NS).
- () Connect a short bare wire from G1 (S) to K12 (S).
- () Connect the free end of the wire coming from R4 (see Pictorial 2) to G3 (S).
- () Connect the free end of the wire coming from TA1 (see Pictorial 2) to TD2 (NS).
- () Connect a short bare wire from G4 (S) to the solder lug adjacent to the tube socket (NS).
- () Connect a .01 μ fd ceramic condenser from G5 (NS) to TD2 (S).
- () Connect a 5600 Ω resistor from G5 (S) to TD1 (S).
- () Connect a 100 K Ω resistor from G6 (NS) to the solder lug (NS).
- () Connect a .01 μ fd ceramic condenser from G6 (S) to K2 (S). (Use sleeving.)
- () Connect a 330 Ω resistor from G7 (S) to the solder lug (NS).
- () Connect a 390 K Ω resistor from K8 (NS) to K10 (S).
- () Slip a 7/8" length of spaghetti over each lead of the .01 μ fd ceramic condenser, and connect the condenser from K8 (S) to L3 (NS).

- () Connect a wire to L3 (S). Run the wire through the grommet A to the center terminal of the AF IN connector (S). See Pictorial 4.
- () Connect either lead from the audio choke to K11 (NS).
- () Connect one lead of a .1 μ fd condenser to the solder lug (NS). NOTE: Any "outside foil" or "ground" markings on the paper capacitors can be disregarded in wiring this circuit. They may be connected with either "polarity."
- () Connect the other lead of this condenser to K11 (S). Position condenser as shown in Pictorial 3.
- () Slip a 3/4" length of sleeving over each lead of a .01 μ fd ceramic condenser. Connect one lead of the condenser to K1 (S). Connect the other lead to L2 (NS).
- () Connect a wire to L2 (S). Run the wire through the grommet A to the center terminal of the AF OUT connector (S).
- () Connect a wire from L1 (S) to the solder lug (NS). See Pictorial 3.
- () Connect the remaining lead from the audio choke to K3 (NS).
- () Cut one lead of a .02 μ fd condenser to 3/4" in length. Connect this lead to K3 (S).
- () Connect the other lead of this condenser to the solder lug (S).
- () Insert the line cord through the grommet F in the rear of the chassis. Tie a knot in the cord about 1 1/2" from the end. Connect one lead to TB2 (S).
- () Connect the other lead to TB3 (S).

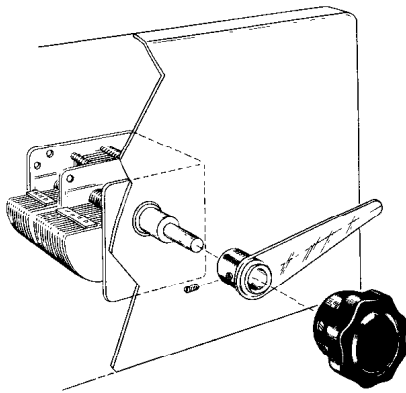

Figure 9

- () Mount pointer knobs on the five controls at the bottom of the panel. If the pointers do not line up properly with the markings on the panel, remove the knob, loosen the control nut and turn the control slightly until they do line up.
- () See Figure 9 for details of mounting the tuning controls. The pointer should be adjusted to cover the entire scale when the condenser is rotated.

- () Install the 12AU7 tube in the 9-pin socket on the sub-chassis.
- () Install the 6C4 tube in the 7-pin socket on the chassis.
- () Assemble the handle to the cabinet using two 10 x 24 screws.
- () Install the rubber feet on the cabinet as shown in Figure 10.
- () Slide the chassis into the cabinet with the line cord through the hole in the back of the cabinet.
- () Fasten the unit to the cabinet with two #6 sheet metal screws through the back of the cabinet.

Figure 10

INSTALL FEET
AS SHOWN

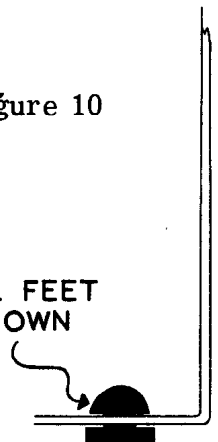

This completes the assembly and wiring of your Heathkit model SG-8 Signal Generator.

TEST LEAD ASSEMBLY

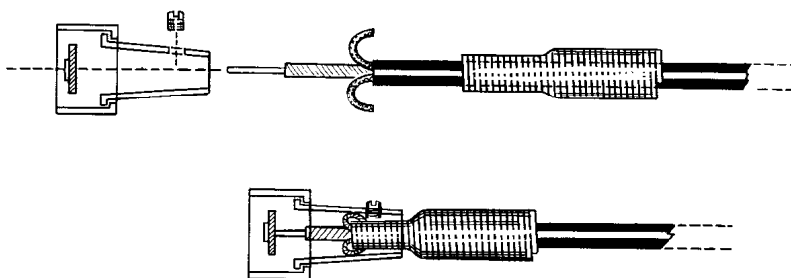

Figure 11

The test lead is assembled as shown in Figure 11. One end of the shielded cable is connected to the shielded plug; the other end has alligator clips mounted on it for connection to the equipment under test. First, remove the spring cable guard from the connector plug by loosening the screw in the side of the plug. Slide this spring over the shielded cable, with the small end of the spring toward the end that is to be connected to the plug. The outside insulation on the cable is then cut back for a length of about 3/4", then flare the shield braiding at the end of the cable so that it may be pushed back over the small end of the spring cable guard. The inner connector is then stripped for a length of approximately 1/8". The assembly at this point is slid back into the connector so that the inner coaxial wire passes through the rivet in the insulated end of the connector, the cable guard with the shielded braid flared over the end is pushed back into the connector and the screw tightened to hold it in place. Solder the inner connector.

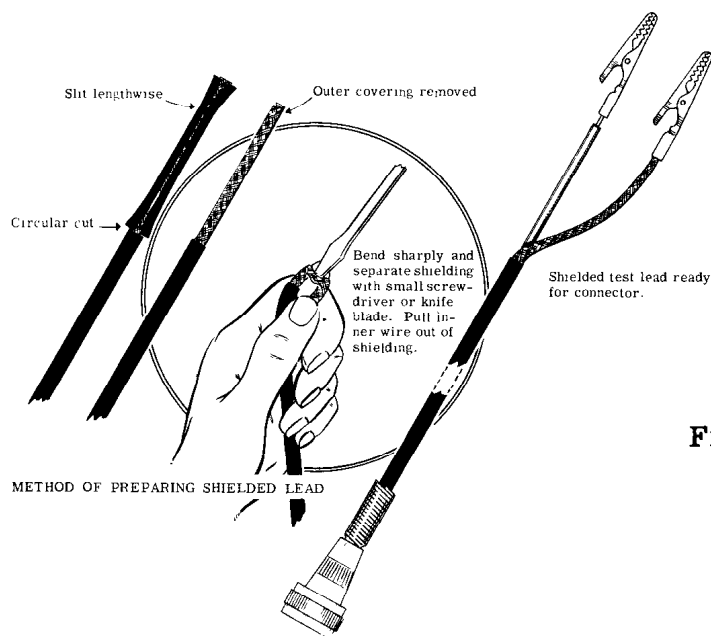

Figure 12

On the other end of the shield cable, the outer insulation is cut back about 4" and the cable prepared as shown in Figure 12. Solder alligator clips to both the inner conductor and the shield braid.

ACCURACY

Any signal generator is designed as a convenient and controllable source of modulated or unmodulated signals. No signal generator is designed as a frequency standard. Expensive standard signal generators have fairly accurate (3 to 20%) attenuators which control the output voltage and the calibration accuracy is rarely closer than 1%. The Heathkit Signal Generator may be expected to fall within 2 to 3% of the frequency calibration, which is quite satisfactory for service work and alignment. In receiver adjustment, the frequency at which the particular adjustment is made is rarely critical but the adjustment itself for maximum signal output from the

receiver is frequently quite critical. For accurate calibration of home built receivers or equipment, proceed as follows. Make a rough calibration with the signal generator. Then, with a receiver, tune in WWV (Bureau of Standards) at 2.5, 5, or 10 mc. Set the signal generator to a suitable sub-harmonic, such as 500 or 1000 kc, and adjust the generator for zero beat. Now harmonics of the signal generator occur every 500 kc or 1 megacycle, and these harmonics may be used to give accurate calibrations at points 500 or 1000 kc apart, such as 2500 kc, 3000 kc, 3500 kc, 4000 kc, etc. These known frequency points can be marked on the dial of the equipment being calibrated. The object of the rough calibration is merely to furnish a means of identifying for example, the 3000 kc point from the 2500 kc or 3500 kc points. For calibration of higher frequency equipment, a choice of higher sub-harmonic will reduce the confusion between the multitude of harmonics and will also insure adequate signal strength. When checking the calibration accuracy of the Heathkit Signal Generator, the most convenient standards of comparison of sufficient accuracy are broadcast stations of known frequency. Crystal oscillators of standard frequency when zero beat against WWV, are also convenient to use if available. The use of receiver dial calibrations is frequently not of sufficient accuracy to warrant consideration.

Output Voltage: The RF signal strength going into the output control depends upon the strength of oscillation of the 12AU7 oscillator. In all variable frequency oscillators the amplitude will vary with the tuning condenser setting. With careful design the variation may be minimized. In the Heathkit Signal Generator, the variation is kept down to a ratio of about 2 1/2 to 1 on each band except band E, where the L/C (inductance to capacitance) ratio becomes sufficiently unfavorable that oscillation may drop off rapidly in strength when the condenser is near maximum capacity. However, even on this band, the output of the SG-8 is in excess of 100,000 microvolts which is more than sufficient for the average application in which this generator will be used.

IN CASE OF DIFFICULTY

1. Recheck the entire wiring. Follow each lead and color it on the pictorial with a colored pencil. If possible, have a friend recheck the wiring for you. Most cases of difficulty result from wrong or reversed connections. In this unit, there is also the possibility of shorts to the chassis occurring on some of the bare wire connections from the coils. These wires should be carefully spaced away from the chassis when the instrument is assembled.
2. Check the test lead with an ohmmeter to be sure there are no shorts between the inner and outer conductor caused by overheating during the soldering process.
3. If the wiring is found to be correct and the signal generator still refuses to work, try changing tubes. It is possible that one of the tubes is defective.
4. Check the voltages. A voltage chart is included showing the normal voltage to be expected at the pins of the tube sockets. These voltages were measured with an 11 megohm input vacuum tube voltmeter. A normal variation of $\pm 15\%$ is to be expected. With regular voltmeters, readings may be very much lower. All voltages are DC unless otherwise indicated.
5. If only one band on the signal generator is inoperative, it is very likely that the coil associated with that band has become damaged. An ohmmeter connected between the terminals of the coil should show continuity. If it does not, one section of the winding is open.

VOLTAGE CHART

TUBE	Pin 1	Pin 2	Pin 3	Pin 4	Pin 5	Pin 6	Pin 7	Pin 8	Pin 9
6C4	65	NC	6.3 AC	0	65	-0.5	1		
12AU7	78	*2 to -15	3.5	6.3 AC	6.3 AC	*75-85	*-3 to -30	0	0

*Dependent upon frequency.

NC - no connection.

BIBLIOGRAPHY

Marcus and Levy; Elements of Radio Servicing
 Kiver, Milton S.; How to Understand and Use TV Test Instruments
 Johnson, J. Richard; How to Use Signal and Sweep Generators

USE OF THE RF SIGNAL GENERATOR

This signal generator can be used to align radio receivers. It furnishes a source of radio frequency or modulated radio frequency by means of signal generator fundamental frequencies between 160 kc and 100 megacycles (1 megacycle equals 1000 kilocycles) and useful harmonics of the signal generator may be used to over 200 megacycles.

The RF Signal Generator will be found a most valuable aid to the radio service man as well as the hobbyist. The day-to-day "bread and butter" job of the signal generator is receiver alignment. To save time and money, the service man or hobbyist should use a technique which can be applied to the majority of sets encountered in normal work. After using the technique a few times, it becomes virtually a matter of "second nature" and so easily used that the average set may be completely aligned in a matter of minutes.

The majority of single band radio receivers have nowadays become quite standardized and therefore it is seldom necessary in alignment of receivers to refer to the specific manufacturer's alignment instruction. In the average receiver, it is generally only necessary to take note of the IF frequency (most home radios and automobile radios employ a 455 KC IF frequency).

Figure 13 is a schematic diagram of a small, single-band superheterodyne radio receiver. The majority of single-band sets use a circuit similar to this one. Variations likely to be found are as follows:

- (1) Use of an antenna coil rather than a rod-type or loop antenna.
- (2) Use of a separate oscillator rather than a pentagrid converter.
- (3) Trimmer tuning of IF and RF stages in place of iron core slugs.
- (4) Use of an RF stage ahead of the mixer.
- (5) More than one IF stage.

These variations do not appreciably affect the alignment technique and the following step-by-step procedure may be used directly in most cases:

- (1) Turn both the signal generator and the receiver on and allow several minutes for both units to reach normal operating temperature. (It is a good idea to leave the signal generator on during all working hours.)

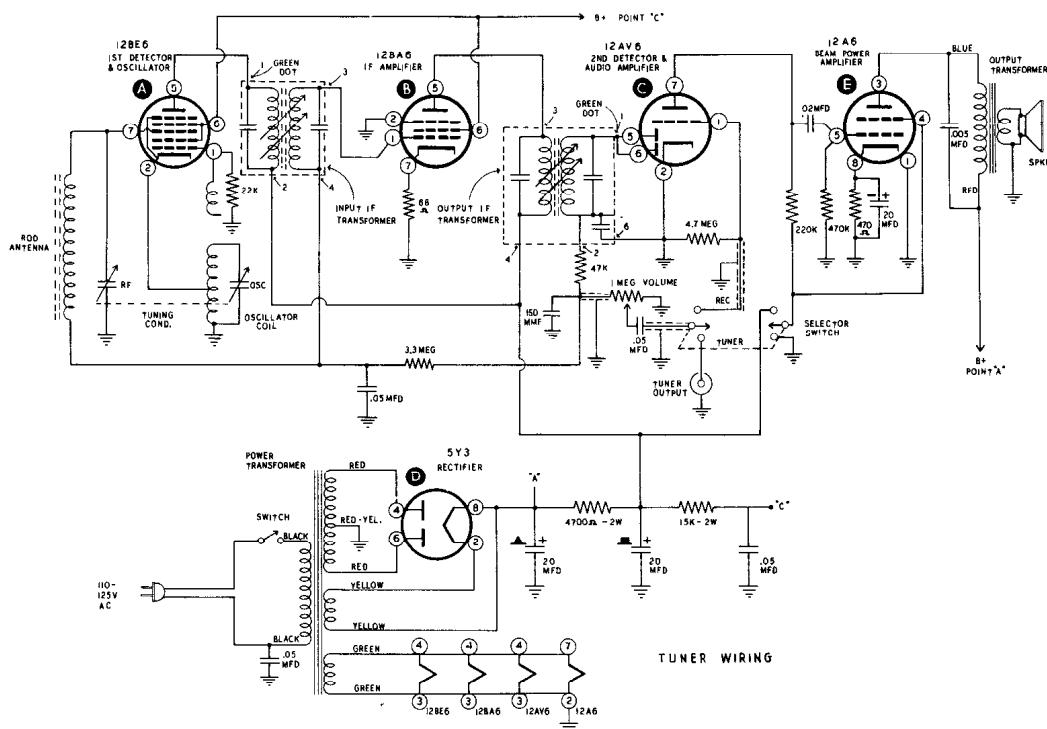

Figure 13

- (2) Connect an output indicator to the receiver. This may be an AC voltmeter connected directly across the loudspeaker voice coil; however, a VTVM connected to measure AVC voltage is by far the most desirable method.
- (3) Short out the local oscillator tuning circuit temporarily. The simplest way to accomplish this is merely by clipping a short piece of wire across the rotor and stator plates of the oscillator section of the tuning condenser. Set the receiver dial to the low frequency end, somewhere near 550 KC.
- (4) Connect the signal generator to the antenna terminals of the receiver or if the receiver employs a loop antenna or rod antenna, couple the output of the generator to the antenna system through a one or two turn loop of wire around the antenna. In cases where an RF stage is used ahead of the mixer, connect the signal generator to the injection grid of the mixer stage. Set the signal generator to the IF value of the set. (455 KC is generally the accepted standard.) Use a modulated signal if an AC voltmeter is employed as an output indicator. An unmodulated signal is used provided the AVC voltage is used as an output indication.
- (5) Using the lowest range of the output indicator, increase the output of the signal generator until a reading can just be obtained.
- (6) Adjust the IF transformers for maximum reading on the output indicator. Reduce the signal generator output as necessary to keep a low reading on the output indicator. Repeat the adjustments at least once to correct for any interaction between primary and secondary windings on the individual transformers. Interaction is most likely to occur in sets where adjustment is by means of iron-core slugs rather than trimmer condensers.
- (7) Next, remove the short across the local oscillator and tune the receiver to its highest frequency setting (somewhere around 1600 KC). Set the signal generator to the same frequency and adjust the oscillator trimmer for maximum output.
- (8) Now tune the receiver and signal generator to 1400 KC and adjust the RF trimmer for maximum output.
- (9) Turn the signal generator to 600 KC and tune the receiver to the low frequency end of the dial. Now "rock" the receiver tuning condenser while at the same time adjusting the trimmer condenser for maximum output. In sets using especially shaped plates in the oscillator section of the tuning condenser, generally no trimmer condenser will be found. Also, in some sets, the low frequency oscillator adjustment will be through means of an iron-core slug in the oscillator coil rather than a trimmer condenser.
- (10) Steps 7, 8 and 9 should be repeated if it was found necessary to readjust the trimmer condenser (or iron-core slug) as directed in Step 9.

The alignment procedure for multi-band AM superheterodyne receivers is essentially the same as outlined above for a single-band set. First the IF stages are aligned using the same technique as given in Steps 1 through 6. Next, each RF band is aligned separately, starting with the highest frequency band and working towards the lowest. The technique given may be used but with corresponding frequency settings for each band.

If the oscillator and RF trimmer condensers for the different bands are not well identified, a simple technique may be employed to locate the proper adjustment screws. Turn the receiver band switch to the highest frequency band and tune in a signal, using a short-wave station or a signal from the RF generator. Using an insulated alignment tool, try compressing the different oscillator trimmers until one is found that changes the tuning of the signal. Do not compress the oscillator trimmer condensers by turning the adjustment screws, just press the leaves of the condenser together temporarily. This method will identify the trimmers for each band without drastically changing their original setting. After identifying the oscillator trimmer for the band in this manner, repeat the technique to identify the RF trimmer. Turn to the next band and repeat the method, being careful not to touch the trimmers already identified.

Should the oscillator trimmer of the short-wave band have a wide tuning range, it may be possible to pick up and "peak" a signal with two different settings of the trimmer. Should this be the case, use the setting with the least capacity to insure that the oscillator is tuned above the incoming signal.

FM RECEIVER ALIGNMENT

It is the standard practice to align the IF amplifier of an FM receiver (tuner) before aligning the RF and oscillator sections just as in AM receivers. However, the exact technique of alignment depends on whether a limiter discriminator or a ratio detector is used. Where a limiter and discriminator are used, usual practice is to align the IF section up to the input of the limiter first. Then align the discriminator as a separate step. When aligning the IF, RF and oscillator sections, the grid current of the limiter may be used as an output indicator. Although the voltage across a limiter grid resistor, measured with a VTVM, will serve in many cases, it is not an ideal indication. A typical limiter and discriminator stage is shown in Figure 14. Proper alignment technique for the complete FM receiver is as follows:

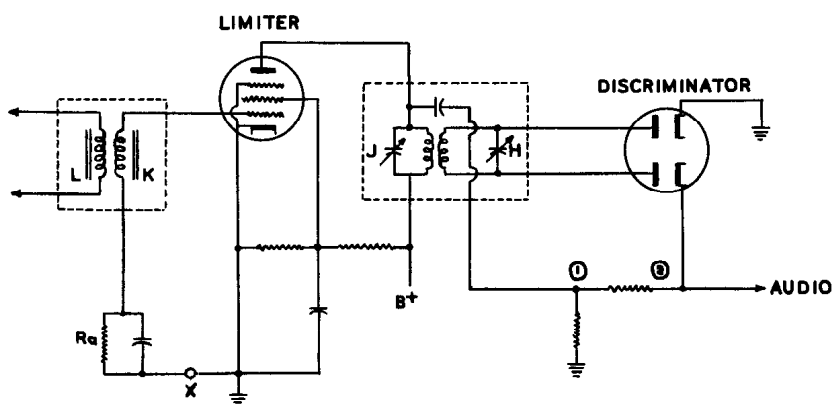

Figure 14

- (1) Connect an output indicator by (1) attaching a VTVM across the limiter grid resistor, or (2) breaking the circuit at the grid of the limiter and inserting a microammeter with a maximum range of around 150 microamps. If this method is used, be sure and bypass the meter with a .05 μ fd condenser to ground. See point X in Figure 14.
- (2) Connect a signal generator to the input of the mixer stage and turn on both the signal generator and the receiver. A sufficient warm-up time must be allowed to permit both the receiver and the generator to reach their normal operating temperature. In the case of FM receivers this is usually 15 to 20 minutes before complete stabilization can be obtained. Adjust the signal generator to the IF value of the set. This is usually 10.7 mc. The unmodulated RF output of the signal generator is used.
- (3) Peak all IF trimmers for maximum meter readings. If the IF is considerably out of alignment so that very little meter reading is obtained, it may be necessary to connect the signal generator to the last IF stage and align this portion of the circuit first. Then work back toward the mixer stage, rechecking previous IF adjustments at each point.
- (4) Connect a VTVM between point 1 and ground as shown in Figure 14. Adjust the trimmer or slug "J" for maximum reading using a low VTVM range.
- (5) Transfer the VTVM connection to point 2 and adjust trimmer "H" for a minimum voltmeter reading.

- (6) Transfer the signal generator lead to the antenna terminals and align the RF and oscillator trimmers, using essentially the same technique as is outlined for AM receiver adjustment, except the frequency settings will fall between 88 mc and 108 mc. The output indicator for this adjustment is the same as discussed in Step 1. Lastly, adjust the antenna trimmer for maximum indication or volume using the receiver's own antenna and at its permanent location.

RATIO DETECTORS

The following technique may be used for alignment of ratio detector FM receiver circuits. Refer to Figure 15.

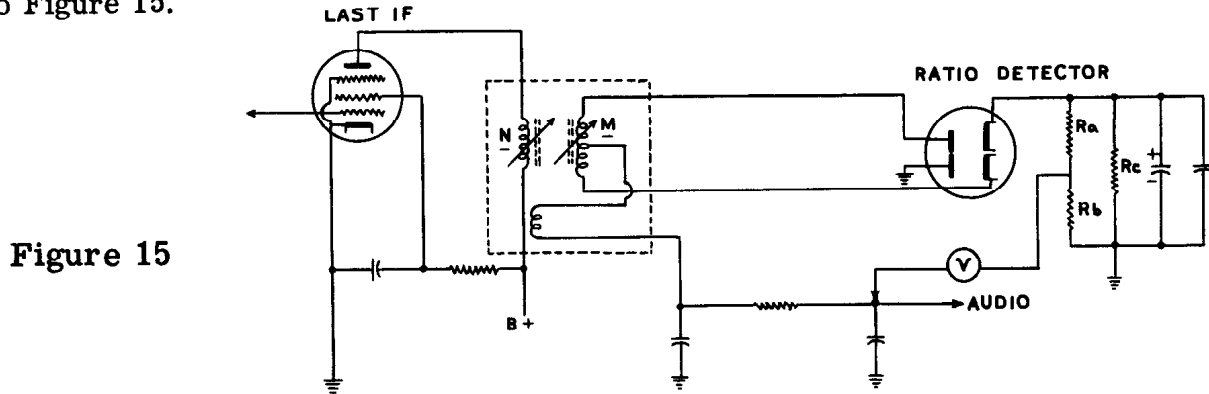

Figure 15

- (1) Connect a VTVM or high resistance DC voltmeter across RC.
- (2) As before, both receiver and signal generator should be allowed to warm up. The receiver dial should be set to the low frequency end (88 mc) and the signal generator adjusted to give an unmodulated signal at the receiver IF. Connect the signal generator to the input of the mixer stage as before.
- (3) Adjust all IF trimmers (or slugs) for a maximum reading on the meter, using a low range and the least signal generator output possible. Repeat the adjustments at least twice to correct for any interaction. Be sure slug N is accurately adjusted.
- (4) Connect two 100,000 Ω 1/2 watt resistors across RC (RA and RB) and connect the voltmeter as shown in Point V in Figure 15.
- (5) Adjust the trimmer (or slug) M for a zero output indication on the meter.
- (6) Align the RF and oscillator stages using the techniques previously described, measuring the voltage across RC as an output indication.

SERVICING BY SIGNAL INJECTION

THE AUDIO AMPLIFIER

The block diagram for a typical audio amplifier is shown in Figure 16. Let us assume, for the moment, that the amplifier is "dead" due to a defective second audio stage.

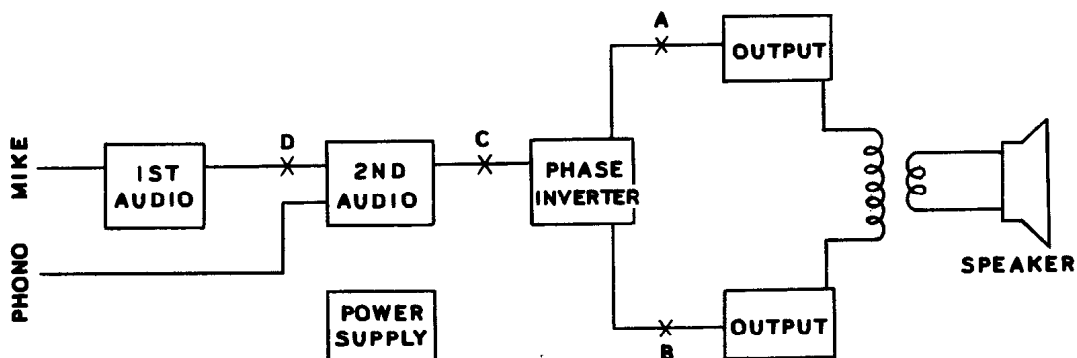

Figure 16

In servicing the equipment, the first step, of course, is to check for obvious defects such as lack of B plus, defective tubes and so forth. After these preliminary tests have been made, the Heathkit RF Signal Generator is used as an audio signal source by plugging the output cable into the "AF-OUT" jack. The level of the audio tone obtained is adjusted by the "AF IN-OUT" control. The MODULATION control should be set in the "INT." position.

Check the operation of the output stages by connecting the ground lead of the output cable to the chassis of the amplifier or circuit ground and touching the "hot" lead of the output cable to the grid of first one output tube Point A in Figure 16 then to the other output tube Point B in Figure 16. All of these tests must be made through a .05 μ fd condenser. In this fashion the operation of each output stage is checked individually. As each grid is touched, a clear audio tone should be heard in the loudspeaker.

Next, the operation of the phase inverter stage can be checked by transferring the hot lead (together with a .05 μ fd condenser) to the input of this stage (Point C in Figure 16). Again, a clear signal should be heard from the loudspeaker. The tone should be louder than before. If too loud, the volume can be reduced, using the "AF IN-OUT" control.

The second audio stage is now checked by transferring the hot signal generator lead to the input of this stage, Point D in Figure 13. If this stage is dead, no more tone will be heard in the loudspeaker. Having isolated the trouble to a specific stage, it is now a simple matter to check DC operating voltages and parts until the defective component is found.

As each amplifier stage is checked, work back towards the input stage (first audio), a definite increase in volume should have been noted. It may even be necessary to reduce the volume using the control mentioned. This, then, provides an additional test technique. A weak stage can be identified if little or no increase in volume is heard as the "hot" lead is transferred past the stage. Be careful when interpreting the results of this test, for overloading a stage may cause apparent loss in volume even when the stage itself is in good condition. Therefore, when attempting to isolate a "weak" stage, be sure to keep the signal level at a reasonable point.

AN OPEN COUPLING CONDENSER may be isolated using this signal injection technique. Refer to Figure 17, which is part of a conventional resistance coupled amplifier. If coupling condenser C-1 should open, little or no signal would be transferred between stages. To check the condition of the coupling condenser, it is first necessary to connect a small blocking condenser in series with the "hot" lead of the signal generator. The condenser may have a value of .05 μ fd. The exact value is not at all critical. The blocking condenser permits the "hot" lead to be placed on the plate of a tube without danger of the DC voltage present injuring circuits within the generator.

If a clear tone is heard when the "hot" lead is touched to Point E but not when touched to Point F, we are reasonably sure Condenser C-1 is open.

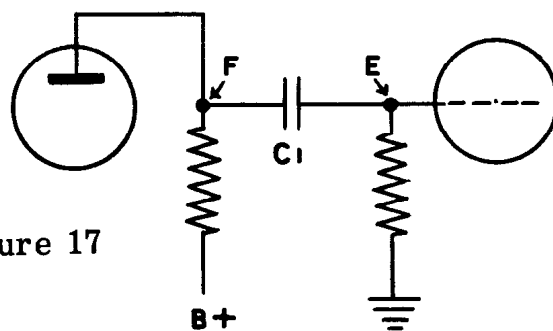

Figure 17

RADIO RECEIVER

Referring to the block diagram for a typical small AM receiver, Figure 18, again the technique of signal injection, is essentially the same as that used in the case of the audio amplifier. That is, a substitute signal is injected into each stage starting at a convenient point and working back towards the "front" of the equipment. In the case of the audio amplifier, we work towards the input jack of the amplifier. In the case of the radio receiver, we work towards the antenna.

There is one important difference between using the signal injection technique on an audio amplifier and using the same technique on a receiver. In the case of the amplifier, as we have seen, the audio output signal obtained from the signal generator was used exclusively; however, when trouble-shooting a receiver, it becomes necessary to switch to an RF signal when checking stages

ahead of the second detector. In addition, the frequency of the RF signal will have to be changed to match the operating frequency of the stages being checked. A rather common receiver complaint is that the "set is dead". When such a complaint is caused by a defective local oscillator, the trouble may prove somewhat difficult to isolate.

As before, the first step in servicing the equipment is to check for the obvious defects. A quick check with a DC voltmeter will indicate whether or not the power supply is operating.

To isolate the trouble to a stage as rapidly as possible, a technique which experienced service men often employ may be used. Instead of stage-by-stage testing, the set is considered to consist of major sections and primarily isolation of the trouble may be made on this basis. The audio signal obtained from the Heathkit RF signal generator may be used to inject a signal at the input of the first audio stage (Point H in Figure 18). If a loud clear tone is heard, we know immediately that the entire audio section of the receiver is operating and can forget about these stages for the time being.

Shift the output cable of the signal generator to the RF OUT jack and adjust the controls to give a modulated RF signal at the IF value for the receiver. (In most cases this will be 455 KC). Using a 50 $\mu\mu\text{f}$ condenser in series with the "hot" lead, inject the signal at the input of the IF stage (Point J in Figure 18). The use of a small coupling condenser in this case is to minimize detuning of the IF and RF stages for the signal generator lead. If a tone is once again heard in the loudspeaker, we know that the IF stage, under test, is in satisfactory operation.

Repeat the signal injection tests until the defective stage in the receiver has been located. From this point on, then, it is a simple matter to isolate the defective components causing the receiver to be inoperative.

Variations of a signal injection technique may be used for servicing FM and TV receivers as well as the herein discussed AM receivers and audio amplifiers.

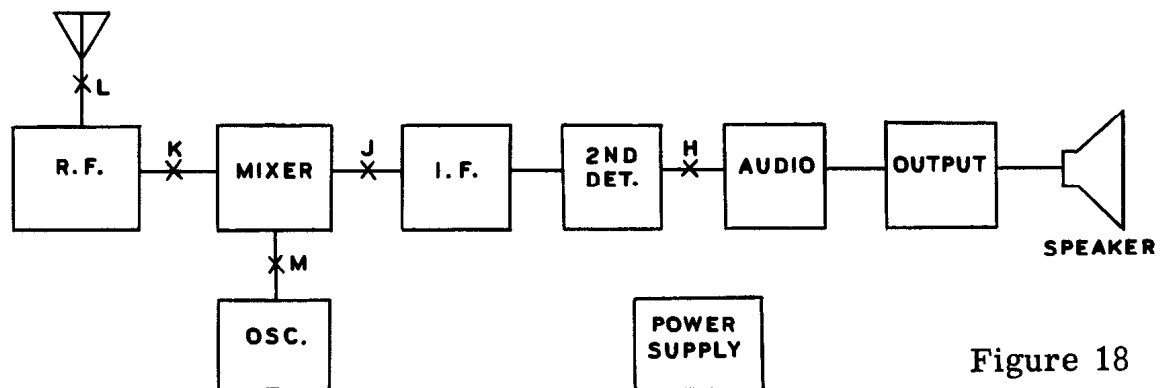

Figure 18

REPLACEMENTS

Material supplied with Heathkits has been carefully selected to meet design requirements and ordinarily will fulfill its function without difficulty. Occasionally improper instrument operation can be traced to a faulty tube or component. Should inspection reveal the necessity for replacement, write to the Heath Company and supply all of the following information:

- A. Thoroughly identify the part in question by using the part number and description found in the manual parts list.
- B. Identify the type and model number of kit in which it is used.
- C. Mention the order number and date of purchase.
- D. Describe the nature of defect or reason for requesting replacement.

The Heath Company will promptly supply the necessary replacement. Please do not return the original component until specifically requested to do so. Do not dismantle the component in

question as this will void the guarantee. If tubes are to be returned, pack them carefully to prevent breakage in shipment as broken tubes are not eligible for replacement. This replacement policy does not cover the free replacement of parts that may have been broken or damaged through carelessness on the part of the kit builder.

SERVICE

In event continued operational difficulties of the completed instrument are experienced, the facilities of the Heath Company Service Department are at your disposal. Your instrument may be returned for inspection and repair for a service charge of \$3.00 plus the cost of any additional material that may be required. THIS SERVICE POLICY APPLIES ONLY TO COMPLETED INSTRUMENTS CONSTRUCTED IN ACCORDANCE WITH THE INSTRUCTIONS AS STATED IN THE MANUAL. Instruments that are not entirely completed or instruments that are modified in design will not be accepted for repair. Instruments showing evidence of acid core solder or paste fluxes will be returned not repaired.

The Heath Company is willing to offer its full cooperation to assist you in obtaining the specified performance level in your instrument. Factory repair service is available for a period of one year from the date of purchase or you may contact the Engineering Consultation Department by mail. For information regarding possible modification of existing kits, it is suggested that you refer to any one or more of the many publications that are available on all phases of electronics. They can be obtained at or through your local library, as well as at any electronic outlet store. Although the Heath Company sincerely welcomes all comments and suggestions, it would be impossible to design, test, evaluate and assume responsibility for proposed circuit changes for specific purposes. Therefore, such modifications must be made at the discretion of the kit builder according to information which will be much more readily available from some local source.

SHIPPING INSTRUCTIONS

Before returning a unit for service, be sure that all parts are securely mounted.

ATTACH A TAG TO THE INSTRUMENT GIVING
NAME, ADDRESS AND TROUBLE EXPERIENCED.

Pack in a rugged container, preferably wood, using at least three inches of shredded newspaper or excelsior on all sides. DO NOT SHIP IN THE ORIGINAL KIT CARTON AS THIS CARTON IS NOT CONSIDERED ADEQUATE FOR SAFE SHIPMENT OF THE COMPLETED INSTRUMENT. Ship by prepaid express if possible. Return shipment will be made by express collect. Note that a carrier cannot be held liable for damage in transit if packing, in HIS OPINION, is insufficient.

SPECIFICATIONS

All prices are subject to change without notice. The Heath Company reserves the right to discontinue instruments and to change specifications at any time without incurring any obligation to incorporate new features in instruments previously sold.

WARRANTY

Heath Company warrants that for a period of three months from the date of shipment, all Heathkit parts shall be free of defects in materials and workmanship under normal use and service and that in fulfillment of any breach of such warranty, Heath Company shall replace such defective parts upon the return of the same to its factory. The foregoing warranty shall apply only to the original buyer, and is and shall be in lieu of all other warranties, whether express or implied and of all other obligations or liabilities on the part of Heath Company and in no event shall Heath Company be liable for any anticipated profits, consequential damages, loss of time or other losses incurred by the buyer in connection with the purchase, assembly or operation of Heathkits or components thereof. No replacement shall be made of parts damaged by the buyer in the course of handling or assembling Heathkit equipment.

NOTE: The foregoing warranty is completely void and we will not replace, repair or service instruments or parts thereof in which acid core solder or paste fluxes have been used.

HEATH COMPANY

<u>PART No.</u>	<u>PARTS Per Kit</u>	<u>DESCRIPTION</u>	<u>PART No.</u>	<u>PARTS Per Kit</u>	<u>DESCRIPTION</u>
Resistors			Sockets-Knobs-Jacks		
1-1	2	47 Ω	100-M10	1	Indicator assembly
1-4	1	330 Ω	432-3	3	Shielded connector
1-7	2	680 Ω	434-15	1	7-pin miniature socket
1-9	1	1 KΩ	434-16	1	9-pin miniature socket
1-3A	1	3.3 KΩ 1 watt	434-22	1	Pilot light socket
1-18	1	5600 Ω	462-18	1	Skirtless knob
1-21	1	15 KΩ	462-19	5	Skirted knob
1-24	1	33 KΩ			
1-26	2	100 KΩ	Hardware		
1-32	1	390 KΩ	250-2	4	3-48 x 1/4 screw
1-33	1	470 KΩ	250-7	3	6-32 x 3/16 screw
Condensers			250-8	2	#6 x 3/8 sheet metal screw
21-3	1	10 μμf (.00001 μfd)	250-9	8	6-32 x 3/8 screw
21-7	1	33 μμf (.000033 μfd)	250-13	1	6-32 x 1 screw
21-11	1	150 μμf (.00015 μfd)	250-15	1	8-32 x 1/8 set screw
21-16	6	.01 μfd	250-83	2	#10 x 1/2 handle screw
21-27	1	.005 μfd (5000 μμf)	251-1	2	6-32 spade bolt
23-8	1	.02 μfd	252-1	4	3-48 nut
23-28	1	.1 μfd	252-3	20	6-32 nut
25-7	1	20-20 μfd 150 v	252-7	5	Control nut
26-17	1	450 μμf dual tuning	253-10	4	Control nickel washer
Controls-Switches			253-22	3	3/4 flat washer
10-32	1	1 megohm control	254-1	17	#6 lockwasher
19-18	1	1 KΩ control with switch	254-4	5	Control lockwasher
63-67	1	5 position band switch	259-1	5	#6 solder lug
63-69	1	2 position modulation switch	Clips-Plugs-Wire		
63-70	1	3 position attenuator switch	89-1	1	Line cord
Coils-Chokes-Transformers			207-3	1	1/8" cable clamp
40-47A	1	Oscillator coil band A	260-1	2	Alligator clip
40-47B	1	Oscillator coil band B	340-2	1	length #20 bare wire
40-47C	1	Oscillator coil band C	343-3	1	length Shielded test lead
40-47D	1	Oscillator coil band D	344-1	1	roll Hookup wire
40-47E	1	Oscillator coil band E	345-1	1	length Shield braid
46-1	1	AF choke	346-1	1	length Spaghetti (sleeving)
54-2	1	Power transformer	432-1	1	Shielded plug
Tubes-Lamps-Rectifiers			Chassis-Panel-Manual		
57-2	1	Selenium rectifier	90-14	1	Cabinet
411-4	1	6C4 tube	200-M54	1	Chassis
411-25	1	12AU7 tube	200-M55	1	Sub-chassis
412-1	1	#47 pilot light	203-26F67	1	Panel
Grommets-Feet-Terminal Strips			211-4	1	Handle
73-1	6	3/8 grommet	595-73	1	Instruction Manual
261-1	4	Rubber feet			
431-2	2	2-lug terminal strip			
431-3	2	3-lug terminal strip			

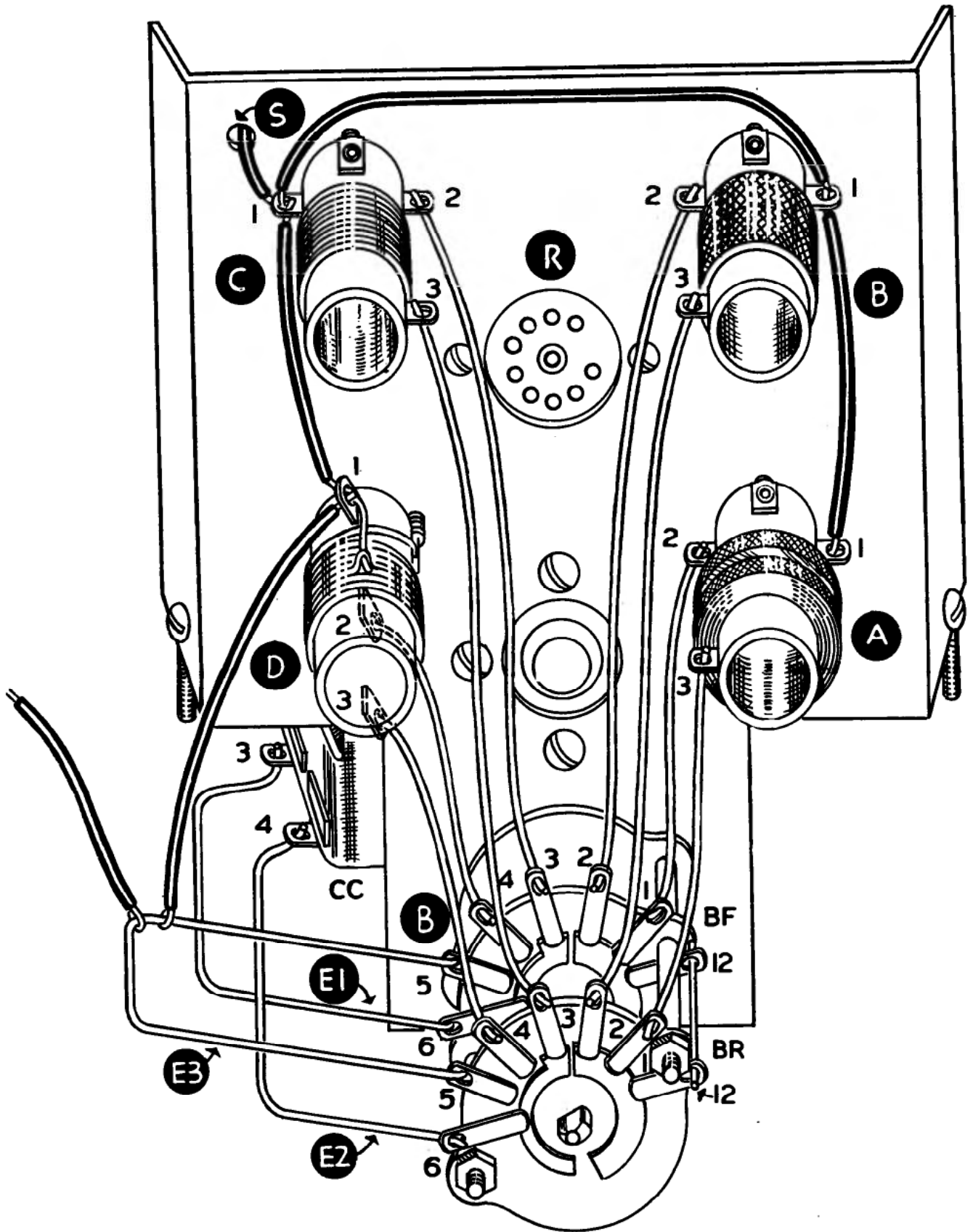

PICTORIAL 1

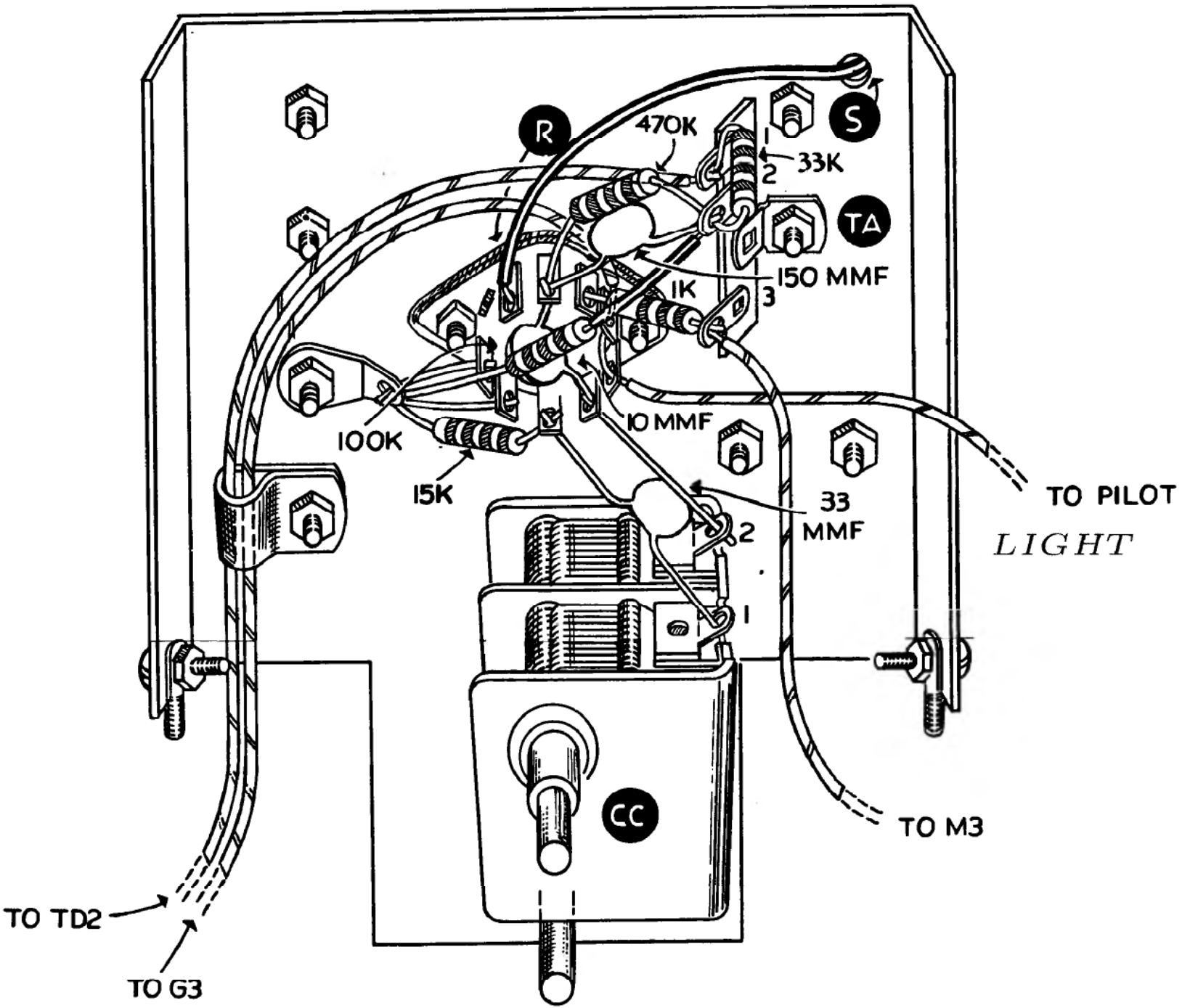

PICTORIAL 2

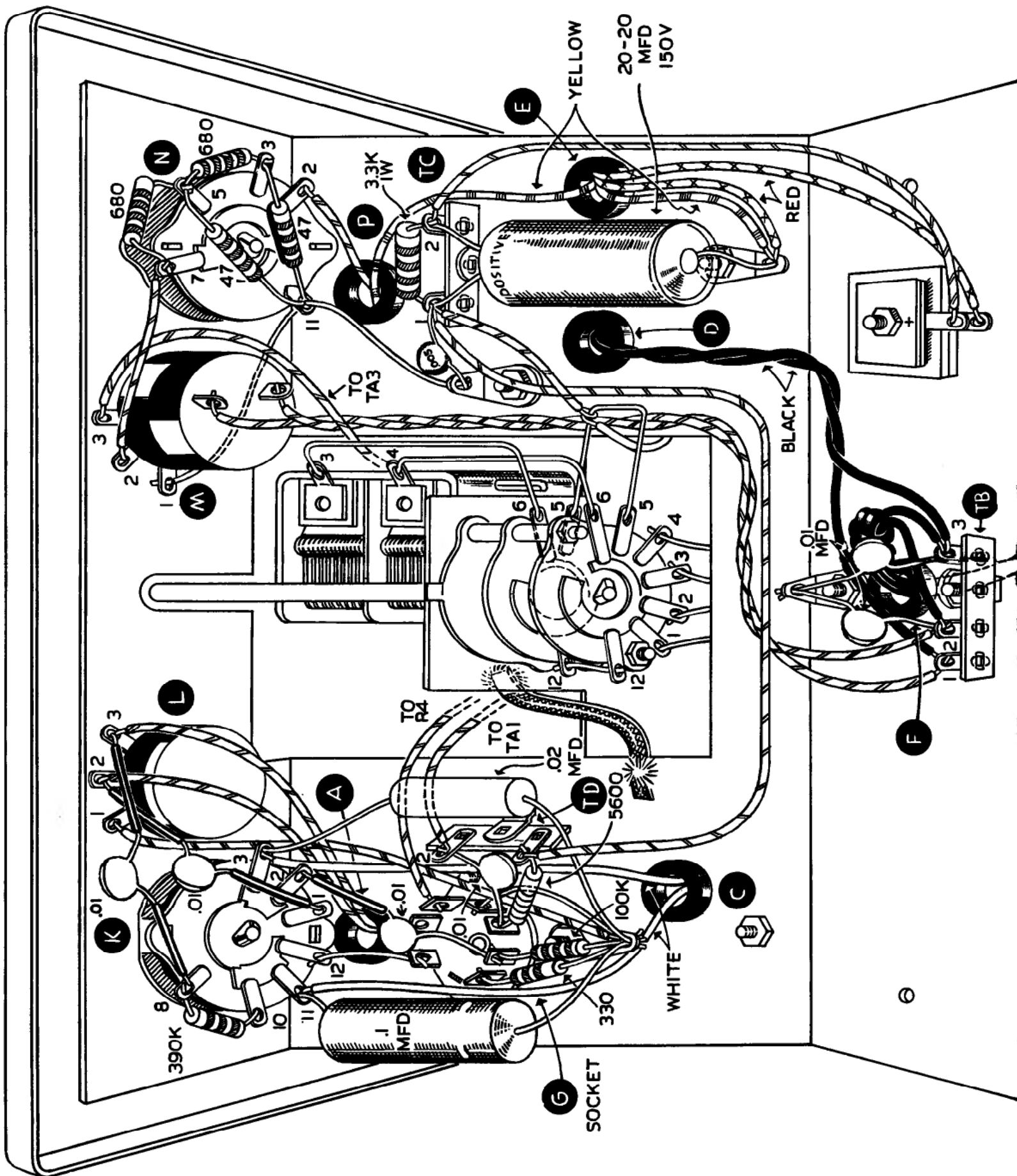

PICTORIAL 3

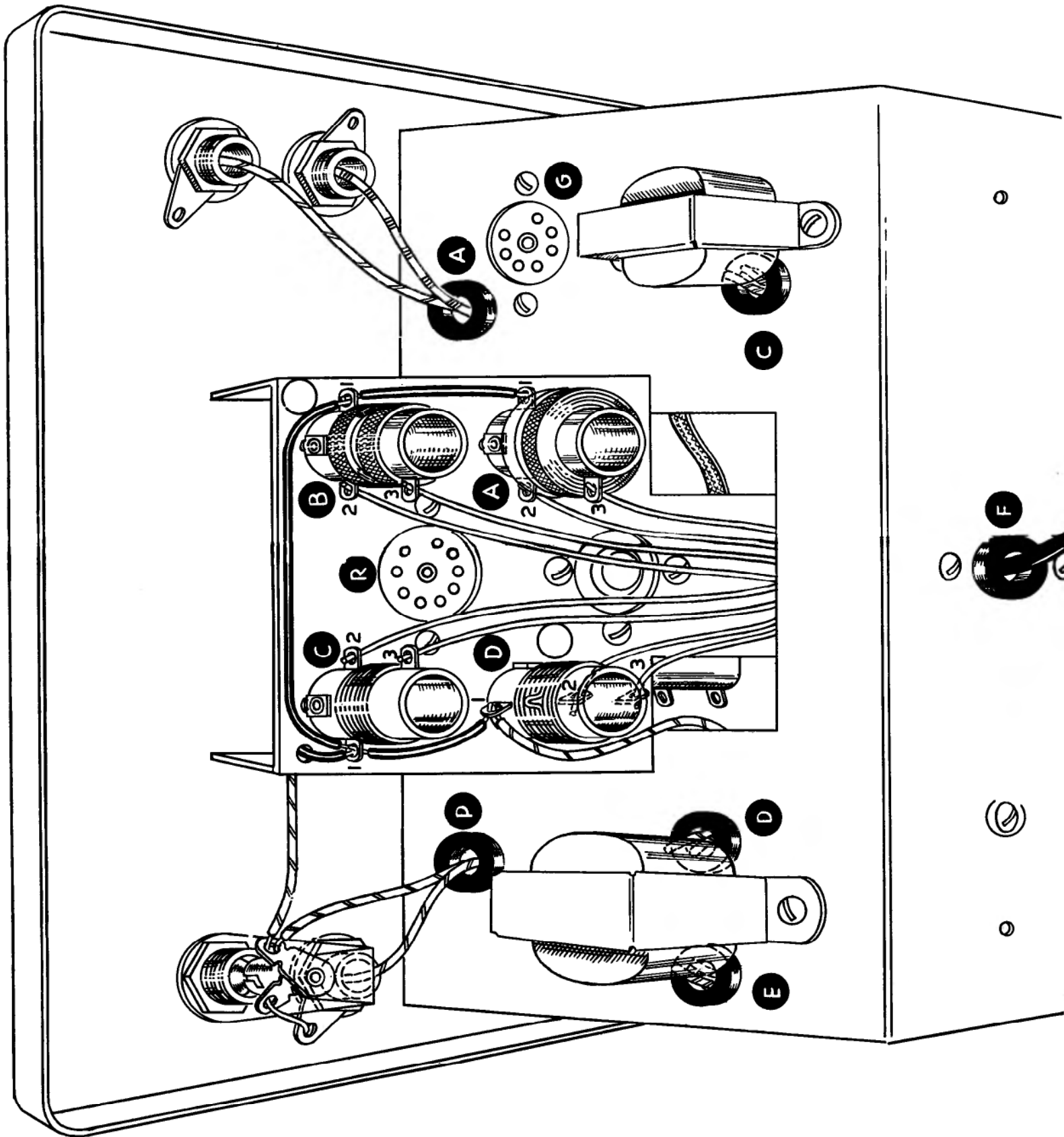

PICTORIAL 4

HELPFUL KIT BUILDING INFORMATION

Before attempting actual kit construction read the construction manual through thoroughly to familiarize yourself with the general procedure. Note the relative location of pictorials and pictorial inserts in respect to the progress of the assembly procedure outlined.

This information is offered primarily for the convenience of novice kit builders and will be of definite assistance to those lacking thorough knowledge of good construction practices. Even the advanced electronics enthusiast may benefit by a brief review of this material before proceeding with kit construction. In the majority of cases, failure to observe basic instruction fundamentals is responsible for inability to obtain desired level of performance.

RECOMMENDED TOOLS

The successful construction of Heathkits does not require the use of specialized equipment and only basic tools are required. A good quality electric soldering iron is essential. The preferred size would be a 100 watt iron with a small tip. The use of long nose pliers and diagonal or side cutting pliers is recommended. A small screw driver will prove adequate and several additional assorted screw drivers will be helpful. Be sure to obtain a good supply of rosin core type radio solder. Never use separate fluxes, paste or acid solder in electronic work.

ASSEMBLY

In the actual mechanical assembly of components to the chassis and panel, it is important that the procedure shown in the manual be carefully followed. Make sure that tube sockets are properly mounted in respect to keyway or pin numbering location. The same applies to transformer mountings so that the correct transformer color coded wires will be available at the proper chassis opening.

Make it a standard practice to use lock washers under all 6-32 and 8-32 nuts. The only exception being in the use of solder lugs—the necessary locking feature is already incorporated in the design of the solder lugs. A control lock washer should always be used between the control and the chassis to prevent undesirable rotation in the panel. To improve instrument appearance and to prevent possible panel marring use a control flat nickel washer under each control nut.

When installing binding posts that require the use of fiber insulating washers, it is good practice to slip the shoulder washer over the binding post mounting stud before installing the mounting stud in the panel hole provided. Next, install a flat fiber washer and a solder lug under the mounting nut. Be sure that the shoulder washer is properly centered in the panel to prevent possible shorting of the binding post.

WIRING

When following wiring procedure make the leads as short and direct as possible. In filament wiring requiring the use of a twisted pair of wires allow sufficient slack in the wiring that will permit the twisted pair to be pushed against the chassis as closely as possible thereby affording relative isolation from adjacent parts and wiring.

















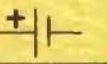



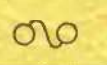

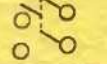

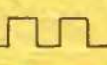

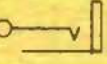

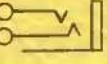
When removing insulation from the end of hookup wire, it is seldom necessary to expose more than a quarter inch of the wire. Excessive insulation removal may cause a short circuit condition in respect to nearby wiring or terminals. In some instances, transformer leads of solid copper will have a brown baked enamel coating. After the transformer leads have been trimmed to a suitable length, it is necessary to scrape the enamel coating in order to expose the bright copper wire before making a terminal or soldered connection.

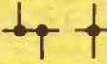
In mounting parts such as resistors or condensers, trim off all excess lead lengths so that the parts may be installed in a direct point-to-point manner. When necessary use spaghetti or insulated sleeving over exposed wires that might short to nearby wiring.

It is urgently recommended that the wiring dress and parts layout as shown in the construction manual be faithfully followed. In every instance, the desirability of this arrangement was carefully determined through the construction of a series of laboratory models.

SOLDERING

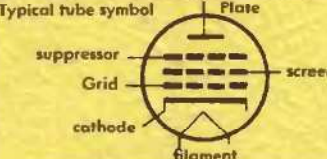
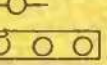
Much of the performance of the kit instrument, particularly in respect to accuracy and stability, depends upon the degree of workmanship used in making soldered connections. Proper soldered connections are not at all difficult to make but it would be advisable to observe a few precautions. First of all before a connection is to be soldered, the connection itself should be clean and mechanically strong. Do not depend on solder alone to hold a connection together. The tip of the soldering iron should be bright, clean and free of excess solder. Use enough heat to thoroughly flow the solder smoothly into the joint. Avoid excessive use of solder and do not allow a flux flooding condition to occur which could conceivably cause a leakage path between adjacent terminals on switch assemblies and tube sockets. This is particularly important in instruments such as the VTVM, oscilloscope and generator kits. Excessive heat will also burn or damage the insulating material used in the manufacture of switch assemblies. Be sure to use only good quality rosin core radio type solder.

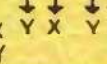
Antenna General		Resistor General		Neon Bulb		Receptacle two-conductor	
Loop		Resistor Tapped		Illuminating Lamp		Battery	
Ground		Resistor Variable		Switch Single pole Single throw		Fuse	
Inductor General		Potentiometer		Switch double pole single throw		Piezoelectric Crystal	
Air core Transformer General		Thermistor		Switch Triple pole Double throw		1000 = K	
Adjustable Powdered Iron Core		Jack two conductor		Switch Multipoint or Rotary		1,000,000 = M	
Magnetic Core Variable Coupling		Jack three conductor		Speaker		OHM = Ω	
Iron Core Transformer		Wires connected		Rectifier		Microfarad = MF	
Capacitor General		Wires Crossing but not connected		Microphone		Micro Microfarad = MMF	
Capacitor Electrolytic		A. Ammeter V. Voltmeter		Typical tube symbol 	Binding post		
Capacitor Variable		G. Galvanometer MA. Milliammeter uA. Microammeter, etc.			Terminal strip		
					Wiring between like letters is understood	$\begin{matrix} \downarrow & \downarrow & \downarrow \\ \rightarrow & X & Y & X \\ \rightarrow & Y & & \end{matrix}$	

HEATH COMPANY

A Subsidiary of Daystrom Inc.

THE WORLD'S FINEST ELECTRONIC EQUIPMENT IN KIT FORM

BENTON HARBOR, MICHIGAN