

**ASSEMBLING
AND USING
YOUR**

Heathkit

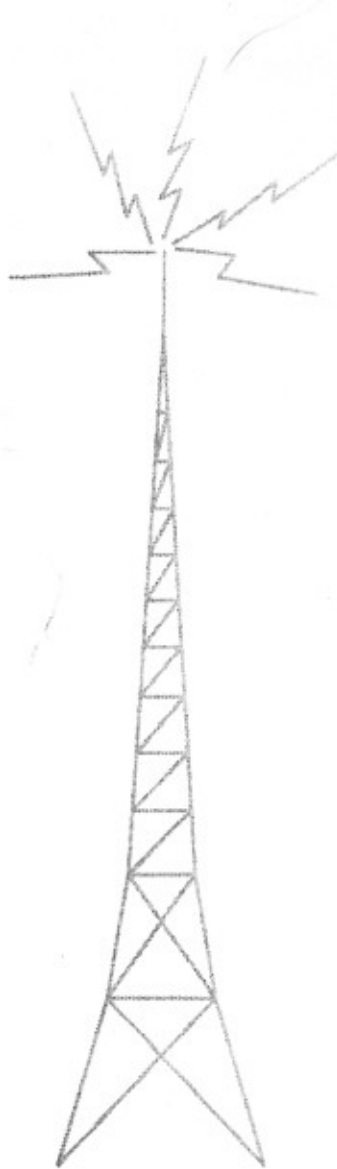

**AUDIO
GENERATOR
MODEL AG-8**

595-42

**HEATH COMPANY
BENTON HARBOR, MICHIGAN**

The World's Finest Test Equipment In Kit Form

ASSEMBLY AND OPERATION OF THE HEATHKIT AUDIO GENERATOR

MODEL AG-8

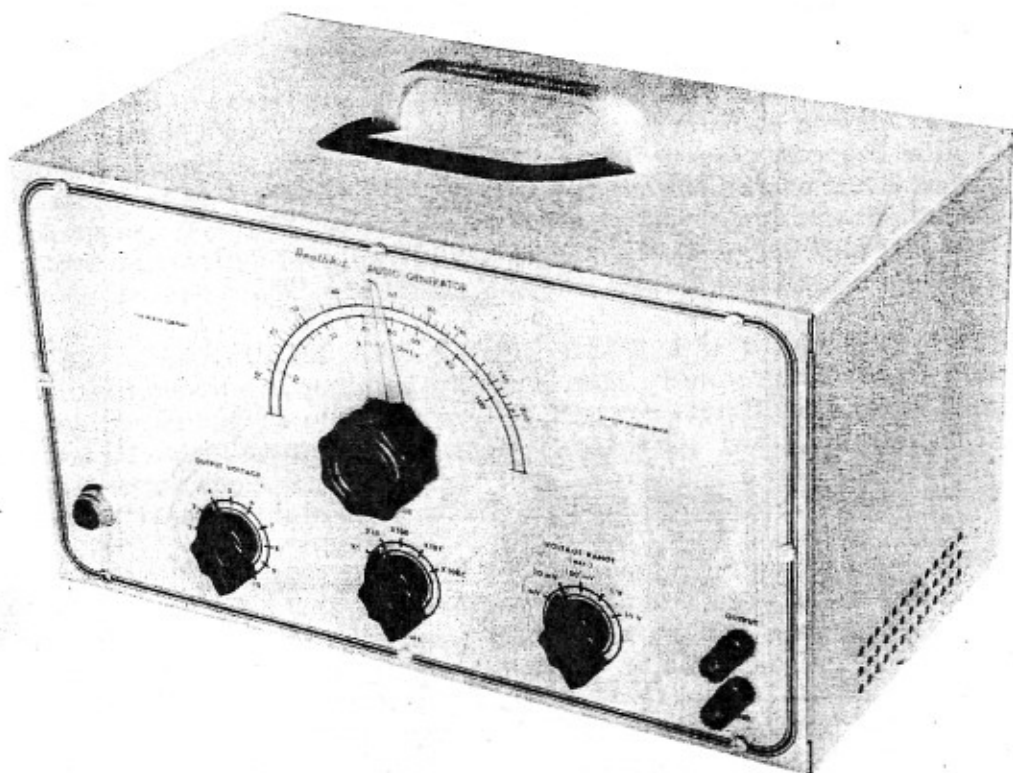

SPECIFICATIONS

Frequency range	20 cps to 1 mc in five ranges
Output voltage	10 volts (no load) plus or minus 1 db 20 cps to 400 kc; down 3 db at 600 kc; down 8 db at 1 mc.
Generator impedance	600 ohms
Distortion	less than 0.4%, 100 cps through audible range
Power requirements	30 watts, 105-125 volts 50-60 cycles AC
Dimensions	7½" high, 13¼" wide, 7½" deep
Shipping weight	15 lbs.

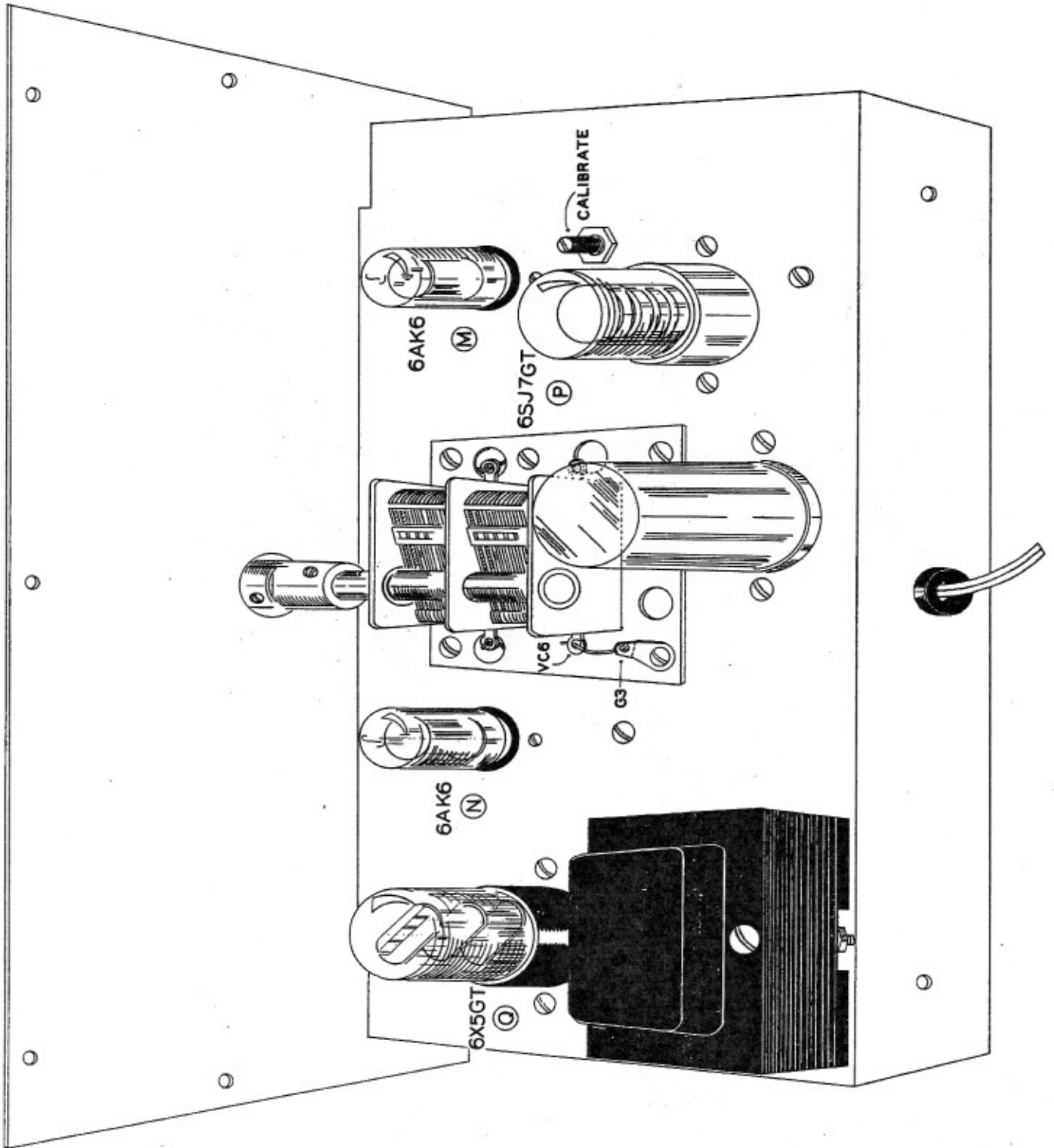

NOTES ON ASSEMBLY AND WIRING OF THE HEATHKIT MODEL AG-8 AUDIO GENERATOR

The Heathkit model AG-8 Audio Generator, when properly constructed, will offer to the owner a laboratory type of instrument capable of years of satisfactory service. We therefore urge you to take the necessary time to assemble, wire, and adjust the instrument carefully. Do not hurry the work, and you will be rewarded with a greater sense of confidence, both in the equipment and your own workmanship.

This manual is supplied to assist you in every way to complete the instrument with the least possible chance for error. We suggest that you take a few minutes now and read the entire manual through before any work is started. This will enable you to proceed with the work much faster when construction is started. The large fold-in pictorials are handy to attach to the wall above your work space. Their use will greatly simplify the completion of the kit. These diagrams are repeated in smaller form within the manual. We suggest that you retain the manual in your files for future reference, both in the use of the AG-8 and for its maintenance.

UNPACK THE KIT CAREFULLY AND CHECK EACH PART AGAINST THE PARTS LIST. In so doing, you will become acquainted with each part. Refer to the charts and other information shown on the inside covers of the manual to help you identify any parts about which there may be a question. If some shortage is found in checking the parts, please notify us promptly and return the inspection slip with your letter to us. Hardware items are counted by weight, and if a few are missing, please obtain them locally if at all possible.

Read the note on soldering on the inside of the back cover. Crimp all leads tightly to the terminal before soldering. Be sure both the lead and the terminal are clean of wax, corrosion, or other foreign substances. Use only the best rosin core solder, preferably one containing the new activated fluxes such as Kester "Resin-Five," Ersin "Multi-core," or similar types.

NOTE: ALL GUARANTEES ARE VOIDED AND WE WILL NOT REPAIR OR SERVICE INSTRUMENTS IN WHICH ACID CORE SOLDER OR PASTE FLUXES HAVE BEEN USED. When in doubt about solder, it is recommended that a new roll be purchased, of the types described above, or plainly marked "Rosin Core Radio Solder."

Resistors and controls generally have a tolerance rating of plus or minus 20% unless otherwise stated in the parts list. Therefore a 100K ohm resistor may test anywhere from 80K to 120K ohms. (The letter K is commonly used to designate a multiplier of 1000.) Tolerances on condensers are generally even greater. Limits of plus 100% and minus 50% are common for electrolytic condensers. The parts furnished with your Heathkit have been specified so as to not adversely affect the operation of the finished instrument.

In order to expedite delivery to you, we are occasionally forced to make minor substitutions of parts. Such substitutions are carefully checked before they are approved, and the parts supplied will work satisfactorily. By checking the parts list for resistors, for example, you may find that a 2.2 megohm resistor has been supplied in place of a 2 megohm as shown in the parts list. These changes are self-evident and are mentioned here only to prevent confusion to you in checking the contents of your kit.

We urge strongly that you follow the wiring and parts layout shown in this manual. The position of wires and parts is quite critical in this instrument, and changes may seriously affect the calibration or distortion levels in the completed equipment.

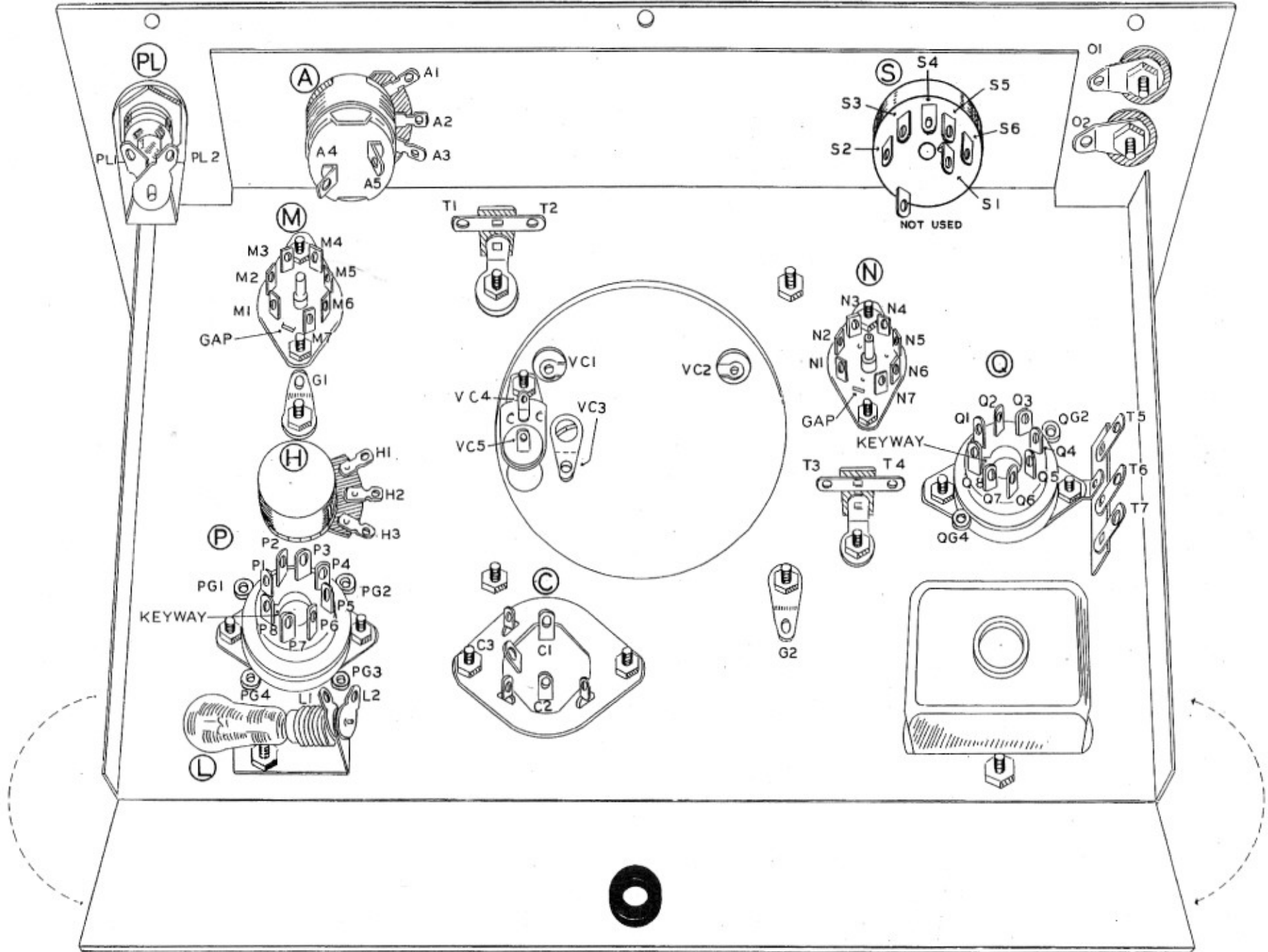

PICTORIAL B
Terminal Designators

STEP BY STEP ASSEMBLY INSTRUCTIONS

BE SURE TO READ THE ENTIRE ASSEMBLY INSTRUCTIONS BEFORE YOU START.

A space has been provided in front of each step so that you can check off each operation as it is completed. This method will prevent confusion if your work is interrupted.

CAUTION: The two-gang variable condenser should be kept fully meshed at all times until the instrument is completed and in its cabinet. Any distortion of the plates of the condenser may seriously affect the calibration of the generator, or render it inoperative.

- () 1. Start by mounting the two miniature tube sockets, M, and N. Position the gap between socket contacts as shown in Pictorial B. Note that the contacts are numbered clockwise starting from this gap and viewed from the bottom. Use the 3-48 machine screws and nuts for mounting these sockets.
- () 2. Mount the two octal tube sockets P and Q next, using 6-32 screws, nuts, and lockwashers. Again, position the keyways as shown in Pictorial B. Note that these contacts are also numbered clockwise starting from the keyway. Mount terminal strip T5-T6-T7 on the outside screw, holding socket Q.
- () 3. Install the condenser mounting wafer at C using 6-32 hardware. Observe the insulating board at the base end of the filter condenser. This board has been punched with identifying cutouts adjacent to each terminal; a semi-circle, a square, and a triangle. Insert the four lugs on the condenser case through the slots in the metal wafer, with the terminals in the right position. Using long nose pliers, twist each of the four case lugs about one-eighth turn, securing the condenser firmly to the wafer. See Figure 1.

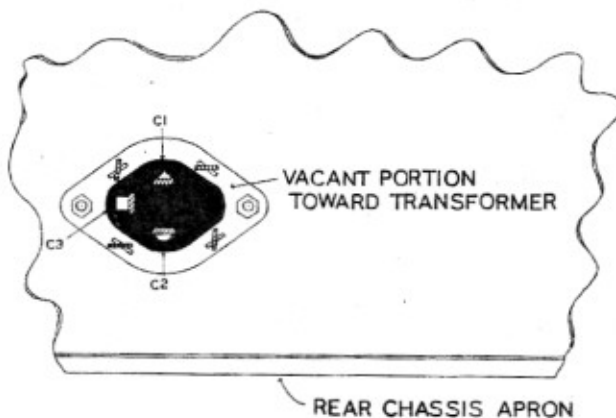

Fig. 1

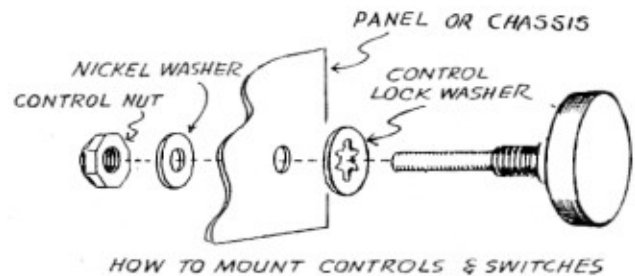

Fig. 2

- () 4. Next add the power transformer to the chassis. Use the 8-32 nuts and lockwashers, but tighten the nuts carefully so that the case is not distorted.
- () 5. Position the 5K control, H, as shown. Use a lockwasher between chassis and the control bushing as shown in Figure 2. Use no nickel washer for this control.
- () 6. Mount the screw-base lamp socket, L, using 6-32 hardware. Do not confuse this with pilot light socket, with a bayonet-base socket. Install the 3 watt 120 volt lamp.
- () 7. Add the single lug terminal strip, T3-T4. Then mount the ground terminal, G1. Use 6-32 hardware for both parts.

- () 8. Lay the chassis aside temporarily and assemble the variable condenser sub-assembly. Position the insulator plate as shown in Figure 3. Mount the condenser to the plate using 6-32 hardware. Don't forget the solder lug used under one of the screws. Then mount the ceramic trimmer below the plate. Be sure the positioning lug on the trimmer is fully inserted in the small hole before tightening the screw.

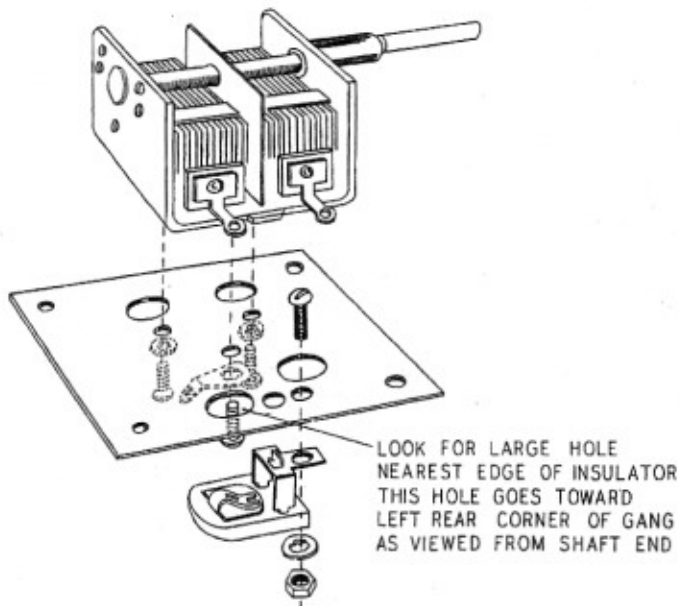

Fig. 3

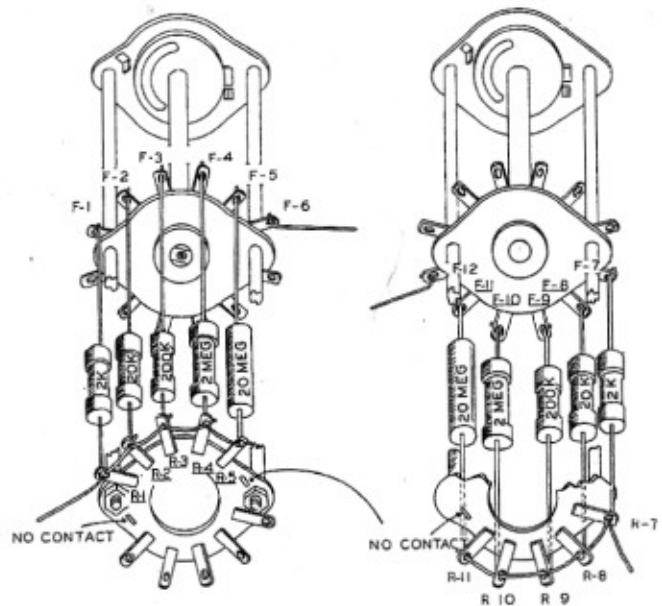
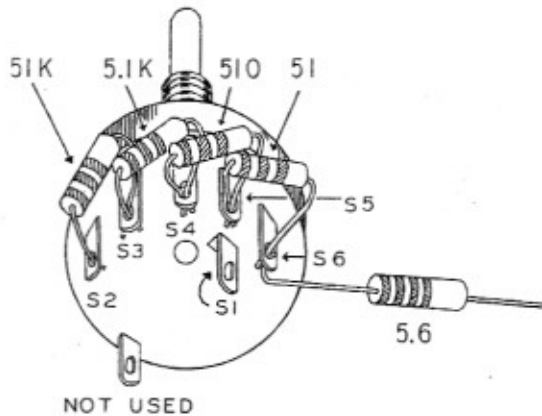

Fig. 4

- () 9. Prepare the range switch as shown in Figure 4. A detailed wiring procedure is given below. All resistors referred to in this step are precision resistors. They have no color coding bands, but have the value stamped on the body. As each resistor is added, firmly crimp its leads to the terminals. **DO NOT SOLDER ANY CONNECTIONS UNTIL THE SWITCH SUB-ASSEMBLY IS COMPLETED AND CAREFULLY CHECKED.**
- () 9a Pass one lead of a 2K ohm resistor all the way through R1. Cut the other lead of this resistor so that it can be easily pushed through F1. Position the resistor body centrally between the two wafers with the resistance value in a readable position. Crimp the cut lead at F1. Cut off the other lead, leaving enough wire to crimp securely at R1. Crimp at R1.
- () 9b In similar fashion, connect a 20K ohm resistor from F2 to R2.
- () 9c Connect a 200K ohm resistor from F3 to R3.
- () 9d Connect a 2 megohm resistor from F4 to R4.
- () 9e Connect a 20 megohm resistor from F5 to R5.
- () 9f Connect one end of a 3" length of bare wire to F6. Note that there is no terminal at R6.
- () 9g Connect a 2K ohm resistor from F7 to R7.
- () 9h Connect a 20K ohm resistor from F8 to R8.
- () 9i Connect a 200K ohm resistor from F9 to R9.
- () 9j Connect a 2 megohm resistor from F10 to R10.
- () 9k Connect a 20 megohm resistor from F11 to R11.
- () 9l Connect one end of a 3" length of bare wire to F12. Note that there is no terminal at R12.
- () 9m Wrap one end of a 9" length of wire around R5, jump to R4 and wrap, then to R3 and wrap and continue until R1, R2, R3, R4 and R5 are wired together. Leave the extra wire attached to R1 for later use.
- () 9n Similarly, wire together R7, R8, R9, R10, R11, leaving the extra wire attached at R7 for later use.

Carefully recheck the switch assembly against Figure 4. When satisfied that the wiring is correct, solder each connection. Lay aside the completed switch assembly temporarily.

- () 10. Prepare the voltage range switch. Refer to Figure 5. The resistors used in the attenuator are held to 5% tolerance and may be identified by the gold colored fourth band.
- () 10a Connect a 51K resistor from S2 to S3. Do not solder S2.
- () 10b Connect a 5.1K resistor from S3 to S4. Solder S3.
- () 10c Connect a 510 ohm resistor from S4 to S5. Solder S4.
- () 10d Connect a 51 ohm resistor from S4 to S5. Solder S4.
- () 10e Cut one lead of the 5.6 ohm resistor to about $\frac{3}{4}$ " long. Connect the short lead to S6. Solder S6.



ALL RESISTORS ON SWITCH
HAVE GOLD FOURTH BAND.

Fig. 5

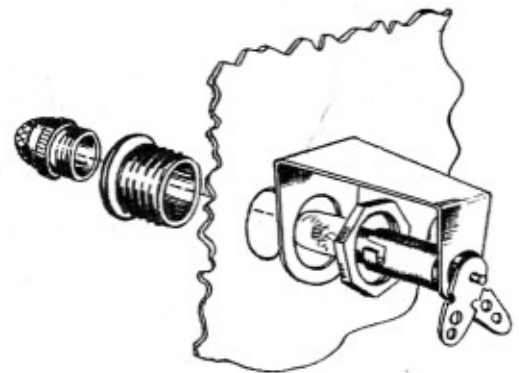

Fig. 6

- () 11. Place the chassis in normal position. Add the variable condenser sub-assembly to the chassis, being careful not to break the ceramic trimmer as it goes through the large circular hole in the chassis.
- () 12. Align the condenser insulator plate with the chassis holes. Install a 6-32 screw through the hole nearest the tube socket P. Add a lockwasher and nut under the chassis, but do not tighten the nut. Similarly, install the diagonally opposite mounting screw.
- () 13. Place a #6 solder lug on a 6-32 screw. Insert the screw through the hole nearest the power transformer. Put another #6 lug on the screw under the chassis, add the nut but do not tighten.
- () 14. Add the remaining screw, using it to mount terminal strip T1-T2 below the chassis.

DO NOT TIGHTEN THESE FOUR SCREWS UNTIL AFTER THE PANEL IS MOUNTED.

- () 15. The pilot light assembly should now be mounted on the panel. Follow Figure 6. The bracket on the assembly should be toward the top of the panel.
- () 16. Add the binding posts to the panel, following Figure 7 carefully. The upper post, or "hot" terminal must be insulated from the panel as shown. The fiber washer on the front of the ground post is used only as a spacer.
- () 17. The panel may now be assembled to the chassis. Stand the chassis on its rear apron. Lay the panel on the front apron and align the holes. Insert the 100K ohm voltage output control, with a control lockwasher on its bushing, through the left hand hole. Add a flat nickel washer and nut, but do not tighten. (See Fig. 2)

- () 18. In similar fashion, mount the voltage range switch sub-assembly in the right hand hole.
- () 19. Mount the range switch sub-assembly in the center hole. Either group of resistors may be nearer the chassis, since both sides are identical.
- () 20. Securely tighten the nuts holding the three controls.
- () 21. Place the chassis in normal position. As shown in Figure 8, assemble the transparent pointer to the insulated coupling. Tighten the set screw in the pointer with care so as not to deform the coupling. This would cause binding and interfere with smooth operation of the vernier drive. Slip the coupling and pointer over the condenser shaft. Shift the condenser insulator plate slightly as required to center the pointer bushing in the panel clearance hole. Then securely tighten the four 6-32 screws holding the condenser plate to the chassis.
- () 22. Rotate the variable condenser shaft to completely mesh the plates. Set the pointer so that it coincides with the extreme counterclockwise calibration mark on the panel scale. Tighten the set screw in the coupling, securing it to the condenser shaft. Mount the fluted knob on the 1/4" insulated condenser shaft.
- () 23. Rotate all the other control shafts to full clockwise position. Attach pointer knobs to each, so that they indicate as follows:

Output Voltage	10
Range	X10KC
Output Range	10 V.

The chassis is now ready for wiring.

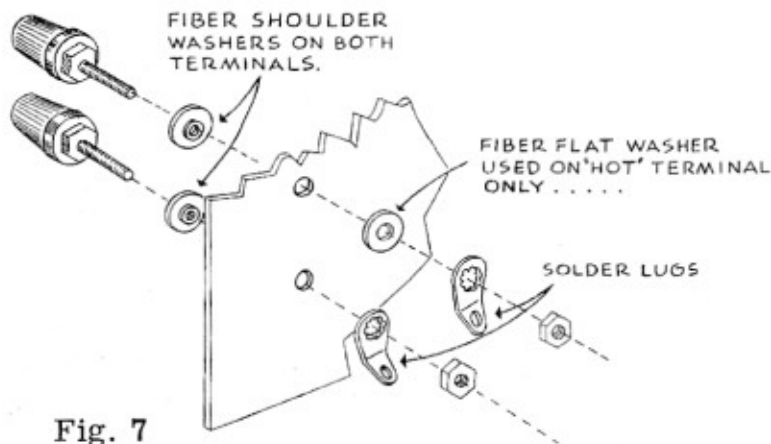

Fig. 7

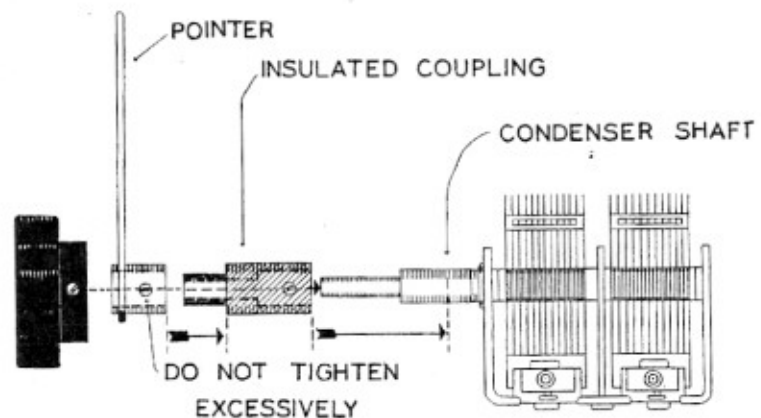

Fig. 8

STEP BY STEP WIRING INSTRUCTIONS

Please refer to Pictorial 2. Note that each terminal on the chassis bears a code designation, for example: the 6X5GT tube socket has been marked socket Q and each contact, starting at the keyway and proceeding clockwise, has been numbered from 1 to 8.

When the wiring instructions read, "Connect a green lead to Q2," it will be understood that the connection is to be made to contact number 2 on socket Q. Ground lugs on socket mounting rings are designated as QG1, QG2, etc.

In some cases, more than one connection is made to the same terminal. This condition is designated by the abbreviation (NS), meaning that the connection should not be soldered until other leads have been connected. Wherever only one lead is connected to a terminal, or where the last lead has been connected, the joint should be soldered. This is indicated by the abbreviation (S).

Unless otherwise indicated, all wire used is insulated.

We again suggest that you place the large pictorial diagrams on the wall above your work space so that they may be referred to easily as you proceed with the wiring.

- () 24. Begin wiring by twisting together the two green leads coming from the transformer and cutting them long enough to reach contacts Q2 (NS) and the other to Q7 (NS).
- () 25. Twist together two pieces of wire about four inches long. Strip all four ends, and connect one end of one lead to Q2 (S). Connect the adjacent end of the other lead to Q7 (S). Connect the other ends of these two leads to N3 (NS) and N4 (NS).
- () 26. Twist together two pieces of wire about 8 inches long. Strip all four ends and connect one end of one lead to N3 (S). Connect the adjacent end of the other end to N4 (S). Connect the other ends of these two leads to M3 (NS) and M4 (NS).
- () 27. Twist together two pieces of wire about 7 inches long. Strip all four ends and connect one end of one lead to M3 (NS). Connect the adjacent end of the other lead to M4 (NS). Connect the other ends of these two leads to P2 (NS) and P7 (NS).
- () 28. Twist together two pieces of wire about 3 inches long. Strip all four ends and connect one end of one lead to M4 (S). Connect the adjacent end of the other lead to M3 (S). Connect the other ends of these two leads to the pilot light socket at PL1 (S) and PL2 (S).
- () 29. Connect the red and yellow wire from the power transformer to QG4 (S).
- () 30. Run a piece of bare wire from QG2 (S) to the grounded output binding post 01 (NS).
- () 31. Twist together the two red leads coming from the power transformer. Cut them to reach Q3 and Q5. Strip the ends and connect to Q3 (S) and Q5 (S). Similarly, connect the two black leads of the transformer to T5 (NS) and T7 (NS). (On some transformers, of these black leads may be black and red.)
- () 32. Connect one end of the 220 ohm 2 watt resistor to Q8 (S). Connect the other end of Q1 (NS).
- () 33. Connect a wire from Q1 (S) to C2 (\triangle) (NS). Connect a 1K 5 watt resistor between C2 (\triangle) (S) and C1 (\triangle) (NS).
- () 34. Connect a 2.2K resistor between C1 (\triangle) (NS) and C3 (\square) (NS).
- () 35. Connect a wire from C1 (\triangle) (S) to the terminal strip T1 (NS).
- () 36. Connect a wire from C3 (\square) (NS) to M6 (NS).
- () 37. Connect a wire from M6 (S) to N6 (S).
- () 38. Run a short bare wire from PG3 (S) to the lamp socket L2 (S).
- () 39. Connect a 56K resistor from C3 (\square) (NS) to P6 (NS). Connect another 56K resistor from P6 (S) to PG2 (S).
- () 40. Connect another 56K resistor from C3 (\square) (S) to P8 (use sleeving) (NS).

NOTE: Wherever the term "use sleeving" appears, it is desirable to cover the exposed lead of the component with insulating sleeving, or "spaghetti," to prevent accidental shorting of the lead to other parts.

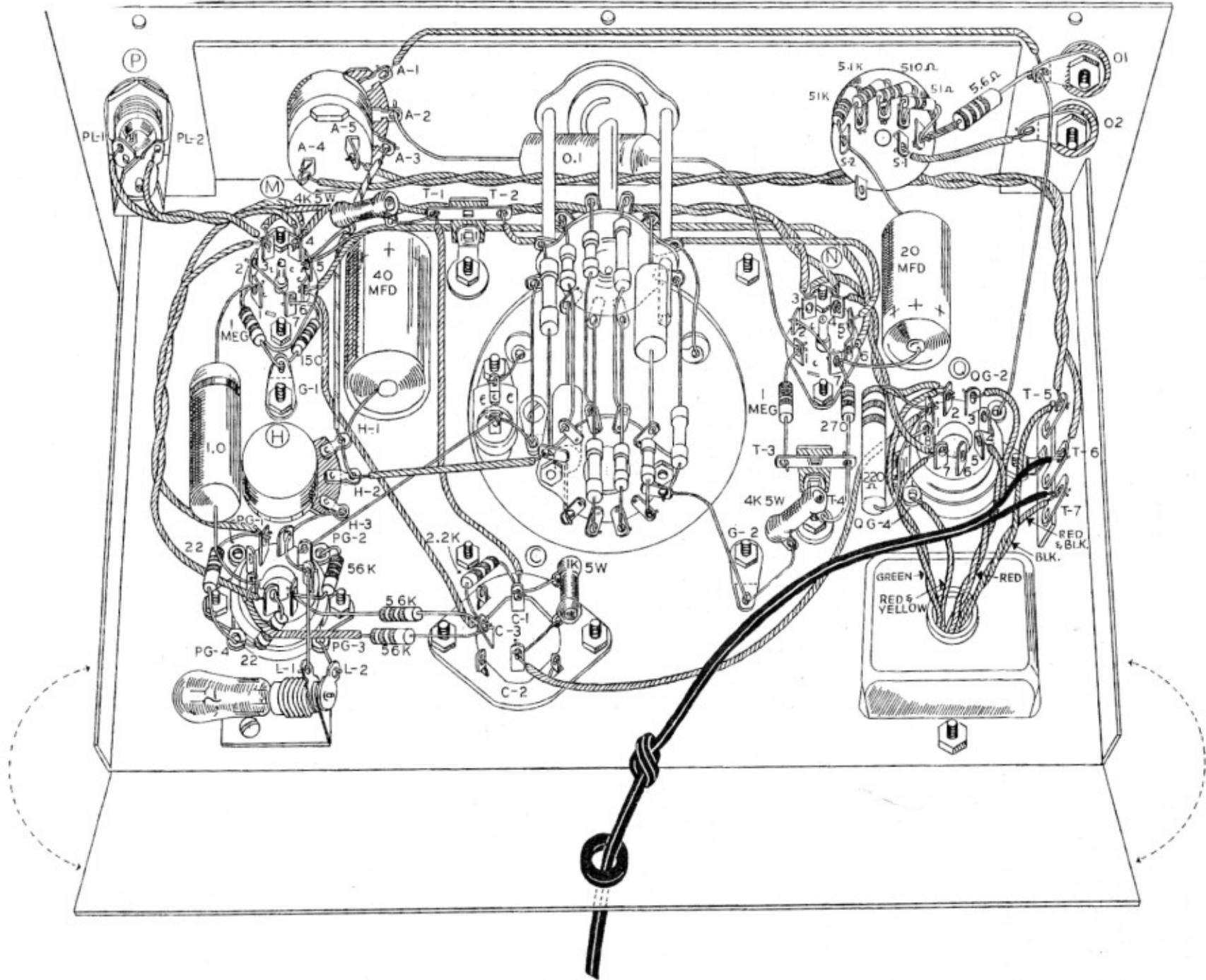

PICTORIAL C
Wiring Diagram

- () 41. Connect a bare wire from the lamp socket L1 (S) to P5 (NS).
- () 42. Connect a bare wire from P5 (S) through P3 (NS) to the 5K control terminal H3 (S). Then solder P3.
- () 43. Connect a 22 ohm resistor from P2 (use sleeving) (S) to PG4 (NS). Connect another 22 ohm resistor from P7 (S) to PG4 (S).
- () 44. Run a short piece of bare wire from P1 (S) to PG1 (S).
- () 45. Run a piece of bare wire from P4 (S) through the ceramic trimmer terminal VC5 (NS) to VC3 (NS). Solder VC5.
- () 46. Connect either end of a 0.1 mfd condenser to P8 (use sleeving) (S). Connect the other end to M1 (NS).
- () 47. Connect a 1 megohm resistor from M1 (S) to ground terminal G1 (NS).
- () 48. Slide one lead of a 150 ohm resistor through M7 (NS) to M2 (S). Connect the other end of the resistor to G1 (S). Then solder M7.
- () 49. Twist together two pieces of wire about 13 inches long. Strip all four ends and connect one end of one wire to the switch on the output control at A4 (S). Connect the adjacent end of the other wire to A5 (S). Connect the other ends of these two leads to T5 (S) and T6 (NS).
- () 50. Connect a 4K 5 watt resistor between T1 (S) and M5 (NS).
- () 51. Connect the positive end (+) of the 40 mfd 150 volt condenser to M5 (S). Connect the other end to H1 (NS). Connect the lead from range switch R1 (use sleeving) through H2 (NS) to H1 (NS). Now solder H2.
- () 52. Run a wire from H1 (S) to the output control terminal A3 (S).
- () 53. Run a wire from T2 (S) to N5 (S).
- () 54. Connect either end of a 0.1 mfd. condenser to A2 (S). Connect the other end to N1 (NS).
- () 55. Connect a 1 megohm resistor between N1 (S) and the terminal strip T3 (S).
- () 56. Run a wire from A1 (S) to 01 (NS). Run a wire from the Voltage Range switch terminal S1 (S) to the insulating binding post 02 (S).
- () 57. Connect the free end of the 5.6 ohm resistor on the voltage range switch to the grounded binding post 01 (S).
- () 58. Slide the positive (+) lead of the 20 mfd. 150 volt condenser through N7 (NS) and connect to N2 (S). Connect the other lead of the condenser to S2 on the voltage range switch (S).
- () 59. Connect a 4K 5 watt resistor between T4 (NS) and G2 (NS). Connect the lead from range switch terminal R7 to G2 (S). Connect a 270 ohm resistor between N7 (S) and T4 (S).
- () 60. Connect the lead from range switch terminal F12 to VC3 (S). Connect a bare wire from VC1 (S) to VC4 (S). Connect the lead from range switch terminal F6 to VC2 (S).
- () 61. Install the 3/8" grommet in the hole in rear apron of chassis. Insert stripped end of the line cord through the hole. Tie a knot in the line cord at a point leaving sufficient length with slack to reach to the terminal strip T5-T6-T7. Connect the line cord to T6 (S) and T7 (S).
- () 62. Above the chassis, connect a short bare wire between VC6 and G3 (S). See Pict. 1.

This completes the wiring of the instrument. Before applying power, carefully recheck each step in the wiring. Dress all leads so that there are no shorts between bare leads and other components or terminals. Remove all loose solder and wire clippings from the chassis. Rotate the output voltage control full counterclockwise to "Off."

With the chassis in normal position, connect the line cord to a 105-125 volt 50-60 cycle source.

CAUTION: DO NOT CONNECT THIS INSTRUMENT TO A D-C OR 25 CYCLE LINE. TO DO SO MAY SERIOUSLY DAMAGE THE POWER TRANSFORMER.

Turn the output voltage control clockwise, applying power to the instrument. The pilot light and all tube filaments should light. The instrument is now ready for final adjustment and calibration

CALIBRATION PROCEDURE

- () 63. Allow the instrument to warm up for at least fifteen minutes.
- () 64. Connect an A-C voltmeter across the output terminals. The meter should have scale readings of 10 and 30 volts at least, and should preferably be a high-impedance meter. The Heathkit Vacuum Tube Voltmeter or A-C Vacuum Tube Voltmeter is ideal.
- () 65. Set the panel controls as follows:

Output voltage	10
Range	X 10
Voltage range	10 V
Frequency	20

Note: The Heathkit AG-8 Audio Generator has two calibrated scales. The outer scale calibrated from 20 to 200, is used for all settings of the range switch except the "X 10 KC" position. The inner scale, calibrated from 20 to 100, is used for the "X 10 KC" position only.

- () 66. Adjust the "Calibrate" control for exactly 10 volts output as shown on the voltmeter.
- () 67. Set the ceramic trimmer mounted below the variable condenser to mid range. This will be with the slot in the movable plate parallel to the front panel.
- () 68. Set range switch to X 1 and the main dial to 180. Observe that as the dial is rocked through the range from 150 to 200 the output voltage fluctuates, stops, and then fluctuates again. The stationary reading between the two stages of fluctuation indicates zero beat between the output of the generator and the third harmonic of the stray 60 cycle field set up by the power supply of the generator. This condition should obtain at 180 on the main dial. If it does not, adjust the ceramic trimmer slightly with a non-metallic screwdriver to secure calibration.
- () 69. Set the main dial to 60. The same "zero beat" effect should be obtained, with the fluctuations greater in amplitude. This serves as a check on the calibration.
- () 70. Next, switch to the X 10 range. Rotate the main dial through its range and observe the output voltage. It should remain substantially constant through the range. The calibration is now complete and the instrument is ready for installation in its cabinet.
- () 71. Attach the handle to the top of the cabinet, using the 10-24 machine screws. Pull the line cord through the large hole in the back of the cabinet, and mount the panel by using eight #6 sheet metal screws through the panel into the lip of the cabinet. Use two more screws to secure the chassis to the rear of the cabinet. Insert the four rubber feet through the holes in the bottom of the cabinet.

NOTES ON CALIBRATION AND ADJUSTMENT

The Heathkit model AG-8 Audio Generator when adjusted and calibrated as described above will be more than adequate for general laboratory and service applications. Its performance compares very favorably with, and in some instances exceeds the finest and most expensive audio generators available today.

For applications requiring extremely flat output voltage variations over a frequency range, the ceramic trimmer can be adjusted higher or lower in capacity. This variation may slightly disturb the calibration accuracy on the higher ranges, but resetting of the dial pointer will offset these errors.

Other applications may require precise calibration on the high range. At frequencies in the super-sonic range, the operation of any RC oscillator circuit is restricted somewhat in that phase shift conditions cause a lower frequency of operation than theory predicts. For this reason, the fifth band on the AG-8 has been separately calibrated. Calibration on the lower bands is automatically obtained by the use of precision resistors in the range switch. If variations in calibration on the highest range are noted, they may be eliminated by a slight readjustment of the "Calibrate" potentiometer in the feedback circuit.

When making output voltage measurements, bear in mind that most A-C voltmeters have an appreciable frequency error. These errors, depending on the type of instrument, may become apparent at frequencies as low as 10 kc. Unless such errors are known and compensated for, DO NOT attempt to adjust for flat output voltage on the X 100, X1 KC, and X 10 KC ranges.

For more precise calibration checks, the use of a cathode ray oscilloscope and an accurately known reference frequency is indicated. By applying the reference frequency to one pair of plates of the oscilloscope and the output of the audio generator to the other pair, a series of frequency comparisons can be obtained through the use of Lissajous patterns. Such comparisons can be made over wide ranges, and the constructor is referred to the bibliography appearing at the end of this manual for more information on this subject.

PANEL CONTROLS

The output frequency of the AG-8 is determined by reading the main dial and multiplying this reading by the setting of the range switch. Use the outer calibration marks for the X1, X10, X100, and X1 KC ranges. Use the inner calibration marks for the X 10 KC range only.

The output voltage of the AG-8 is determined as follows: the setting of the "Voltage Range" switch represents the maximum voltage output. The setting of the "Output Voltage" control indicates what portion of the maximum is actually being delivered to the load.

For example: Output Voltage 10,	Voltage Range 10 V,	actual output is 10 volts
" 1,	" 10 mV,	" 1 mV.
" 4,	" 100 mV,	" 40 "

APPLICATION

Primary application of an instrument such as the Heathkit AG-8 is in investigation and development of audio circuitry. With the recent interest in wide band amplifier characteristics, the AG-8 fills a serious gap in that it makes available known audio voltages over an extremely wide range of both frequency and amplitude. The distortion inherent in the instrument is so low that for all practical purposes it may be disregarded.

Because the output voltage holds relatively constant over wide ranges in frequency, the AG-8 is ideal for running frequency response curves on audio circuits. Once set by means of the attenuators, this voltage may be relied on to within plus or minus 1 db if the instrument has been properly constructed and adjusted.

CIRCUIT DESCRIPTION

The oscillator section of the Heathkit AG-8 consists of a two-stage resistance coupled amplifier. Both negative and positive feedback are utilized. The positive feedback is applied through a frequency determining RC network. The capacity in this network consists of the variable two-gang condenser. The capacity change so introduced is sufficient to give a tuning range of 10 to 1 in frequency. The resistive components of the frequency determining network are switched in decades by means of the range switch.

Negative feedback from the plate of the second stage is applied to the cathode of the first tube, thus stabilizing the operation of the oscillator section and reducing distortion. The operating level of this feedback circuit is determined by the 5K "Calibrate" control, and so establishes the overall gain of the two stages. A part of the feedback network consists of the 3 watt lamp which operates as a non-linear resistor so as to hold the output voltage of the oscillator at the constant value determined by the calibration control.

The output voltage control on the front panel is essentially a voltage divider across the output of the oscillator, and is used to vary the grip voltage to the output amplifier of the generator. This control is linear and calibrated.

An output power amplifier (6AK6) is used to isolate the oscillator section of the generator from varying load conditions. Input to this tube is established by the "Output Voltage" control on the panel. This is a conventional gain control with linear taper. Panel markings are calibrated linearly from 0 to 10. Power is taken from the amplifier at its cathode, and is applied to the five-decade step attenuator, or "Voltage Range" control. The amplifier operates as a cathode follower, with the advantages of low output impedance and good voltage regulation.

The power supply to the generator is a conventional transformer-rectifier-RC filter system.

IN CASE OF DIFFICULTY

If trouble is experienced in the operation of the instrument, proceed as follows:

1. Check the wiring over carefully again. Sometimes having a second person check the wiring will reveal an error consistently overlooked. Use a colored pencil to check each lead on the pictorial diagram as it is checked through. In this way, none of the connections can be missed.
2. Check the tubes. If you have no tube checker, take them to a radio serviceman for checking.
3. Check the voltages at each tube socket contact against the readings charted below. Readings given were taken with a Heathkit Vacuum Tube Voltmeter, and should hold within plus or minus 20% provided the same general type of voltmeter is used. Use of meters with input resistances other than 11 megohms may cause considerable variations in readings. Readings were taken to chassis, dial at 100, attenuators full on, X10 range, 117 volt line.

Socket	Pin 1	Pin 2	Pin 3	Pin 4	Pin 5	Pin 6	Pin 7	Pin 8
M (6AK6)	NR	4.4 V DC	3.2 V AC	3.2 V AC	92	170	4.4 V DC	-
N (6AK6)	38 V DC	55 V DC	3.2 V AC	3.2 V AC	190 V DC	170	55 V DC	-
P (6SJ7GT)	NR	3.2 V AC	2.5 V DC	NR	2.5 V DC	70 V DC	3.2 V AC	255 V DC
Q (6X5GT)	240 V DC	3.2 V AC	230 V AC	NC	230 V AC	NC	3.2 V AC	250 V DC
NC—No connection				NR—No reading				

4. Should inspection reveal the necessity for replacement of a defective component, please write to the Heath Company immediately and observe the following procedure:

- A. Clearly identify the part in question by using the part number and description found in the manual parts list.
- B. Identify the type and model of kit in which it is used.
- C. Mention the order number and date of kit purchase.
- D. Describe nature of defect.

The Heath Company will promptly supply the necessary replacement and please do not return the defective component until specifically requested to do so. Do not under any circumstances dismantle the component in question as this will void the guarantee. If tubes are to be replaced, please pack them carefully to prevent breakage in shipment.

SERVICE

In event continued operational difficulties of the completed instrument are experienced, may we remind you that the Heath Company has provided a technical consultation service. Every effort

will be made to assist you through correspondence. We emphasize that in all correspondence this instrument should be referred to as the Model AG-8 Audio Generator.

The facilities of the Heath Company Service Department are also available. Your instrument may be returned for inspection, repair, and calibration for a service charge of \$3.00 plus the cost of any additional material that may be required. This service policy applies only to completed instruments constructed in accordance with the instructions as stated in the manual. Instruments that are not completed or instruments that are modified will not be accepted for repair. Instruments showing evidence of acid core solder or paste fluxes will be returned not repaired.

The Heath Company is willing to offer its utmost cooperation to assist you in obtaining proper operation of your instrument. The repair service is available until one year from the date of purchase.

NOTE: Before returning this unit, be sure all parts are securely mounted. Attach a tag to the instrument giving name, address and trouble experienced. Pack in a rugged container, preferably wood, using at least three inches of shredded newspaper or excelsior on all sides. Do not ship in original carton only as this carton is not considered adequate for safe shipment of the completed instrument. Ship by prepaid express, if possible. Return shipment will be made by express collect. Note that a carrier cannot be held liable for damage in transit if packing, in his opinion, is insufficient.

WARRANTY

The Heath Company limits its warranty on any part supplied with any Heathkit (except tubes, meters, and rectifiers where the original manufacturer's guarantee only applies) to the replacement, within three (3) months, of said part, which when returned with prior permission postpaid was, in the judgment of the Heath Company, defective at time of sale.

Prices are subject to change without notice. The Heath Company reserves the right to change the design without incurring liability for equipment previously supplied.

BIBLIOGRAPHY

For additional reading material about Audio Generators and their applications, we suggest the many articles in the popular radio and service magazines, such as:

RADIO AND TELEVISION NEWS (RADIO NEWS)

September	1945	Audio Oscillators and Their Applications
August	1946	Audio Oscillators
November	1946	Low Cost Audio Oscillator
January	1947	R-C Audio Oscillator
June	1950	Audio Oscillator and VTVM
September	1950	Wide Range R-C Oscillator
November	1950	R-C Beat Frequency Oscillator

ELECTRONICS

September	1948	Low Frequency Oscillator
-----------	------	--------------------------

RADIO ELECTRONICS (RADIO CRAFT)

August-Sept.	1947	Bandspread Audio Oscillator
May	1948	Laboratory Type Oscillators
July	1948	Audio Generator
August	1948	Single Control Audio Oscillator
October	1948	Calibrating Audio Oscillators
February	1949	Versatile Audio Oscillator

August	1949	Laboratory Square Wave Generator.
July	1950	Square Wave Analysis.
July	1950	Extended Range Oscillator

An excellent description of the principles of R-C oscillators may be found in the "H.P. Journal," Volume 1 Nos. 3 and 4, November and December 1949, published by the Hewlett-Packard Company, Palo Alto, California, under the title of "Design Notes on the Resistance-Capacity Oscillator Circuit." The Hewlett-Packard name has for years been synonymous with R-C oscillators as they manufacture the greatest variety of the finest equipment of this type.

A comprehensive discussion on the use of Lissajous figures and oscilloscopes to measure frequencies in the audio range is given in the "Encyclopedia on Cathode Ray Oscilloscopes and their Uses," by Rider and Usland (John F. Rider Publisher, Inc., New York). See Chapter 12 of this reference.

**WIRING OF EXPORT TYPE
110/220 VOLT POWER
TRANSFORMERS**

These transformers have a dual primary for use on either 110 Volts or 220 Volts. Wire as shown.

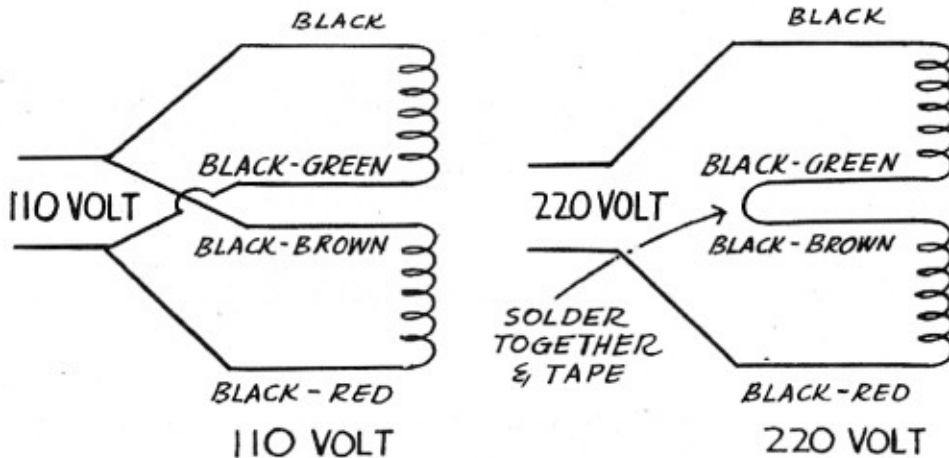

Notes

PARTS LIST

When ordering replacement parts, be sure to specify the part number shown below.

Part No.	Parts per kit	Description	Part No.	Parts per kit	Description
Resistors			Miscellaneous		
1-41A	1	5.6 ohm 1 w. 5% Composition	54-5	1	Power transformer
1-49	2	22 " $\frac{1}{2}$ w. " "	75-5	1	Condenser insulator plate
1-62	1	51 " $\frac{1}{2}$ w. 5% " "	89-1	1	Line cord
1-66	1	150 " $\frac{1}{2}$ w. " "	100-M10	1	Pointer assembly
1-13B	1	220 " 2 w. " "	340-2	1	Length bare wire
1-42	1	270 " $\frac{1}{2}$ w. " "	344-1	1	Length hookup wire
1-63	1	510 " $\frac{1}{2}$ w. 5% " "	346-1	1	Length sleeving
1-44	1	2.2K " $\frac{1}{2}$ w. " "	462-6	1	Fluted knob
1-64	1	5.1K " $\frac{1}{2}$ w. 5% " "	462-M11	3	Pointer knobs
1-65	1	51K " $\frac{1}{2}$ w. 5% " "	453-5	1	Insulated coupling
1-47	3	56K " $\frac{1}{2}$ w. " "	481-1	1	Condenser wafer
1-35	2	1 megohm $\frac{1}{2}$ w. " "	Metal Parts		
2-53	2	2K ohm Precision	200-M33	1	Chassis
2-38	2	20K " " "	203-M38F3	1	Panel
2-54	2	200K " " "	211-1	1	Handle
2-55	2	2 megohm " " "	90-4	1	Cabinet
2-56	2	20 " " " "	Sockets, Terminal Strips		
3-3E	1	1K 5 w. Wire-wound	434-2	2	Octal tube sockets
3-4E	2	4K 5 w. Wire-wound	434-15	2	Miniature tube sockets
Condensers			434-23	1	Lamp socket, candleabra
26-8	1	Two section variable (Frequency)	431-1	2	One lug terminal strip
31-5	1	Ceramic trimmer, 7-35 mmf.	431-4	1	Three lug terminal strip
23-11	2	0.1 mfd. 600 v. Paper	Pilot Light Assembly		
25-19	1	20 mfd. 150 v. Electrolytic	413-1	1	Jewel
25-10	1	20-20-20 mfd. 450 v. Electrolytic	455-1	1	Bushing
25-20	1	40 mfd. 150 v. Electrolytic	434-22	1	Socket
Controls and Switches			252-12	1	Nut
10-19	1	5K Control (Calibrate)	Hardware		
19-11	1	100K Control with switch (Output Voltage)	73-1	1	3/8 Rubber grommet
63-37	1	1 pole 5 position Rotary switch (Voltage Range)	250-2	4	3-48 Machine screws
63-41	1	2 pole 5 position Rotary switch (Range)	250-8	10	#6 Sheet metal screws
Tubes and Lamps			250-15	2	#8 Set screws
411-13	1	6SJ7GT Tube	250-9	17	6-32 Machine screws
411-17	1	6X5GT Tube	250-19	2	Handle screws
411-42	2	6AK6 Tubes	250-22	3	Knob set screws
412-1	1	#47 Panel lamp	252-1	4	3-48 Hex nuts
412-2	1	120 v. 3 w. Lamp	252-3	15	6-32 Hex nuts
Binding Post Assembly			252-4	2	8-32 Hex nuts
100-M16	2	Cap assemblies	252-7	4	Control nuts
427-2	2	Base	253-1	1	Flat fiber washer
			253-2	2	Shoulder fiber washer
			253-10	3	Flat washer, control
			254-1	13	#6 Lockwasher
			254-2	2	#8 Lockwasher
			254-4	4	Control lockwasher
			259-1	6	#6 Solder lugs
			261-1	4	Rubber feet

