

Assembly
and
Operation
of the

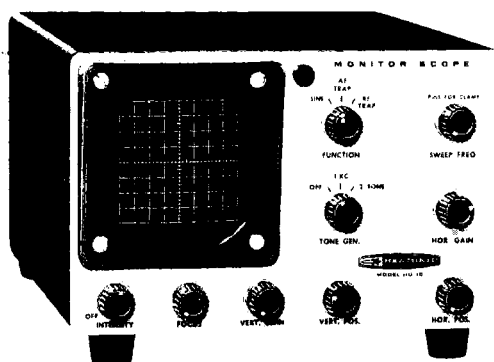

MONITOR
SCOPE

MODEL HO-10



CONDENSED
MANUAL

HEATH COMPANY,
BENTON HARBOR,
MICHIGAN

Copyright © 1962
Heath Company
All rights reserved

595-578



SPECIFICATIONS

VERTICAL AMPLIFIER

Frequency Response. ±3 db from 10 cps to 500 kc.
 Sensitivity. 500 mv per inch deflection.
 Input Resistance. 50 KΩ.

HORIZONTAL AMPLIFIER

Frequency Response. ±3 db from 3 cps to 30 kc.
 Sensitivity. 800 mv per inch deflection.
 Input Resistance. 1 megohm.

SWEEP GENERATOR

Recurrent Type. Linear sawtooth produced by internal sweep generator.
 Frequency. 15 to 200 cps (variable).

TONE OSCILLATORS

Frequencies. Approximately 1000 cps and 1700 cps.
 Output Voltage. 15 mv (nominal).

GENERAL

Frequency Coverage. 160 through 6 meters (50-75 Ω coaxial input).
 Power Limits (At rear coaxial connector). 5 watts to 1 kilowatt output.
 Tube And Diode Complement.
 1 - 3RP1 CRT, medium persistence, green trace.
 1 - 6BN8 Clamper, low level RF detector.
 1 - 6C10 Sweep generator, horizontal amplifier.
 1 - 6J11 Twin phase shift tone generator.
 1 - 12AU7 Vertical amplifier.
 1 - 1V2 High voltage rectifier.
 4 - Silicon diodes, B+ rectifiers.

Front Panel Controls.	FUNCTION Selector. SWEEP FREQ. TONE GEN. HOR GAIN. HOR POS. VERT POS. VERT GAIN. FOCUS. INTENSITY/OFF.
Rear Control.	XMTR ATTEN. Attenuates 0 to 24 db at approximately 6 db per step.
Power Supply.	Transformer operated, fused at 1/2 ampere.
Power Requirements.	105-125 VAC, 50/60 cps, 35 watts.
Dimensions.	5-1/4" high x 7-3/8" wide x 11" deep (including knobs).
Net Weight.	8-1/4 lbs.
Shipping Weight.	10 lbs.

INTRODUCTION

Your HEATHKIT Model HO-10 Monitor Scope was designed as a small, compact instrument to be used with an amateur station for "on-the-air" signal monitoring. The Scope can be used on ham bands, 160 through 6 meters, without additional tuning or modification.

The Monitor Scope will present envelope, AF trapezoid, and RF trapezoid patterns by connecting it to the transmitter and/or power amplifier. It is also possible to monitor other amateur radio signals by using the Monitor Scope in con-

junction with your receiver.

A two-tone (1000 and 1700 cps) sine wave audio oscillator for single sideband adjustment and other test work is built into the Scope. The Scope also features a special CRT shield to minimize stray field effects on the trace.

Its small physical size and built-in, transformer-operated power supply permit the Scope to be placed most anywhere in the ham shack for convenience in operation.

CIRCUIT DESCRIPTION

Refer to the Schematic Diagram to follow the circuit and to identify circuit components while reading this description.

The RF signal from a transmitter is monitored on the Scope by sampling a portion of the RF voltage from the coaxial antenna feed line. This signal is coupled through the XMTR ATTEN switch to the vertical deflection plates of CR tube V5. The XMTR ATTEN switch provides a capacitive divider network with attenuation of approximately 6 db per step. When it is connected into a properly terminated 50 or 75 Ω transmission line, transmitters as low as five watts and as high as several kilowatts can be used. Since the Scope input is untuned it is essentially independent of frequency from several kilocycles to more than 100 megacycles, although some distortion of pattern may exist when used on 2 meters.

A receiver signal display is accomplished by sampling a portion of the signal voltage in the IF circuit of the receiver. This signal is applied to the VERT input jack on the rear of the Scope. The proper amount of receiver IF signal is coupled from the VERT input jack through VERT GAIN control R3 to the grid of vertical amplifier tube V2A. The signal is amplified and coupled through capacitor C3 to the grid of deflection amplifier tube, V2B. Again, the signal is amplified and then coupled through capacitor C5 to the vertical deflection plates of CR tube, V5.

HORIZONTAL AMPLIFIER

The horizontal amplifier uses the third section of a type 6C10 triple triode compactron tube, V3C. The signal voltage applied to this stage is adjusted by HOR GAIN control R20. The choice of horizontal input signals is determined by the position of the FUNCTION switch. In the SINE position, the horizontal signal is obtained from the variable frequency sweep generator; in the AF TRAP position, the horizontal signal is obtained externally from the transmitter or

other source through the HOR input jack. When the FUNCTION switch is in the RF TRAP position, rectified RF voltage, obtained from the EXCIT input jack, is applied to horizontal deflection amplifier tube, V3C. The amplified horizontal signal is coupled through capacitor C15 to the horizontal deflection plates of the CR tube.

SWEEP GENERATOR

The sweep generator circuit is made up of the first two sections of the 6C10 triple triode compactron tube, V3A and V3B. These two tube sections are connected in such a manner that they operate as a free-running multivibrator sawtooth generator. The sweep frequency can be varied over a range of approximately 15 to 200 cps by adjusting SWEEP FREQ control R21.

TWO-TONE OSCILLATOR

The two-tone oscillator circuit uses a twin pentode compactron tube, V4, as two nearly identical phase shift oscillators. Each section uses a P.E.C. (packaged electronic circuit) phase shift network containing five 500 $\mu\mu\text{f}$ capacitors and four 470 K Ω resistors. (See insert on Schematic.) This circuit is a 3-terminal network designed to produce 180 degrees phase shift from terminal 1 to terminal 3 at approximately 1000 cps.

In either tube section the circuit will oscillate at the frequency where the total phase shift around the loop (grid to plate and back to grid again by way of the P.E.C.) is zero degrees (or 360 degrees). In the case of the 1000 cps section, the large electrolytic capacitor in the cathode circuit is adequate to provide complete bypassing with the result that the tube exhibits the 180 degrees phase inversion of a normal RC coupled amplifier at mid-frequencies. This section will therefore oscillate at the frequency where the P.E.C. can give an added 180 degrees shift or approximately 1000 cps.

In the 1700 cps section, the cathode is not completely bypassed; that is, the reactance of the .05 μ fd capacitor is appreciable in comparison to the resistance it bypasses. This results in some added phase shift within the tube which requires that the shift of the P.E.C. be somewhat less than 180 degrees. The nature of the phase shift network is such that as the frequency is increased, the phase shift through the unit decreases. At a higher frequency (approximately 1700 cps), the phase shifts contributed by the P.E.C., the effect of incomplete cathode bypassing, plus the tube inversion add up to the required zero or 360 degrees which determines the frequency of oscillation of this section.

Although the potentiometers in the cathode circuits will change frequency slightly, they are primarily provided to adjust gain of these stages for good class A operation and allow balancing of the two oscillator outputs. Under these conditions, the output will be a relatively harmonic-free waveform.

CLAMPER CIRCUIT

During a setup for a trapezoid display of a transmitted signal, the trace will reduce to a spot when no signal is present. This spot can burn the phosphor on the face of the CR tube if it is left at a high brightness for a prolonged length of time. A clamper circuit made up of triode V1B and diode V1C causes the spot to be deflected off the screen during no-signal conditions. This circuit is activated when the FUNCTION switch is in either of the TRAP positions and the pull switch on the SWEEP FREQ control is pulled out.

POWER SUPPLY

The transformer operated power supply uses a 1V2 tube, V6, in a half-wave rectifier circuit to provide -1600 volts for the CR tube. Also, a full-wave voltage doubler circuit provides +270 and +580 volts. This circuit uses four silicon diode rectifiers. Resistors R40, R41, R42, and R43, and capacitors C23, C24, C25, C26, C28, and C29 make up the B+ filtering network; resistor R44 and capacitors C30 and C31 make up the high voltage filtering circuit.

CONSTRUCTION NOTES

This manual is supplied to assist you in every way to complete your kit with the least possible chance for error. The arrangement shown is the result of extensive experimentation and trial. If followed carefully, the result will be highly stable and dependable performance. We suggest that you retain the manual in your files for future reference, both in the use of the equipment and for its maintenance.

UNPACK THE KIT CAREFULLY AND CHECK EACH PART AGAINST THE PARTS LIST. In so doing, you will become acquainted with the

parts. Refer to the information on the inside covers of the manual to help you identify the components. If some shortage or parts damage is found in checking the Parts List, please read the Replacements section and supply the information called for therein.

Resistors generally have a tolerance rating of 10% unless otherwise stated in the Parts List. Tolerances on capacitors are generally even greater. Limits of +100% and -20% are common for electrolytic capacitors.

We suggest that you do the following before work is started:

1. Lay out all parts so that they are readily available.
2. Provide yourself with good quality tools. Basic tool requirements consist of a screwdriver with a 1/4" blade; a small screwdriver with a 1/8" blade; long-nose pliers; wire cutters, preferably separate diagonal cutters; a penknife or a tool for stripping insulation from wires; a soldering iron (or gun) and rosin core solder. A set of nut drivers and a nut starter, while not necessary, will aid extensively in construction of the kit.

Most kit builders find it helpful to separate the various parts into convenient categories. Muffin tins or molded egg cartons make convenient

trays for small parts. Resistors and capacitors may be placed with their lead ends inserted in the edge of a piece of corrugated cardboard until they are needed. Values can be written on the cardboard next to each component. The illustration shows one method that may be used.

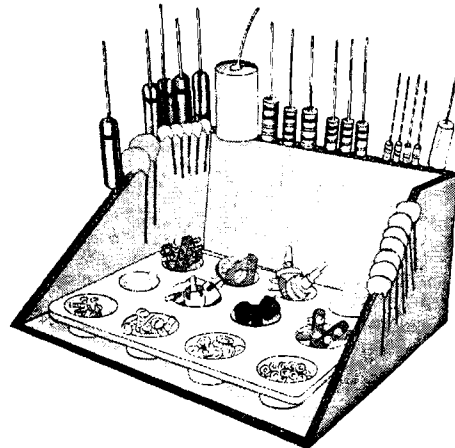

PARTS LIST

The numbers in parentheses in the Parts List are keyed to the numbers in the Parts drawings to aid in parts identification.

PART No.	PARTS Per Kit	DESCRIPTION
<u>Resistors</u>		
(1) 1-4	1	330 Ω 1/2 watt (orange-orange-brown)
1-10	3	1200 Ω 1/2 watt (brown-red-red)
1-13	3	2700 Ω 1/2 watt (red-violet-red)
1-19	6	6800 Ω 1/2 watt (blue-gray-red)
1-25	4	47 KΩ 1/2 watt (yellow-violet-orange)
1-26	2	100 KΩ 1/2 watt (brown-black-yellow)

PART No.	PARTS Per Kit	DESCRIPTION
<u>Resistors (cont'd.)</u>		
1-29	4	220 KΩ 1/2 watt (red-red-yellow)
1-31	5	330 KΩ 1/2 watt (orange-orange-yellow)
1-35	5	1 megohm 1/2 watt (brown-black-green)
1-38	3	3.3 megohm 1/2 watt (orange-orange-green)
(2) 1A-2	2	1000 Ω 1 watt (brown-black-red)
1A-26	1	15 KΩ 1 watt (brown-green-orange)

(1)



(2)



PART No.	PARTS Per Kit	DESCRIPTION
----------	---------------	-------------

PART No.	PARTS Per Kit	DESCRIPTION
----------	---------------	-------------

Resistors (cont'd.)

Capacitors (cont'd.)

- 1A-27 3 33 K Ω 1 watt (orange-orange-orange)
- (3) 1B-24 2 100 K Ω 2 watt (brown-black-yellow) (3)

- (8) 25-63 1 30-20-20-20 μ fd at 450-400-350-300 V twist-prong electrolytic
- (9) 25-41 2 40 μ fd 350 V electrolytic tubular

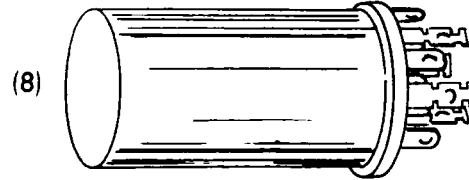

Capacitors

- (4) 20-52 1 7.5 μ fd resin dipped mica
- 20-99 2 22 μ fd resin dipped mica
- 20-102 1 100 μ fd resin dipped mica
- (5) 21-14 7 .001 μ fd disc ceramic
- 21-72 2 .005 μ fd 1.4 KV disc ceramic
- 21-31 5 .02 μ fd 500 V disc ceramic
- 21-38 1 .02 μ fd 1.6 KV disc ceramic
- 21-94 3 .05 μ fd 10 V disc ceramic
- 23-94 2 .15 μ fd 1.6 KV tubular
- (6) 23-49 3 .22 μ fd 400 V tubular
- 27-21 1 2 μ fd 200 V mylar tubular
- 28-1 1 2.2 μ fd tubular (red-red-white)
- (7) 25-54 1 10 μ fd 10 or 15 V electrolytic

Controls-Switches

- (10) 10-52 2 2 K Ω linear control (tab mount)
- (11) 10-26 2 500 K Ω linear control
- 10-32 3 1 megohm linear control
- (12) 19-78 1 500 K Ω linear control with SPST switch
- (13) 19-76 1 7.5 megohm linear control with SPST push-pull switch
- (14) 63-40 1 2-pole 3-position rotary switch

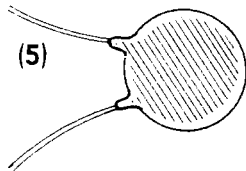
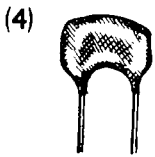
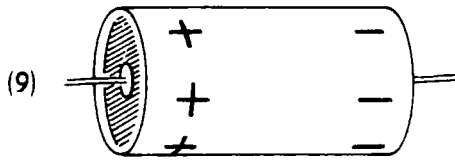

(10)

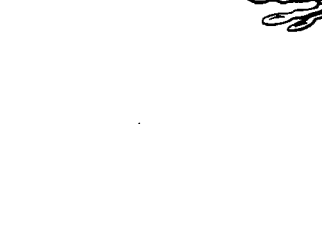
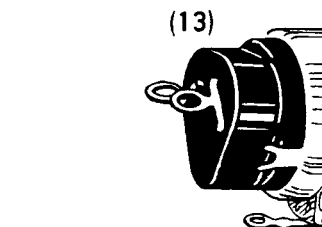
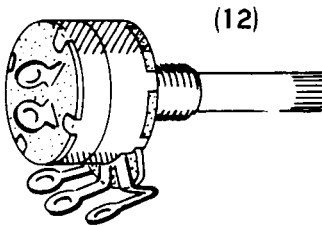
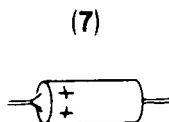
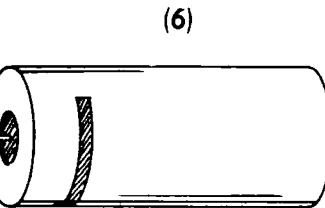
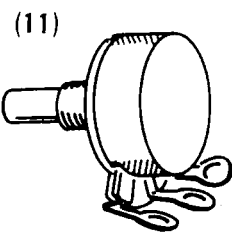

(11)

(12)

(14)

(13)

(7)

(4)

(5)

(6)

PART No.	PARTS Per Kit	DESCRIPTION
<u>Controls-Switches (cont'd.)</u>		
(15) 63-77	1	1-pole 3-position progressive-ly-shorting rotary switch
(16) 63-138	1	1-pole 4-position rotary switch

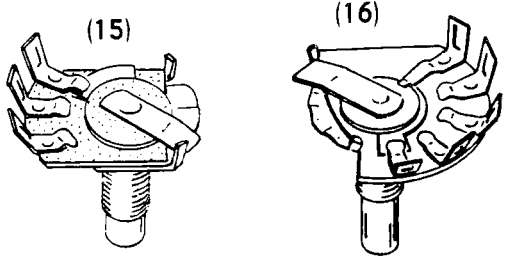

PART No.	PARTS Per Kit	DESCRIPTION
<u>Plugs</u>		
(24) 438-4	5	Phono plug
(25) 438-11	1	Fused AC plug

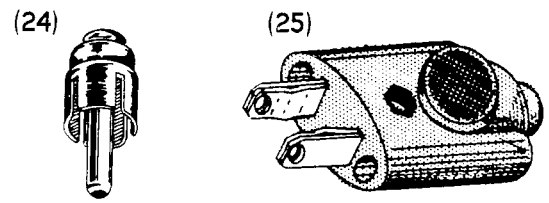

PART No.	PARTS Per Kit	DESCRIPTION
<u>Terminal Strips-Sockets</u>		
(17) 431-10	6	3-lug terminal strip
(18) 431-11	1	5-lug terminal strip
(19) 431-14	2	2-lug terminal strip

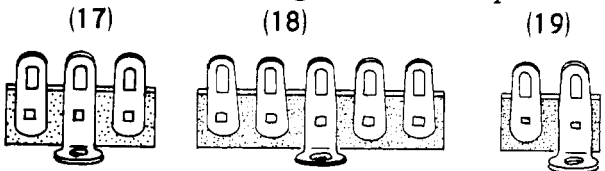

PART No.	PARTS Per Kit	DESCRIPTION
<u>Tubes-Lamp</u>		
411-25	1	12AU7 tube
411-65	1	1V2 tube
411-128	1	6BN8 tube
411-142	1	3RP1 CR tube
411-167	1	6C10 tube
411-168	1	6J11 tube
(26) 412-13	1	Pilot lamp (red neon)

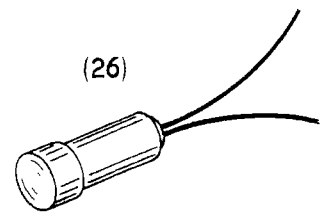

(20) 434-41	1	12-pin CRT socket
(21) 434-56	3	9-pin miniature socket
(22) 434-76	1	Triple phono socket
434-82	1	Double phono socket
(23) 434-121	2	12-pin compactron socket

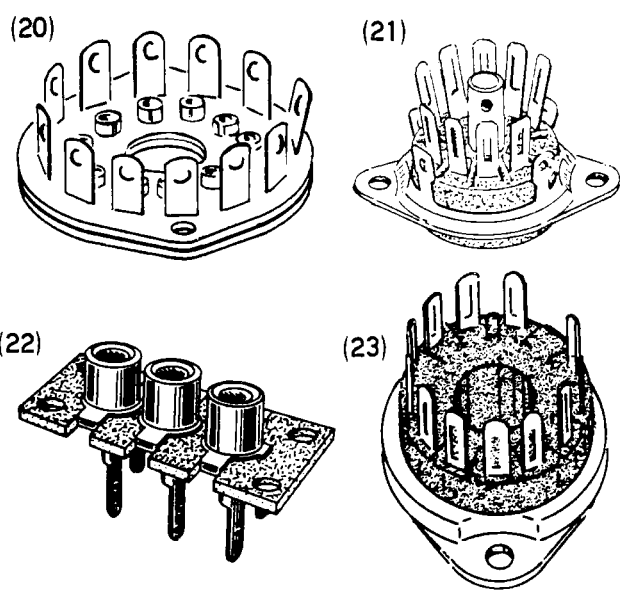

PART No.	PARTS Per Kit	DESCRIPTION
<u>Hardware</u>		
(27) 250-174	4	8-32 x 1/4" screw
(28) 250-56	14	6-32 x 1/4" screw
(29) 250-89	15	6-32 x 3/8" screw
(30) 250-48	2	6-32 x 1/2" screw (round head)
(31) 250-49	23	3-48 x 1/4" screw
(32) 250-172	1	3-48 x 3/8" screw
(33) 250-51	2	#10 x 3/8" sheet metal screw

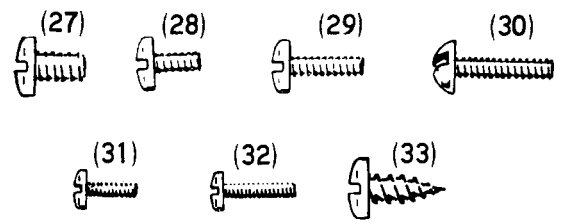

PART No.	PARTS Per Kit	DESCRIPTION
----------	---------------	-------------

PART No.	PARTS Per Kit	DESCRIPTION
----------	---------------	-------------

Hardware (cont'd.)

Wire-Sleeving

- (34) 252-7 16 Control nut
- (35) 252-4 4 8-32 nut
- (36) 252-3 25 6-32 nut
- (37) 252-1 24 3-48 nut

- 89-4 1 Line cord
- 340-9 1 Length bare wire
- 343-5 1 Length RG-62U cable
- 343-6 1 Length audio cable
- 344-58 1 Length hookup wire
- 344-13 1 Length #22 HV hookup wire
- 346-1 1 Length sleeving

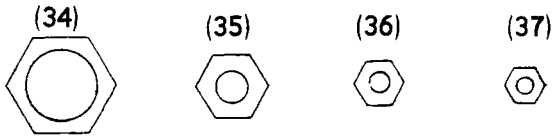

Sheet Metal Parts

- (38) 252-32 1 Large push-on speednut
- (39) 253-10 10 Control flat washer
- (40) 253-40 1 Spring steel washer
- (41) 254-4 5 Control lockwasher
- (42) 254-2 3 #8 lockwasher
- (43) 254-1 48 #6 lockwasher
- (44) 254-7 25 #3 lockwasher

- 90-230 1 Cabinet
- (52) 100-M329 1 CRT front mounting ring
- 200-M357F823 1 Chassis
- 200-M358F739 1 Chassis enclosure
- 203-319F738 1 Front panel
- (53) 207-M1 2 CRT rear mounting clamp
- (54) 210-20F 1 Front bezel

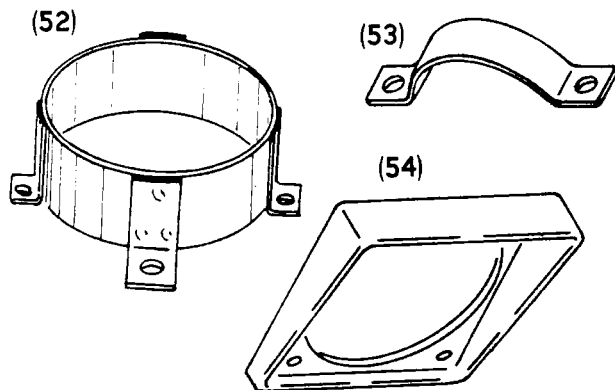
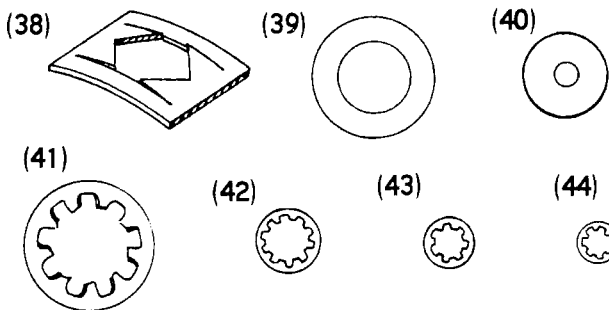

- (45) 259-10 1 Control solder lug
- (46) 259-2 1 #8 solder lug
- (47) 259-1 3 #6 solder lug (large)
- (48) 259-6 1 #6 solder lug (small)
- (49) 255-11 2 5/16" x 1" 6-32 spacer
- (50) 255-55 1 5/8" x 3/4" phenolic spacer
- (51) 455-9 1 3/8" x 3/8" brass bushing

Miscellaneous

- (55) 45-4 1 RF choke
- 54-130 1 Power transformer
- (56) 57-27 4 Silicon rectifier

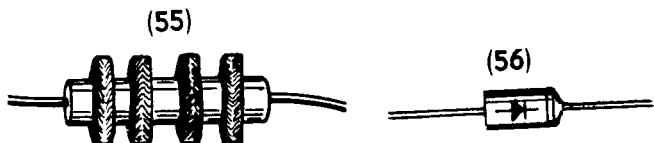
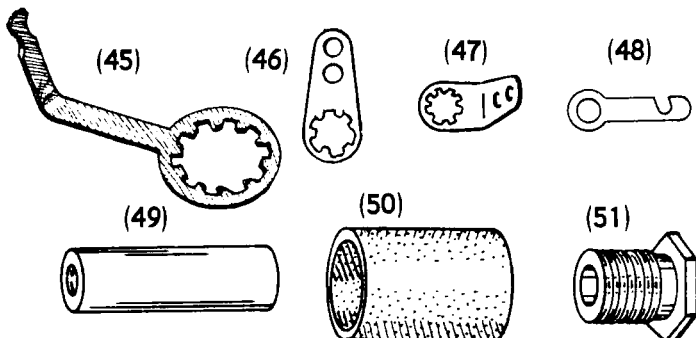

PART No.	PARTS Per Kit	DESCRIPTION	PART No.	PARTS Per Kit	DESCRIPTION
<u>Miscellaneous (cont'd.)</u>			<u>Miscellaneous (cont'd.)</u>		
(57) 73-4	2	Grommet	414-9	1	Grid screen
(58) 73-5	1	Rubber cushion strip	421-20	2	1/2 ampere slow-blow fuse
(59) 75-30	1	Line cord strain relief	(66) 436-5	2	Coaxial jack
(60) 84-22	2	Phase shift network (P.E.C.)	462-168	10	Knob
(61) 206-180	1	CRT neck shield	(67) 481-1	1	Electrolytic capacitor mounting wafer (metal)
(62) 206-58	1	CRT mu-metal shield	331-6		Solder
(63) 207-22	1	Plastic clamp	595-578	1	Manual
(64) 261-9	4	Feet (short)			
(65) 261-20	2	Feet (long)			

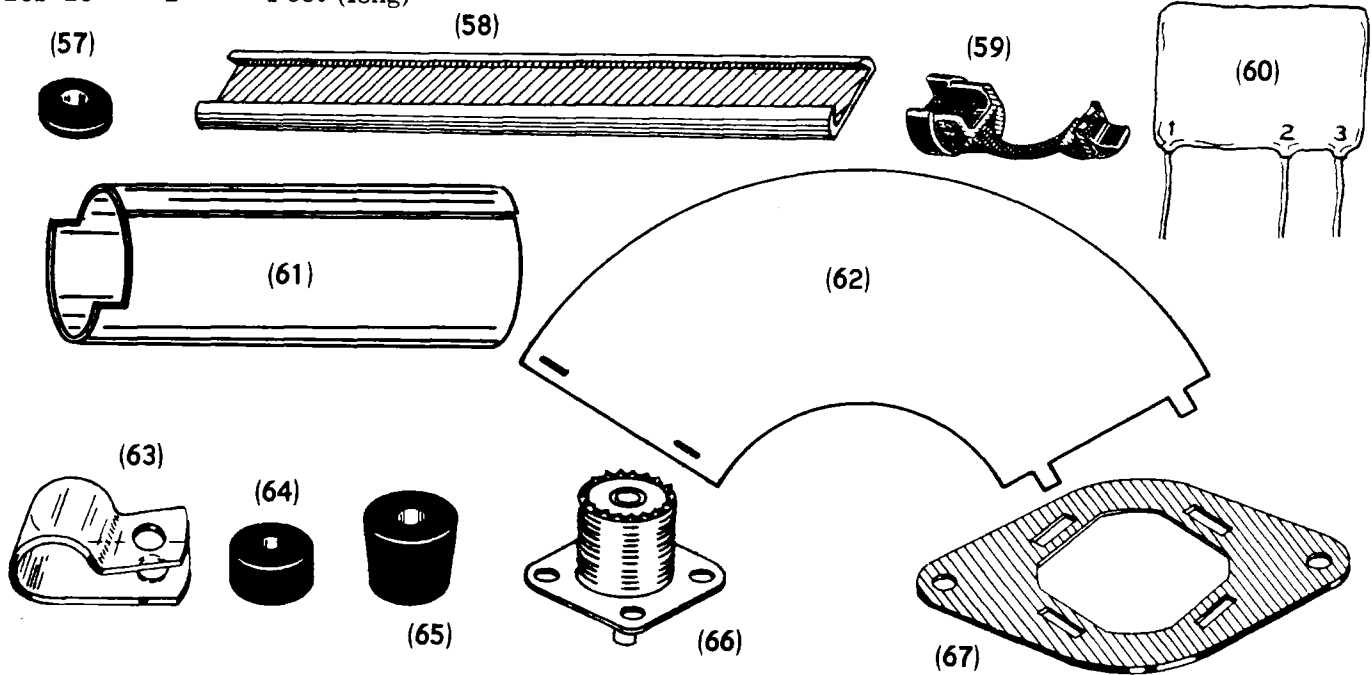

PROPER SOLDERING TECHNIQUES

Only a small percentage of customers find it necessary to return equipment for factory service. By far the largest portion of malfunctions in this equipment are due to poor or improper soldering.

If terminals are bright and clean and free of wax, frayed insulation and other foreign substances, no difficulty will be experienced in soldering. Correctly soldered connections are essential if the performance engineered into a kit is to be fully realized. If you are a beginner with no experience in soldering, a half hour's practice with some odd lengths of wire may be a worthwhile investment.

For most wiring, a 25 to 100 watt iron or its equivalent in a soldering gun is very satisfactory. A lower wattage iron than this may not heat the connection enough to flow the solder smoothly. Keep the iron tip clean by wiping it from time to time with a cloth.

CHASSIS WIRING AND SOLDERING

1. Unless otherwise indicated, all wire used is the type with colored insulation (hookup wire). In preparing a length of hookup wire, 1/4" of insulation should be removed from each end unless directed otherwise in the assembly step.

TEST AND ADJUSTMENT

INITIAL CHECK

If an ohmmeter is available, the following checks should be made **PRIOR TO APPLYING POWER** to the unit. Refer to Pictorial 12 (fold-out from Page 6) for the test points indicated.

- () With the negative meter lead to ground lug G and the positive lead to lug 1 of V6, the resistance reading after a brief capacitor charging period should be approximately 5 megohms.
- () With the negative meter lead to ground lug G and the positive lead to lug 4 of terminal strip C, the resistance reading should be greater than 100 K Ω after a sufficient capacitor charging period.
- () With the negative meter lead to lug 4 of terminal strip C, and the positive lead to lug 1 of terminal strip C, the resistance reading should be greater than 100 K Ω after a sufficient capacitor charging period.

Refer to Pictorial 18 for the following steps.

CAUTION: VOLTAGES IN THIS INSTRUMENT ARE DANGEROUS. Extreme care should be exercised whenever the instrument is operated or handled without being installed in the cabinet. Some of the highest voltages in the circuit appear on the CR tube socket and INTENSITY control terminals, just below the CR tube socket. These voltages could be fatal.

We suggest that you pre-read this section of the manual before performing the following steps.

- () Referring to Detail 18A, temporarily connect a jumper wire from lug 2 to lug 3 (VERT to TONE) of phono socket BB.

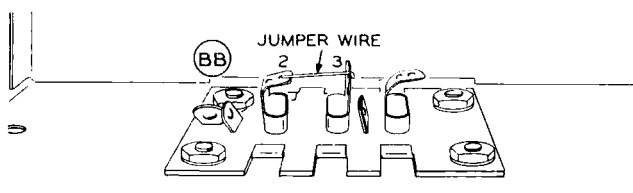

Detail 18A

- () Set the controls as follows before connecting the line cord to an AC outlet.

FUNCTION-SINE

SWEEP FREQUENCY-Pushed in and full counterclockwise.

TONE GEN - OFF.

HOR GAIN - Full counterclockwise.

HOR POS - Center of rotation.

VERT POS - Center of rotation.

VERT GAIN - Full counterclockwise.

FOCUS - Center of rotation.

INTENSITY - OFF.

1000 ~ TONE ADJUSTMENT - Full clockwise.

1700 ~ TONE ADJUSTMENT - Full clockwise.

- () Plug the line cord into a 105-125 volt 50/60 cps AC outlet. **CAUTION:** This instrument may be seriously damaged if connected to a DC power source or more than 125 volts AC.
- () Turn the INTENSITY control approximately 3/4 of its rotation. This will apply power to the Scope. The red neon pilot lamp and all tube filaments should glow, except in the 1V2 tube. This tube uses a filament voltage of less than 1 volt and, for all practical purposes, there will be no glow. Allow one minute for the tubes to warm up.
- () Watch the center of the screen until a spot appears. If no spot appears, rotate both the HOR POS and the VERT POS knobs simultaneously until a spot is located. If the spot can not be located, turn the unit off and refer to the In Case Of Difficulty section on Page 56.
- () Adjust the INTENSITY control until the spot is clearly visible, but not overly bright.
- () Adjust the FOCUS control for the smallest, sharpest dot.
- () Rotate the HOR POS control and notice that the spot moves horizontally across the screen. Now turn the VERT POS control and the spot will move up and down. Adjust these two controls so that the spot is centered on the screen.

- () With the spot centered, slowly turn the HOR GAIN control clockwise. The spot should now become a horizontal line.

NOTE: A small amount of ripple (hum) may be present on the trace. This is normal and will not interfere with the monitoring functions for which this Scope is intended.

If the angle of the trace is not perfectly horizontal, correct this condition as follows:

- () Observe the position of the trace on the CR tube and estimate how far the CRT should be turned. Turn off the power, pull the line cord plug. Allow approximately 30 seconds for the filter capacitors to discharge. As an added safety precaution, pin 1 of the 1V2 high voltage rectifier and the (+) leads of the large electrolytic capacitors should be momentarily shorted to the chassis with an insulated screwdriver to provide complete discharge. Loosen the clamp at the neck of the CRT and rotate the tube the proper amount by turning its socket. Do not allow the tube to slide forward and come into contact with the grid screen.

This process may be repeated if the trace is still slightly tilted. When finished, carefully tighten the CR tube neck clamp to hold the tube in place.

- () Turn the VERT GAIN control fully clockwise.
- () Turn the SWEEP FREQ control to the 1 o'clock position.
- () Turn the TONE GEN switch to the 1 KC position.
- () Watch the line on the screen and very slowly turn the 1000~ TONE ADJUSTMENT control counterclockwise until a very small signal can be seen on the horizontal line. This indicates that the 1 kc oscillator is operating and the signal indication will be approximately 1/32". After obtaining the signal, turn this control 1/16 turn farther.
- () Turn the TONE GEN switch to the 2-TONE position and repeat the above step turning the 1700 ~ TONE ADJUSTMENT control

until a second signal can be seen superimposed on the 1 kc signal. Then turn this control 1/16 turn farther.

If the Scope is to be used with a SSB transmitter, the above two controls should be adjusted later to provide equal output from each tone. This requires connecting the transmitter and Scope as outlined under Transmit Envelope Patterns and adjusting the 1000 ~ and 1700 ~ controls to provide a clean "Trough" crossover as illustrated in Envelope pattern #10.

- () Turn the tone generator switch OFF, the FUNCTION switch to AF TRAP, and rotate the HOR GAIN control fully clockwise. There should now be a spot. Pulling the Clamp switch on the sweep frequency control should cause the spot to move off the screen to the right.
- () Return the Clamp switch to its off position and turn the Function switch to RF TRAP. There should again be a spot which can be clamped off the screen face by pulling the Clamp switch. Leave the Clamp switch in the off position and return the FUNCTION switch to AF TRAP.
- () Turn the Scope off and remove the jumper wire previously connected between lugs 2 and 3 of phono socket BB. (See Detail 18A and Pictorial 13.)
- () Temporarily connect a jumper wire from lug 5 of phono socket BB (HOR input) to lug 5 of the 6BN8 socket, V1.
- () Turn the unit on and note that there should now be a horizontal line whose width can be adjusted by the HOR GAIN control. Rotating the SWEEP FREQ control should have no effect and placing the FUNCTION switch in the RF TRAP position should reduce the line to a spot.
- () Turn the Scope off and remove the temporarily installed jumper wire from lug 5 of phono socket BB to tube socket V1.

This completes the Test and Adjustment section. Proceed to Final Assembly.

OPERATION

GENERAL INSTRUCTIONS

The Monitor Scope is now assembled and checked out. Before attempting to use the Scope, we suggest that you familiarize yourself with the operation of its various controls. They are listed below in the usual sequence of operation.

INTENSITY - The INTENSITY control incorporates the AC Power switch and also varies the brightness of the pattern on the screen. It should be adjusted for a clear trace. CAUTION: Excessive brightness for prolonged periods of time could burn the phosphor on the face of the CR tube.

FOCUS - There may be some interaction between the FOCUS and INTENSITY controls. Adjust each for the best focus at the desired intensity level.

HOR POS, VERT POS - These controls determine the position of the trace on the CR tube screen. During initial set up, these controls should be set to the center of their rotation.

HOR GAIN - The HOR GAIN control varies the input to the horizontal amplifier. Adjust the control until the display is approximately the width of the square grid screen printing.

VERT GAIN - The VERT GAIN control varies the input to the vertical amplifier during receiver monitoring conditions. Under transmit conditions, the vertical height can be varied with the XMTR ATTEN switch, located on the rear panel of the Scope.

FUNCTION - The FUNCTION switch selects the type of pattern displayed on the screen; SINE, AF TRAPezoid, or RF TRAPezoid.

TONE GEN - The TONE GEN switch controls operation of the built-in sine wave oscillators. By turning it to the desired position, either a single 1000 cps tone or the two-tones, 1000 and 1700 cps superimposed, may be obtained.

SWEEP FREQ - This control adjusts the sweep generator frequency. It should be adjusted to obtain the proper sweep rate for the desired display pattern.

CLAMP SWITCH - When the FUNCTION switch is in one of the TRAPezoid positions, the Clamp switch located on the SWEEP FREQ control may be pulled out to deflect the spot off the side of the screen when there is no output from the transmitter. Otherwise, if a focused spot is left stationary for a long period of time, it may result in a phosphor burn on the CR tube face.

When used with transmitters or sufficient power input (generally in excess of 100 watts), the clamp will automatically "release" and revert to a normal trapezoid pattern with the application of RF through the ANT terminals. When used with lower powered transmitters, the clamp feature is best left off, otherwise the clamp will not release completely or allow a stationary pattern.

INITIAL CONTROL SETTINGS

Each time a different setup is used for monitoring, set the front panel controls as follows: After a display is present on the screen of the Scope, adjust the controls for the desired display.

FUNCTION Switch	-	Desired function.
SWEEP FREQ	-	Pushed in and at the 12 o'clock position.
TONE GEN	-	As required.
HOR GAIN	-	12 o'clock.
HOR POS	-	12 o'clock.
VERT POS	-	12 o'clock.
VERT GAIN	-	12 o'clock.
FOCUS	-	12 o'clock.
INTENSITY	-	3 o'clock.

SCOPE CONNECTIONS

In addition to the following, much information on the use of oscilloscopes for amateur test purposes may be found in any recent edition of the ARRL, "The Radio Amateur's Handbook."

RECEIVER MONITORING (FIGURE 1)

The receiver monitoring feature of this Scope is designed to operate with tube type receivers having an IF frequency of 500 kc or below. As the Scope incorporates a broadband amplifier, no tuning is required.

In order to monitor received signals it is necessary to connect into the last IF stage of the receiver. A typical circuit is shown in Figure 1A. It is necessary to loosely couple the Scope to prevent excessive loading and detuning effects of the IF amplifier stage. This coupling capacitor will typically be between 5 and 30 $\mu\mu\text{f}$. The addition of this capacitor may slightly detune the preceding IF transformer, therefore, it should be retuned after all connections have been made. NOTE: If you do not have enough gain to view the signal, increase the size of the coupling capacitor up to 75 $\mu\mu\text{f}$.

1. Connect the RG-62 coaxial cable supplied from the grid (preferably) or plate of the last IF stage through a small value capacitor (5-30 $\mu\mu\text{f}$) to the VERT jack on the rear of the Scope.

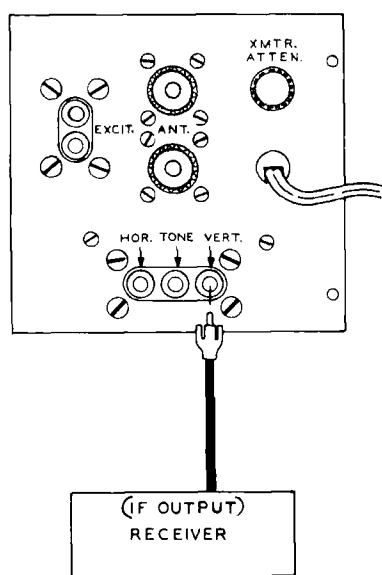

Figure 1

2. Place the front panel controls as directed in the Initial Control Settings section.
3. Adjust the VERT GAIN, HOR GAIN, and SWEEP FREQ controls for the desired display.

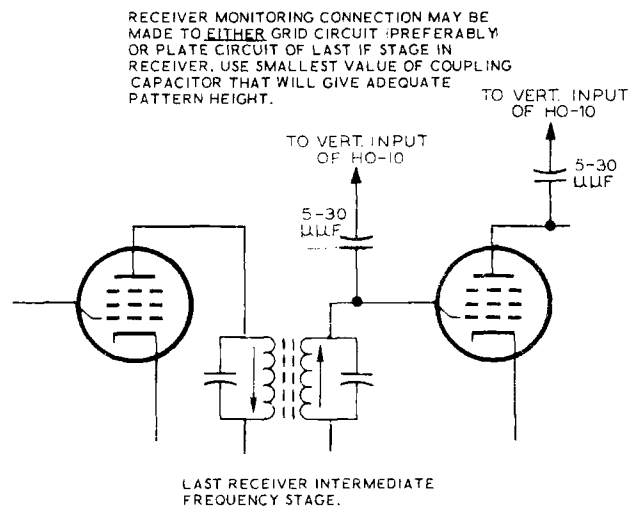

Figure 1A

RECEIVER ENVELOPE PATTERNS

With the receiver adjusted for normal operation on an average signal, the VERT GAIN control should be adjusted to produce a pattern approximately 1-1/2" high.

Many of the transmitter patterns described later may also be observed as a received signal. Bearing in mind the limitations described in the following paragraphs, refer to the appropriate sample patterns, depending on the type of signal received.

The receiver can produce several distinct effects which can alter or reshape the incoming signal into a display quite different from that which was transmitted. The two most pronounced effects are produced by the presence of AVC and the narrow bandwidth employed in the newer receivers.

With AVC on during the observance of a pulsing signal such as CW or sideband, the leading portion of the waveform may be displayed with a considerably higher than normal amplitude. It will reduce in height as the AVC takes hold. This effect can most easily be seen by observing the difference between patterns 40 and 41 on Page 54.

The same distortion may be noted when watching voice patterns on sideband, producing momentary apparent flat-topping. This problem can be avoided if the AVC is turned off with the receiver RF gain sufficiently reduced to prevent overload.

RECEIVER PATTERNS

SIGNAL AT XMTR

RECEIVER BANDWIDTH

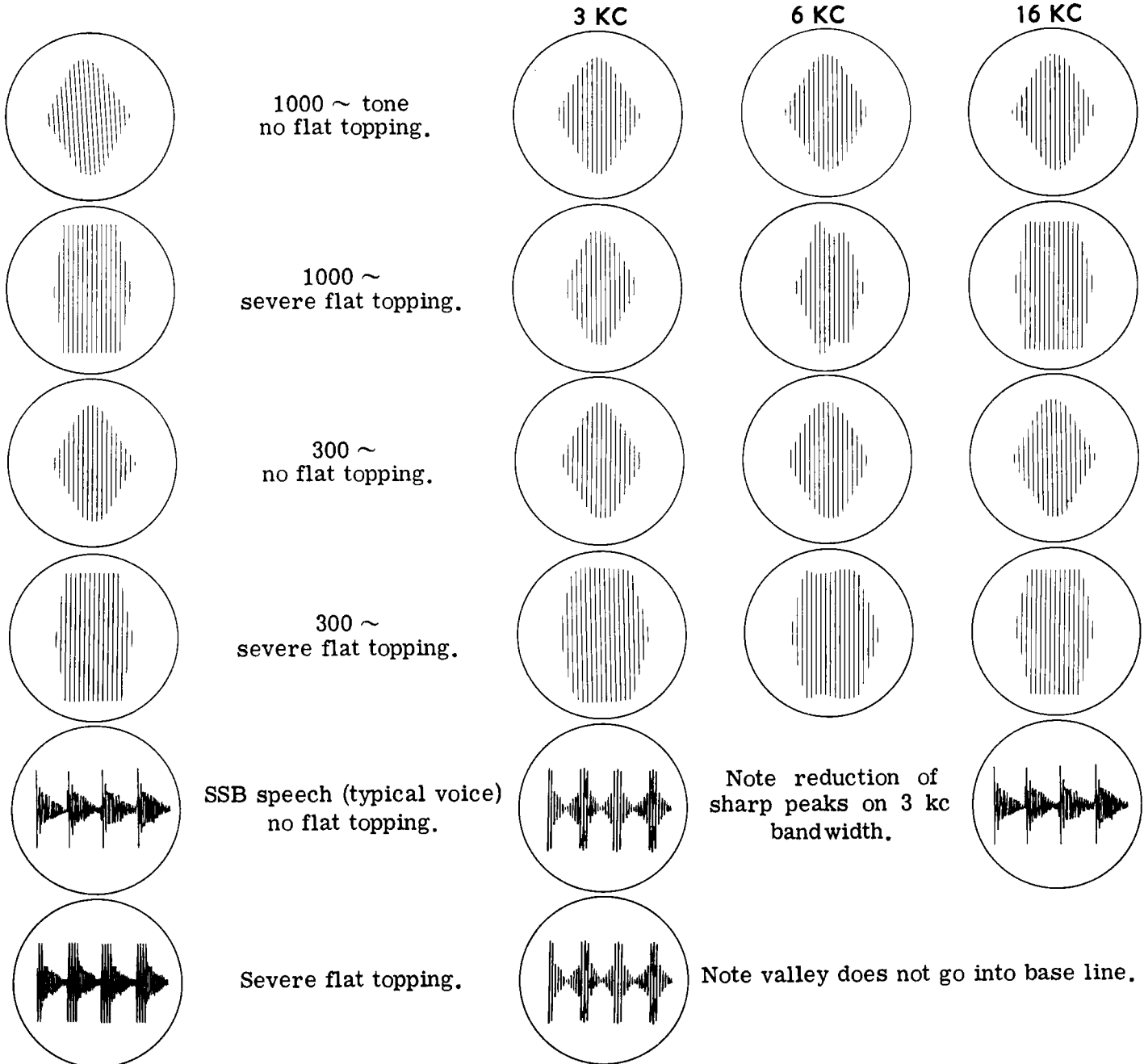

Note reduction of sharp peaks on 3 kc bandwidth.

Note valley does not go into base line.

Figure 1B



The receiver IF bandwidth determines the ability to obtain a true display of an over modulated or square-topped signal. Refer to the pattern sequence shown on Page 42. In order to obtain a true display, the IF bandwidth must be roughly 10 times the modulating frequency. For example, a 3 kc bandwidth will pass a 300 cps square wave but a 1000 cps square wave would be shown as a somewhat distorted sine wave. Therefore, SSB signals that are "flat-topping" may appear acceptable on the RF envelope patterns.

A flat-topped signal can best be determined by observing the lack of peaks and valleys in the IF envelope pattern. See Figure 1B. It is possible that the signal may be deliberately "shaped" by the use of premodulation clipping and filtering in the transmitter, producing a pattern that may appear somewhat flat topped.

TRANSMIT ENVELOPE PATTERNS (FIGURE 2)

Most transmitters have 50-72 Ω coax outputs. The following instructions are written for this type of connection, with either a dummy load or an antenna.

If the feed line to the antenna is other than coaxial cable, it is necessary to use a pickup antenna or a coax-coupled pickup link, placed near the final RF amplifier tank coil, and connected to only one (either) of the rear panel antenna jacks. With open wire or ribbon feed systems, a length of wire placed close to one of the feeders is recommended.

Make sure a dummy load or antenna is connected each time the transmitter is operated, either through the Scope as in the case of coaxial feed, or directly where other antenna transmission line systems are used. When used with the Heath HX-10 or HA-10 equipment, it is recommended that full RF output be connected through the Scope rather than using the special Scope output on these units.

1. Connect the RF output of the transmitter or linear amplifier to either ANT jack of the scope.
2. Connect the dummy load or antenna to the other Scope ANT jack.
3. Set the front panel controls as described on the Initial Control Settings section. Set the XMTR ATTEN switch fully clockwise.

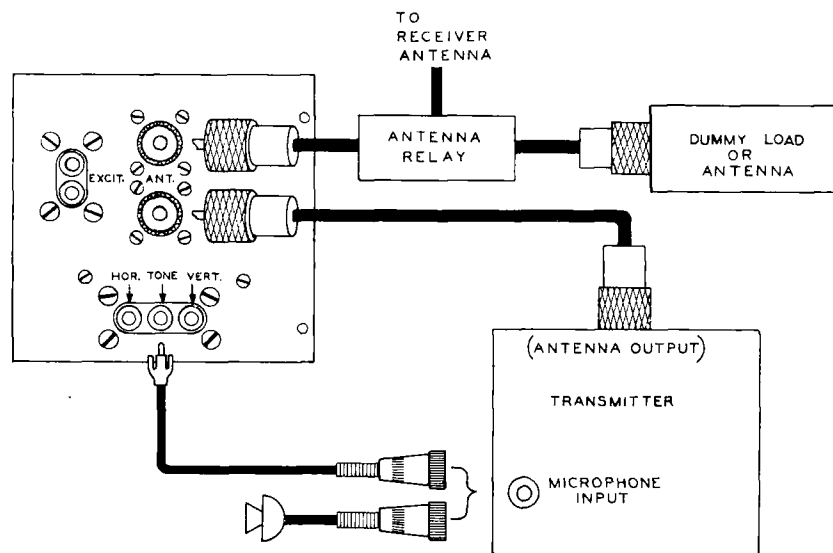

Figure 2

4. Turn on the transmitter and adjust the XMTR ATTN, HOR GAIN, and SWEEP FREQ controls for the desired pattern height and display.
 5. Modulation of an AM or SSB transmitter may be checked by connecting a shielded cable from the TONE output jack of the Scope to the microphone input of the transmitter. If this is done, place the TONE GEN switch to the 1 KC position. A two-tone position is also available for SSB checks and alignment. Voice modulation may be checked by using a microphone to voice modulate the transmitter.
 6. Refer to the Transmit Envelope Patterns on Page 49 to evaluate the transmitter display.
1. Connect a coaxial cable from the RF output of the exciter to either EXCIT input jack of the Scope.
 2. Connect a coaxial cable from the other EXCIT jack on the Scope to the input jack of the linear amplifier.
 3. Connect a coaxial cable from the RF output of the linear amplifier to either ANT jack of the Scope.
 4. Connect the dummy load or antenna to the other ANT jack on the Scope.
 5. Connect the TONE jack to the microphone input of the exciter.

TRANSMIT RF TRAPEZOID PATTERNS (FIGURE 3)

This setup is used to check a linear amplifier for linearity; therefore it is necessary to compare the exciter RF output with the RF output of the linear amplifier.

6. Set all front panel controls on the Scope as directed in the Initial Control Settings section, but with the TONE GEN switch at 2 TONE and the FUNCTION switch in the RF TRAP position.

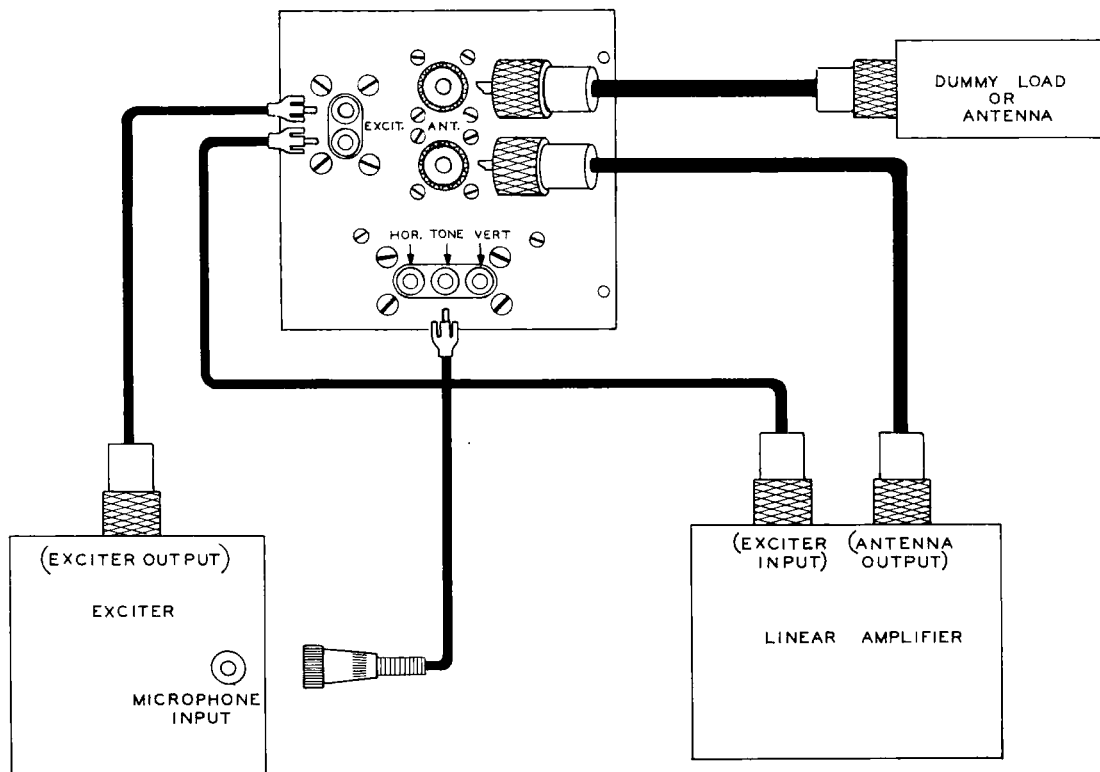

Figure 3

7. Turn on the exciter and linear amplifier and adjust the XMTR ATTEN, HOR-GAIN, and transmitter audio gain controls for the desired display height and pattern.
8. The trapezoid pattern is obtained by comparing the RF output signal of the exciter with the amplified RF output of the linear amplifier. Refer to the Trapezoid Patterns for display analysis.

NOTE: The RF trapezoid pattern only indicates the linearity of the linear amplifier. This set-up should not be used for general monitoring as it does not evaluate the exciter signal.

AF TRAPEZOID PATTERNS (FIGURE 4)

Trapezoid (AM) patterns are obtained by inserting the transmitter RF output to provide vertical deflection (as in the case of envelope display) with the actual modulating signal (audio) providing the horizontal sweep. With no modulation applied, this results in a straight vertical line of carrier amplitude displayed in the center of the screen. When audio is applied, the transmitter output (carrier plus side-bands) increases on the positive half cycle of modulation and decreases on the negative half, producing a trapezoid. In an ideal AM transmitter modulated 100%, the trapezoid extends to a triangle with perfectly straight sides and is essentially independent of the modulating waveform; that is, either voice or tone input to the transmitter may be used.

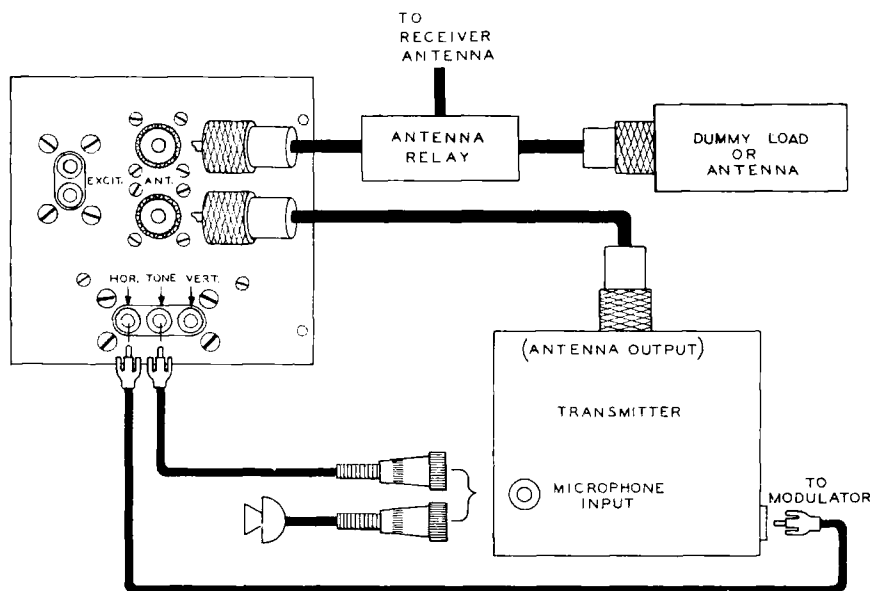

Figure 4

AF TRAPEZOID CONNECTIONS

1. Connect a coaxial cable from the RF output of the transmitter to either ANT jack of the Scope.
2. Connect the antenna or dummy load to the other ANT jack of the Scope.
3. Connect the TONE output jack of the Scope to the microphone jack of the transmitter.
4. It is necessary to obtain a sample of the transmitter audio signal where the audio modulates the RF. This point may be found at the plate or screen grid of the modulated tube. See Figure 4A. Add another 100 K Ω 2 watt resistor in series for each 350 volts over 750 volts. Capacitor CX (100 $\mu\mu\text{f}$ to 200 $\mu\mu\text{f}$) may have to be added to compensate for audio phase shift. It should be a high voltage type, at least 2 KV for Figure 4A.

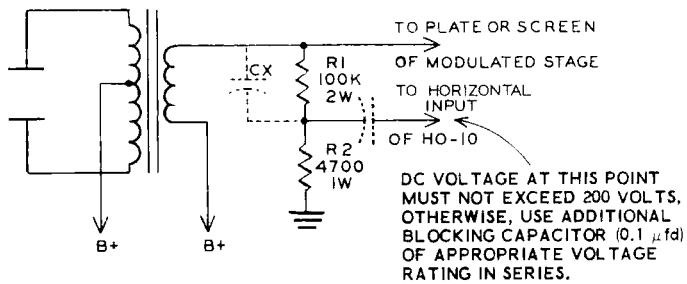

Figure 4A

5. Set the front panel controls as described in the Initial Control Setting section. Set the XMTR ATTEN switch fully clockwise.
6. Turn on the transmitter and adjust the XMTR ATTEN and HOR GAIN controls for the desired pattern height and display.
7. Refer to the AF Trapezoid Patterns for pattern analysis.

RTTY CROSS PATTERNS (FIGURE 5)

This setup enables you to observe the performance and tuning of teletype terminal equipment.

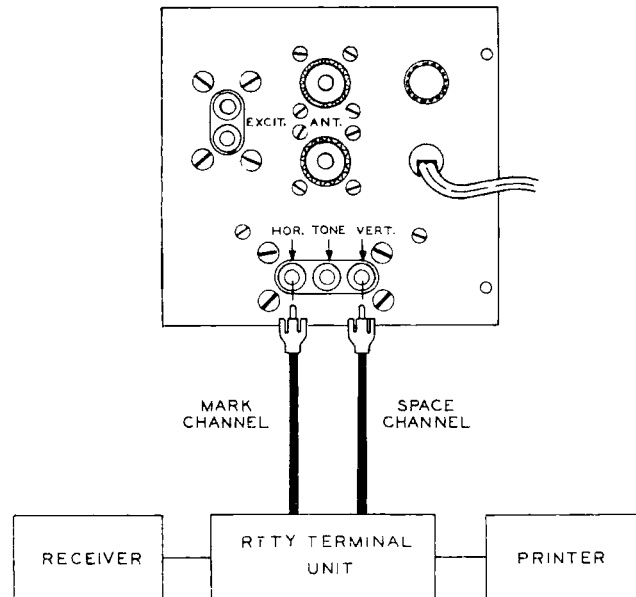

Figure 5

1. Connect a coaxial or shielded cable from the mark channel of the RTTY terminal unit to the HOR input jack of the Scope.
2. Connect a coaxial or shielded cable from the space channel of the RTTY terminal unit to the VERT input jack of the Scope.
3. Set the front panel controls as directed in the Initial Control Settings section.
4. Turn the terminal unit and Scope on, and place the scope FUNCTION switch in the AF TRAP position with the Clamp switch pushed in. The mark and space outputs of the TU should be adjusted to provide equal output voltages from the two channels when properly tuned in. This can be determined by alternately inserting mark and space signals into the Scope VERTICAL input and adjusting the TU balance control for equal height from both channels. Now, with space connected to the VERT input and mark connected to the HOR input, adjust the VERT and HOR GAIN controls on the Scope to produce a cross pattern with equal line (or ellipse) lengths. Once the desired size of the cross pattern has been set, the gain controls on the Scope should not be changed as this will interact with the true setting of the balance control on the terminal unit.
5. Refer to RTTY Cross Patterns on Page 53.

OSCILLOSCOPE USE (FIGURE 6)

The Monitor Scope can be used as a normal oscilloscope for limited test applications where the need for internal sync, high sweep frequency or high vertical amplifier gain is not required. For most applications, the FUNCTION switch will be set in the SINE position where horizontal deflection is obtained from the internal sawtooth sweep generator. Where it is desirable to provide horizontal sweep from an external source, connect the horizontal signal to the HOR input and place the FUNCTION switch in the AF TRAP position (Clamp switch pushed in).

1. Connect a test lead to the VERT input jack, (the normal scope test probe).
2. Connect a test lead to the HOR input jack.
3. Adjust the VERT GAIN, HOR GAIN, and SWEEP FREQ controls for the desired pattern.

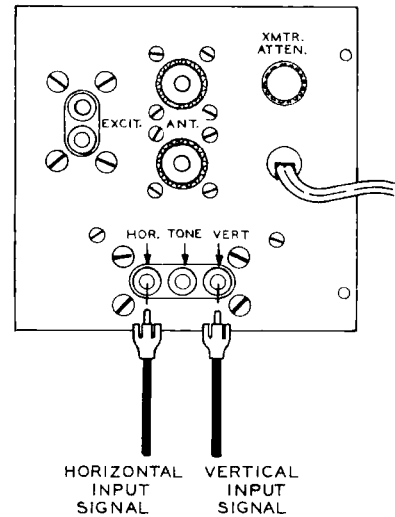

Figure 6

USE WITH CITIZEN'S BAND TRANSCEIVERS (FIGURE 7)

The Monitor Scope can be used with Citizen's Band Transceivers by making the following changes in the scope to increase its vertical sensitivity.

TRANSMIT ENVELOPE PATTERNS

1. Install a coil and capacitor in the Scope vertical input circuit as shown in Figure 7. The coil and capacitor can be obtained from Heath Company. Their part numbers are coil #40-187 and capacitor #20-98.
2. Connect the scope to the transceiver as shown in Figure 2 on Page 43.

AM TRAPEZOID PATTERNS

1. Install a coil and capacitor in the Scope vertical input circuit as shown in Figure 7. The coil and capacitor can be obtained from Heath Company. Their part numbers are coil #40-187 and capacitor #20-98.
2. Connect the Scope to the transceiver as shown in Figure 4 on Page 45. Also see Figure 7A which is a schematic diagram of a typical CB Transceiver output stage.

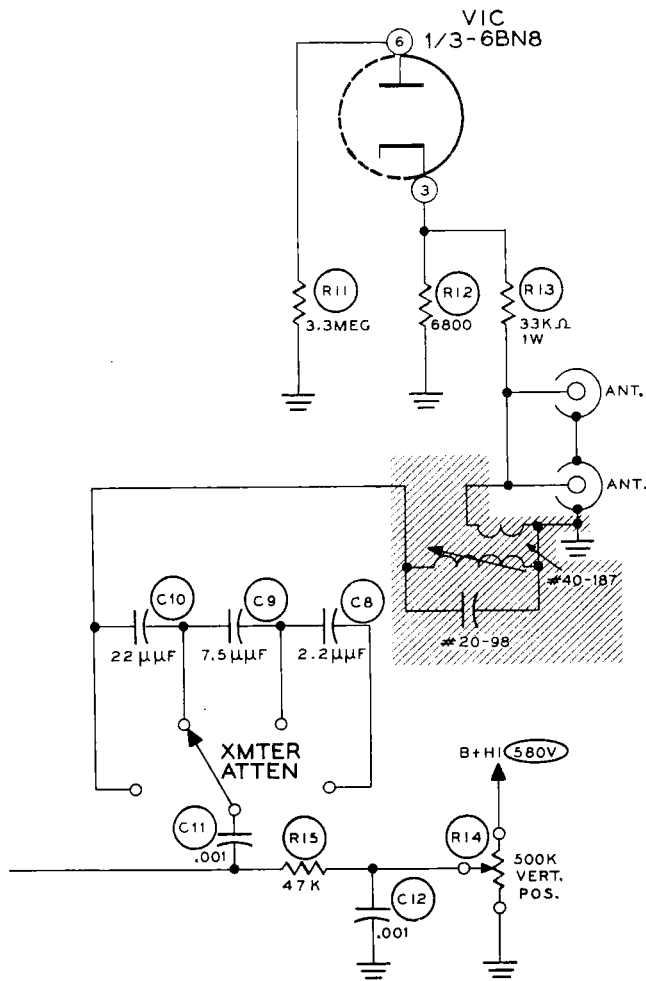

Figure 7

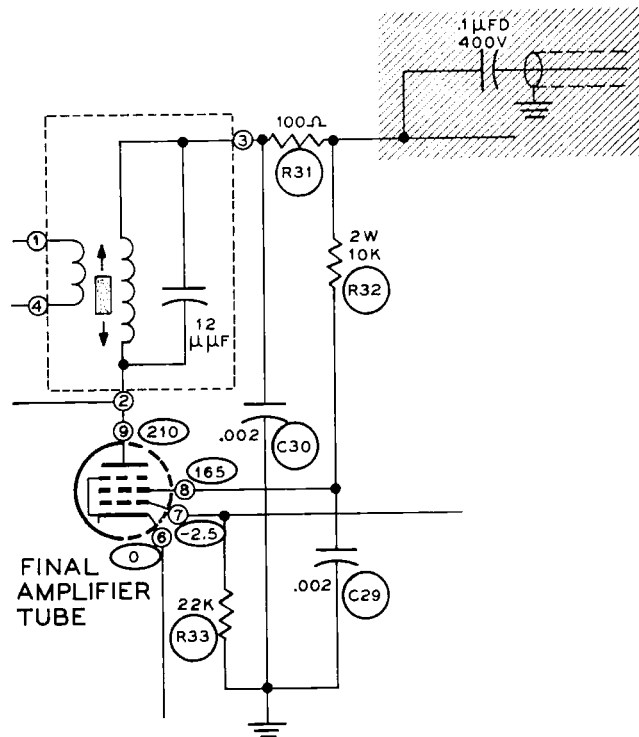
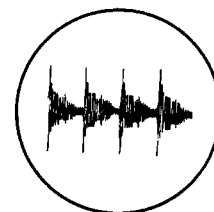

Figure 7A

TRANSMIT ENVELOPE PATTERNS

SSB signal, voice input, correctly adjusted.

1



SSB signal, voice input, slightly excessive speech gain, or insufficient amplifier loading.

2

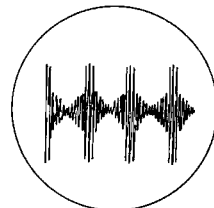

Pure CW carrier or perfect single tone input on SSB. May also occur on single tone SSB with excessive drive which results in amplifier "flat topping." Note absence of fine ripple.

3

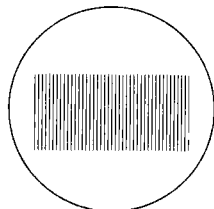

SSB signal, single tone input, sideband suppression down approximately 40 db or CW signal with spurious radiation down approximately 40 db.

4

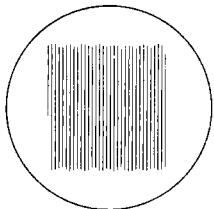

Same as 4 except down approximately 20 db. In SSB, the poor suppression may be due to audio unbalance or improper RF phase shift.

5

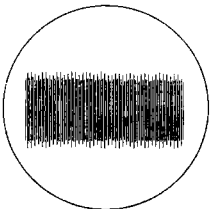

Same as 4, down approximately 10 db.

6

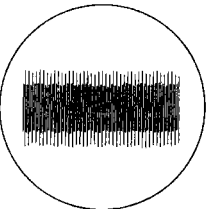

SSB signal, single tone input with carrier leakage. This pattern will have half the number of ripples due to poor sideband suppression. (See waveform 5.)

7

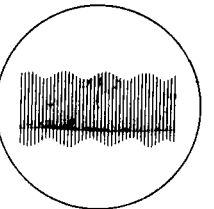

SSB signal, single tone input. Distortion in audio oscillator or audio system, balanced modulator detuned, or insufficient RF in balanced modulator.

8

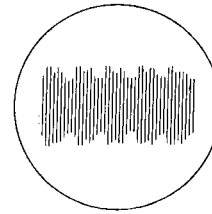

SSB signal, single tone input. Very little sideband suppression. Caused by defective modulator tube; audio phase shift network; 90 degrees RF phase shift component; partially shorted modulation transformer; secondary of transformer that feeds audio phase shift network shorted to ground; crystal oscillating on two adjacent frequencies simultaneously or both heterodyne oscillators on together.

9

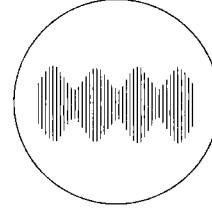

Normal double sideband, single tone input.

SSB signal, single tone input with no sideband suppression. May be due to one modulator tube dead, modulation transformer open or shorted, defective bandpass filter.

10

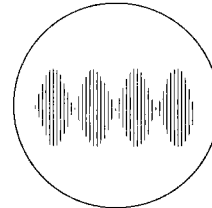

Normal SSB signal, two tone input, tones properly adjusted for equal amplitude.

SSB with carrier, single tone input. Incorrect value of carrier or modulation. Excessively rounded tops would indicate too much carrier.

11

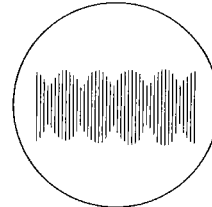
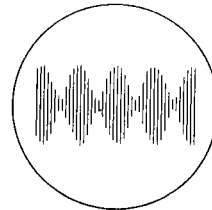

Plate modulated AM, or double sideband with carrier inserted, single tone input. Nearly 100% modulated. Excellent waveform.

12



Double sideband with carrier inserted (low level AM), single tone input. Too much carrier inserted. Note that the positive peaks flatten before a fine base line is obtained. Peak flattening may also be caused by insufficient antenna loading, insufficient interstage loading, an overdriven linear amplifier, poor dynamic power supply regulation, etc.

13

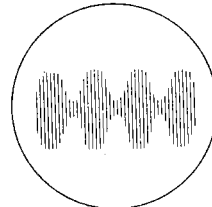

Double sideband with carrier inserted (low level AM), single tone input. Insufficient carrier insertion or excessive audio, resulting in high distortion (overmodulated). Also called Double Sideband Reduced Carrier (DSRC).

14

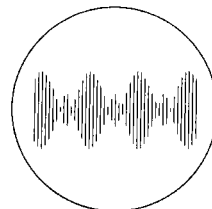

Low or high level AM with strong parasitics appearing on modulation peaks. Very fine, "Grassy" appearance on peaks would indicate parasitic in the UHF range.

15

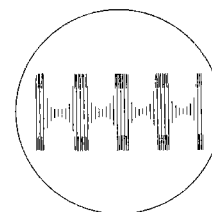

SSB, two tone input, or double sideband, single tone input; carrier leakage in either causes uneven height of successive half cycles of modulation envelope.

16

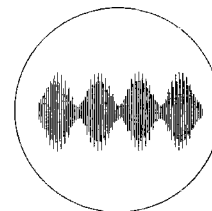

Low or high level AM, single tone input. Severe distortion in modulator system or AF tone generator, RF feedback to audio system, or RF feedback to previous low level stage.

17

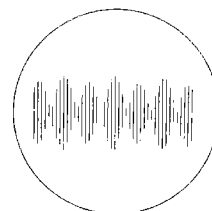

Nonlinearity in modulated RF stage, single tone input, due to insufficient excitation of a plate modulated stage, overdrive to a grid modulated stage, or insufficient antenna loading of a grid modulated stage.

18

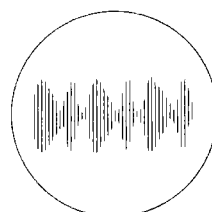

Plate modulated AM, single tone input. Overdriven modulator incapable of 100% modulation. May also result from deliberately "clipped" audio not properly filtered.

19

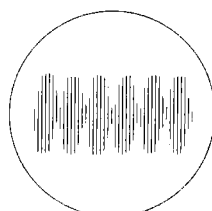
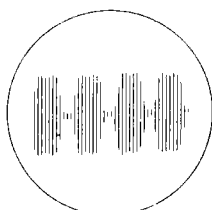
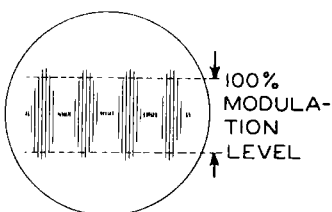

Plate modulated AM, single tone input. Modulator output more than ample. Modulation in excess of 100% in both directions.

20



21



TRAPEZOID PATTERNS

Plate modulation, single or double sideband with carrier, or RF trapezoid. Good linearity. Desirable pattern.

22

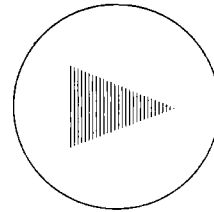

Plate, grid, or cathode modulation; double sideband or SSB with carrier. Modulation less than 100%. No distortion.

23

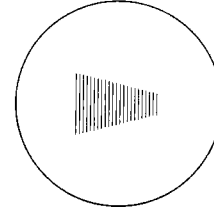

Nonlinear. With plate modulation, indicates lack of grid drive or insufficient grid bias. With grid modulation, SSB or DSB with carrier, or RF trapezoid through linear amplifier, indicates overdrive, insufficient antenna loading, grid current curvature or regeneration.

24

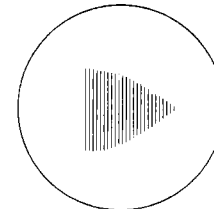

Plate modulation in excess of 100% in downward direction. Both modulator and final show good modulation capability.

25

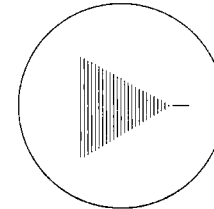

Plate modulation. Audio phase shift due to improper audio connection. Modulated approximately 80%.

26

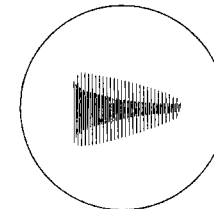

Plate modulation. Overmodulation in downward direction, with insufficient modulator capability.

27

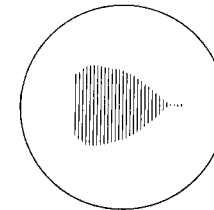
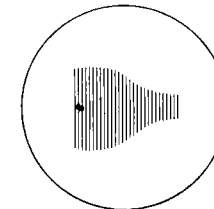

Plate modulation. Inadequate or mismatched modulator.

28



Nonlinear. With plate modulation this indicates regeneration due to improper neutralization. In linear operation this also indicates regeneration, or excessive grid bias.

29

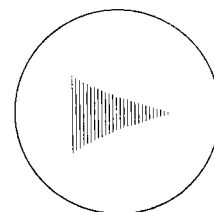

Parasitics occuring on modulation peaks.

30

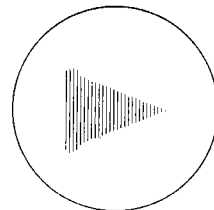

Screen grid or suppressor grid modulation, maximum modulation capability.

31

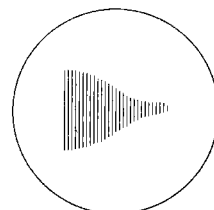

Grid modulation with improper neutralization and reactive load.

32

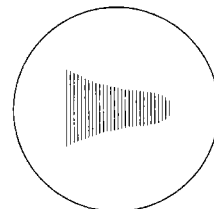

Unmodulated carrier. Can be caused by:
 No signal at horizontal deflection plates.
 Tone test oscillator inoperative.
 Gain control turned off on transmitter or oscilloscope.
 Audio failure in transmitter.

33

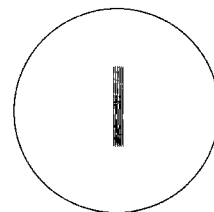

RTTY CROSS PATTERNS

Mark only. The relative narrowness of the ellipse provides good indication of the channel separation capability in the terminal unit.

34

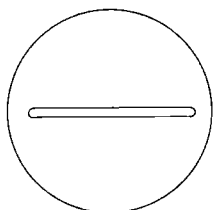

Space only. The relative narrowness of the ellipse provides good indication of the channel separation capability in the terminal unit.

35

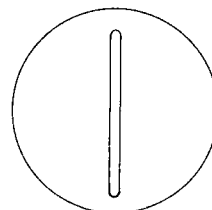

RTTY signal, proper shift, correctly tuned in.

36

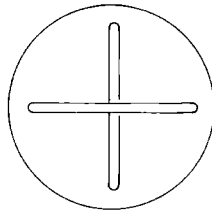

Incorrect shift, space tuned in.

37

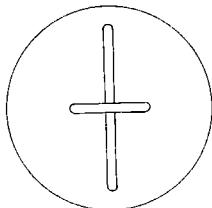

Incorrect shift, mark tuned in.

38

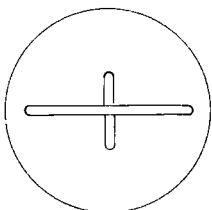

"Straddle" tuning of incorrect shift.

39

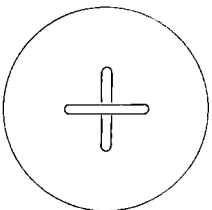

CW PATTERNS

Good CW pattern, properly shaped keying, string of dots. Pattern can be approximately "locked" using automatic keyer or bug.

40

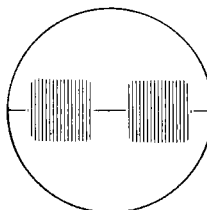

CW pattern showing effect of receiver AVC action or poor power supply regulation in the transmitter.

41

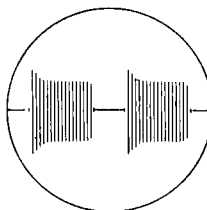

CW pattern, mild key clicks.

42

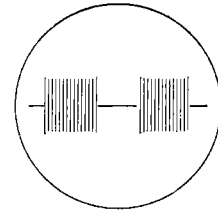

CW pattern, severe key clicks.

43

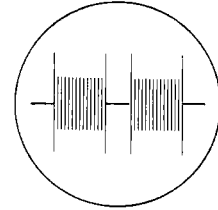

CW pattern with considerable backwave, RTTY transmitter pattern with unequal mark and space outputs, or RTTY receiver pattern with signal not properly centered in IF bandpass, or bandpass too narrow.

44

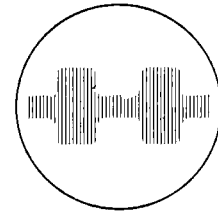

CW pattern, string of dots indicating poor contacts or contact bounce in keying mechanism.

45

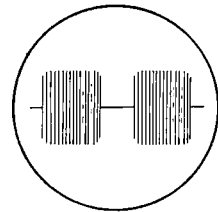

IN CASE OF DIFFICULTY

1. Recheck the wiring. Trace each lead in colored pencil on the Pictorial as it is checked. It is frequently helpful to have a friend check your work. Someone who is not familiar with the unit may notice something consistently overlooked by the constructor.
2. It is interesting to note that about 90% of the kits that are returned for repair, do not function properly due to poor connections and soldering. Therefore, many troubles can be eliminated by reheating all connections to make sure that they are soldered as described in the Proper Soldering Techniques section of this manual.
3. Check to be sure that all tubes are in their proper locations. Make sure that all tubes light up properly.
4. Check the tubes with a tube tester or by substitution of tubes of the same types and known to be good.
5. Check the values of the parts. Be sure that the proper part has been wired into the circuit, as shown in the pictorial diagrams and as called out in the wiring instructions.
6. Check for bits of solder, wire ends or other foreign matter which may be lodged in the wiring.
7. If, after careful checks, the trouble is still not located and a voltmeter is available, check voltage readings against those shown on the Schematic Diagram. NOTE: All voltage readings were taken with an 11 megohm input vacuum tube voltmeter. Voltages may vary as much as 10%.
8. A review of the Circuit Description will prove helpful in indicating where to look for trouble.

TROUBLESHOOTING CHART	
TROUBLE	SUGGESTED TEST
Tube filaments do not light.	Check fuses. Check filament voltage.
No trace or spot.	Check clamper circuit voltages and tube. Check for high voltage.
No vertical deflection.	Check vertical tube and voltages.
No horizontal deflection.	Check horizontal and sweep tube and voltages.
A tube filament does not light.	Check tube. Check filament wiring
No B+.	Check fuses. Check silicon diodes. Check for open resistors, shorted capacitors or defective tubes.
Poor focusing.	Check V6. Check high voltage bleeder resistors: R44, R45, R47, R48, and R49. Check C30 and C31. Some astigmatism - defocusing at ends of trace - may be noted. This is normal, and should not interfere with the monitoring function.
Distorted waveform.	Too much signal input.
Unable to obtain tone waveform.	Check test jumper for proper installation. See Detail 18A and the preceding step. Vertical gain control not fully clockwise. Check wiring and voltages of V4 (6J11).

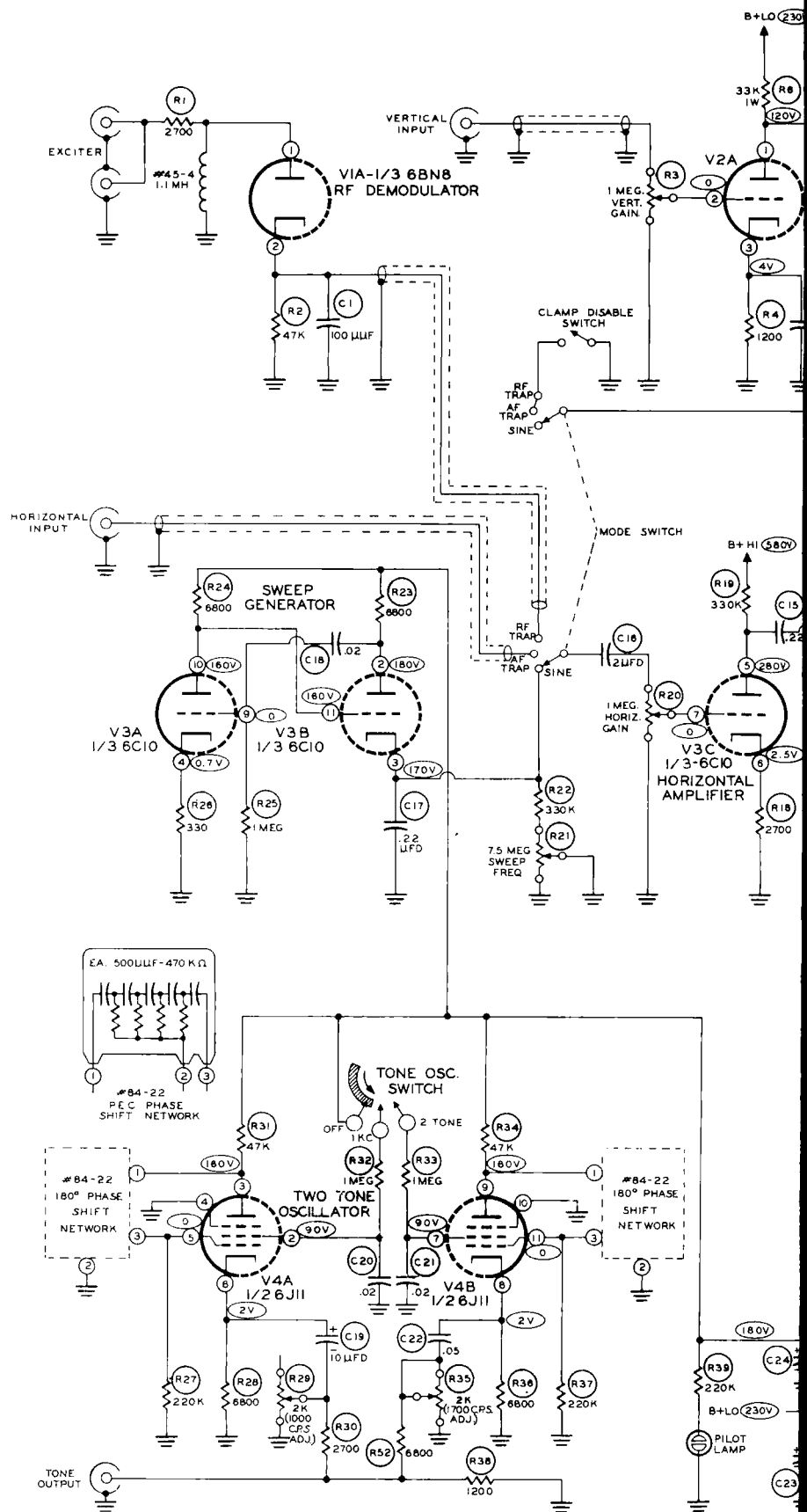

SCHEMATIC OF THE
HEATHKIT®
MONITOR SCOPE
MODEL HO-10

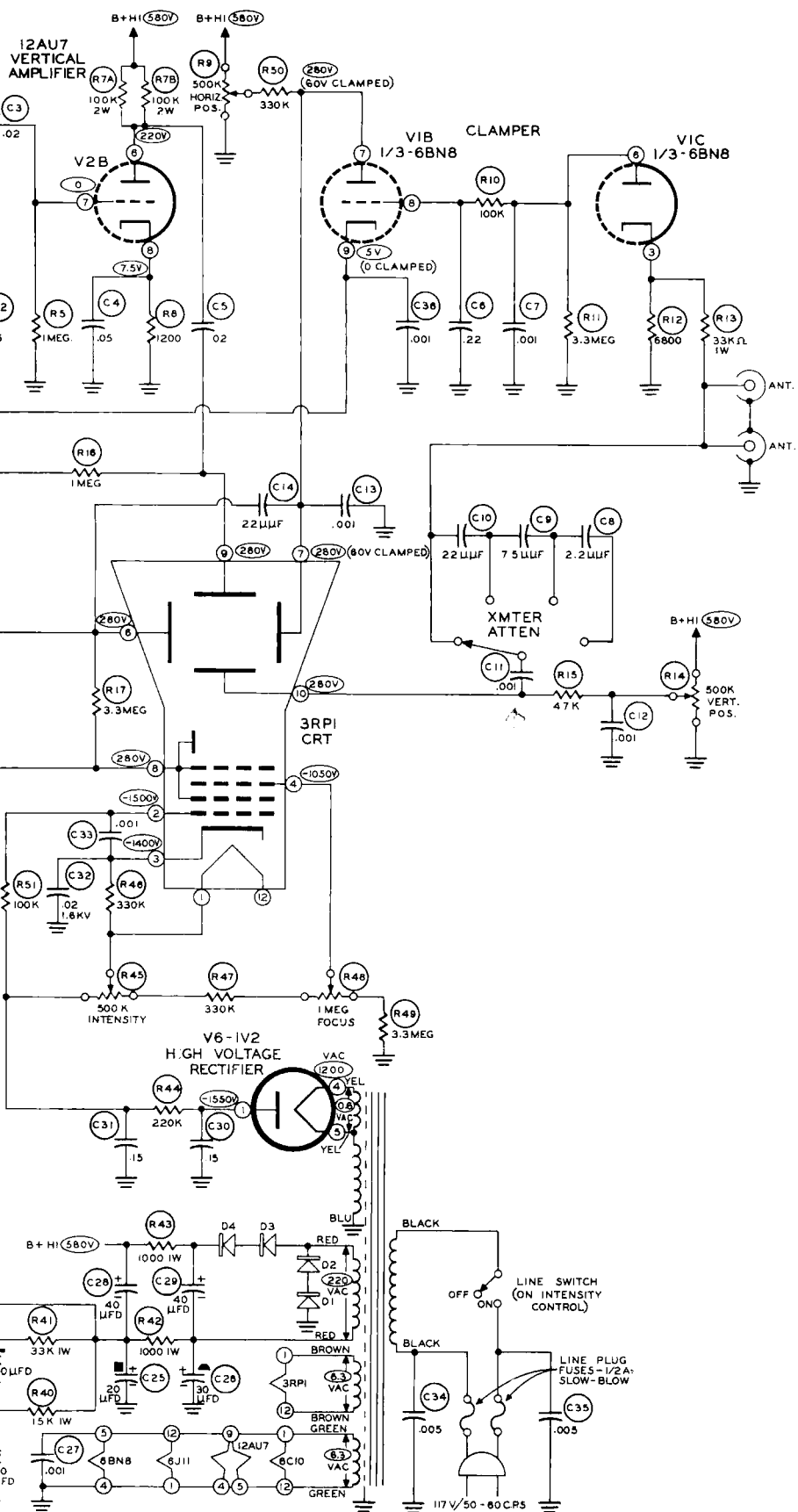

NOTES:
 ALL SWITCHES IN FULLY COUNTERCLOCKWISE POSITION AS VIEWED FROM SHAFT END.
 ⊙ INDICATES VOLTAGE.
 ALL VOLTAGES MEASURED WITH 20,000 Ω/VOLT (OR HIGHER) METER.
 ALL VOLTAGES MEASURED FROM POINT INDICATED TO GROUND EXCEPT AC TRANSFORMER VOLTAGES.
 ALL RESISTORS 1/2 WATT UNLESS OTHERWISE SHOWN.
 ALL CAPACITORS LISTED ARE IN μF UNLESS OTHERWISE SHOWN.

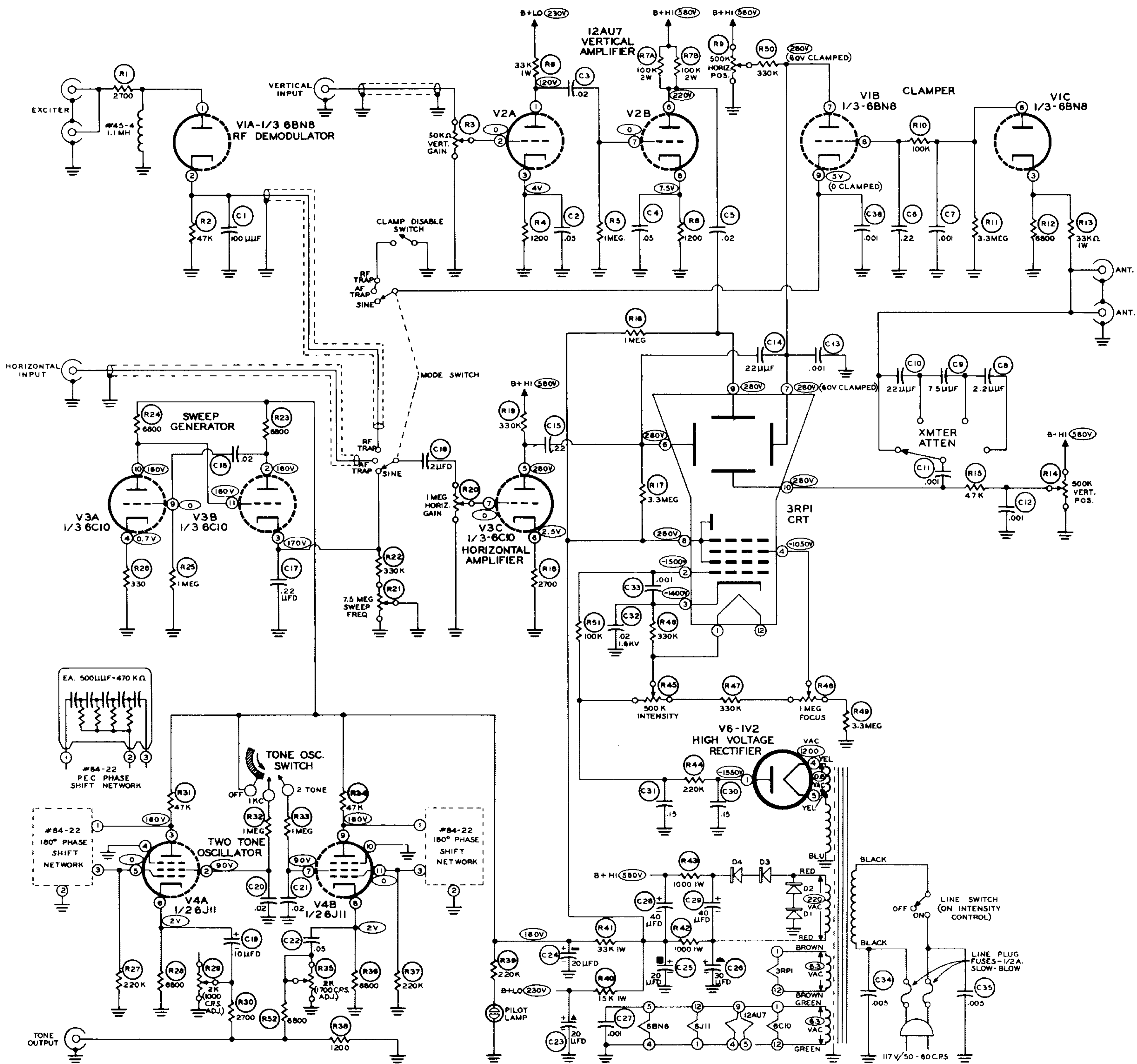

**SCHEMATIC OF THE
HEATHKIT®
AUDIO ANALYZER
MONITOR SCOPE
MODEL HO-10**

NOTES:

ALL SWITCHES FULL COUNTERCLOCKWISE AS VIEWED FROM FRONT.
 ○ INDICATES VOLTAGE.
 ALL VOLTAGES MEASURED WITH 20,000Ω/VOLT (OR HIGHER) METER.
 ALL VOLTAGES MEASURED FROM POINT INDICATED TO GROUND EXCEPT AC TRANSFORMER VOLTAGES.
 ALL RESISTORS 1/2 WATT UNLESS OTHERWISE SHOWN.
 ALL CAPACITORS LISTED ARE IN μF UNLESS OTHERWISE SHOWN.